



LEDTECH ELECTRONICS CORP.

NANYA ROAD, MUGANG ZHAOQING
CITY GUANGDONG CHINA.

TEL: 86-758-2875541, 2870651, 2877464, 2876185, 2877017

FAX: 86-758-2878014

[Http://www.ledtech.com.tw](http://www.ledtech.com.tw)

SPECIFICATION

PART NO. : LT5241RE-81

2.0×5.0mm RECTANGULAR LED LAMP



Approved by

Checked by

Prepared by

Tung

Yang

Min Bao

Description

This orange lamp is made with GaAsP/GaP chip and red diffused epoxy resin.

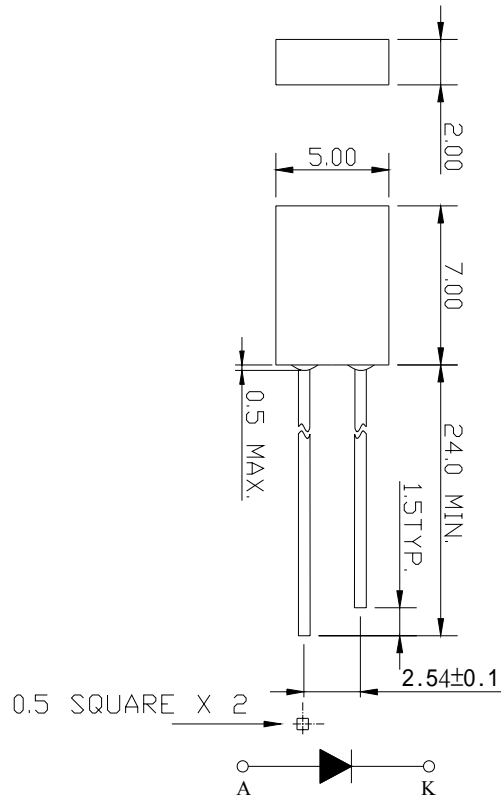

Notes:

1. All dimensions are in mm.
2. Tolerance is ± 0.25 mm unless otherwise noted.

Description

Part No.	LED Chip		Lens Color
	Material	Emitting Color	
LT5241RE-81	GaAsP/GaP	Orange	Red diffused

Absolute Maximum Ratings at Ta=25

Parameter	Symbol	Rating	Unit
Power Dissipation	PD	78	mW
Reverse Voltage	VR	5	V
D.C. Forward Current	If	30	mA
Reverse (Leakage) Current	Ir	100	μA
Peak Current(1/10Duty Cycle,0.1ms Pulse Width.)	If(Peak)	100	mA
Operating Temperature Range	Topr.	-25 to +85	
Storage Temperature Range	Tstg.	-40 to +100	
Soldering Temperature(1.6mm from body)	Tsol.	Dip Soldering : 260 for 5 sec. Hand Soldering : 350 for 3 sec.	

Electrical and Optical Characteristics:

Parameter	Symbol	Condition	Min.	Typ.	Max.	Unit
Luminous Intensity	Iv	If=20mA	3.0	6.0		mcd
Forward Voltage	Vf	If=20mA		2.1	2.6	V
Peak Wavelength	λp	If=20mA		635		nm
Dominant Wavelength	λd	If=20mA		626		nm
Reverse (Leakage) Current	Ir	VR=5V			100	μA
Viewing Angle	2 1/2	If=20mA		125		deg
Spectrum Line Halfwidth	Δλ	If=20mA		35		nm

Notes:1. The datas tested by IS tester.

2. Customer's special requirements are also welcome

Typical Electrical / Optical Characteristics Curves :

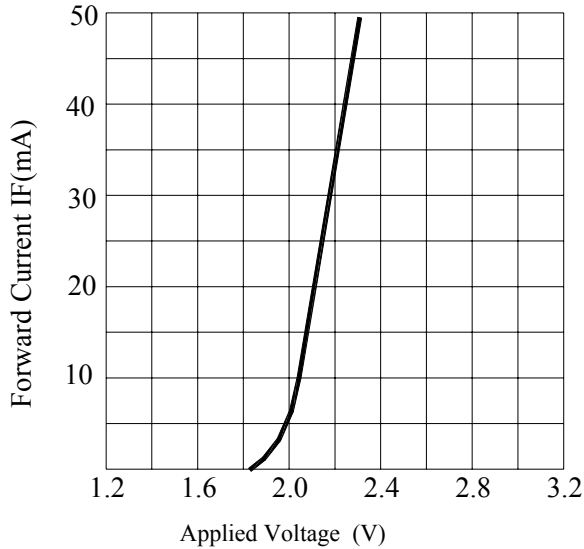

FORWARD CURRENT VS. APPLIED VOLTAGE

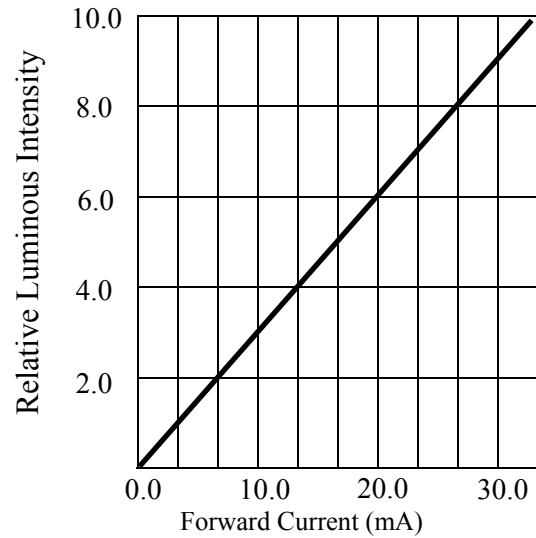

FORWARD CURRENT VS. LUMINOUS INTENSITY

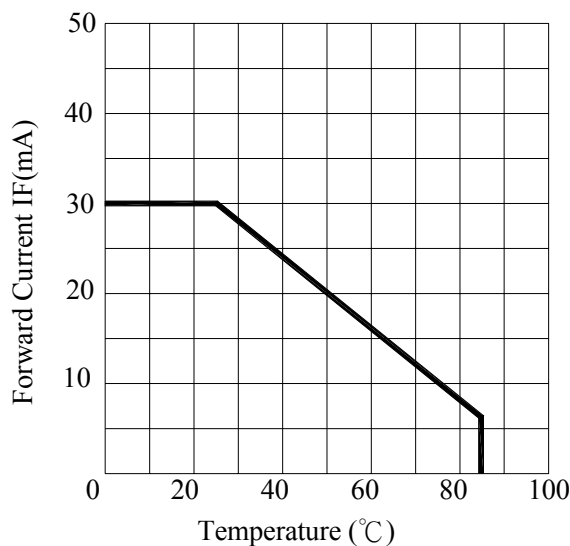

FORWARD CURRENT VS. AMBIENT TEMPERATURE

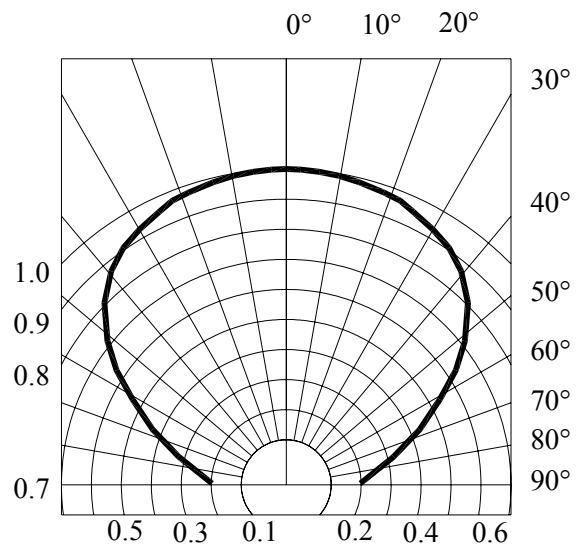

RADIATION DIAGRAM

Precautions:

TAKE NOTE OF THE FOLLOWING IN USE OF LED

1. Temperature in use

Since the light generated inside the LED needs to be emitted to outside efficiently, a resin with high light transparency is used; therefore, additives to improve the heat resistance or moisture resistance (silica gel, etc) which are used for semiconductor products such as transistors cannot be added to the resin.

Consequently, the heat resistant ability of the resin used for LED is usually low; therefore, please be careful on the following during use.

Avoid applying external force, stress, and excessive vibration to the resins and terminals at high temperature. The glass transition temperature of epoxy resin used for the LED is approximately 120-130 .

At a temperature exceeding this limit, the coefficient of linear expansion of the resin doubles or more compared to that at normal temperature and the resin is softened.

If external force or stress is applied at that time, it may cause a wire rupture.

2. Soldering

Please be careful on the following at soldering.

After soldering, avoid applying external force, stress, and excessive vibration until the products go to cooling process (normal temperature), <Same for products with terminal leads>

(1) Soldering measurements:

Distance between melted solder side to bottom of resin shall be 1.6mm or longer.

(2) Dip soldering :

Pre-heat: 90 max. (Backside of PCB), Within 60 seconds.

Solder bath: 260±5 (Solder temperature), Within 5 seconds.

(3) Soldering iron : 250 max. (Temperature of soldering iron tip), Within 3 seconds

3. Insertion

Pitch of the LED leads and pitch of mounting holes need to be same

4. Others

Since the heat resistant ability of the LED resin is low, SMD components are used on the same PCB, please mount the LED after adhesive baking process for SMD components. In case adhesive baking is done after LED lamp insertion due to a production process reason, make sure not to apply external force, stress, and excessive vibration to the LED and follow the conditions below.

Baking temperature: 120 max. Baking time: Within 60 seconds

If soldering is done sequentially after the adhesive baking, please perform the soldering after cooling down the LED to normal temperature.

ENCASED TYPE

PLASTIC PACKAGE

QUANTITY: 1000 PCS

LEDTECH ELECTRONICS CORP.
 PART NO :LTXXXX-XX
 Q'TY : PCS
 LOT NO :XXXXXXXXXX
 DATE :
 BIN CODE:

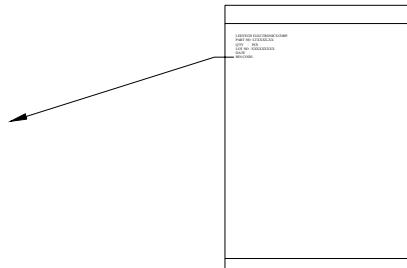

INNER BOX

QUANTITY: 10 PACKETS

TOTAL: 10,000 PCS

PART NO.	LXXXXX-XX-XX				
LOT NO.	XXXXXXXXXX				
BIN CODE	Xx X	Xx X	Xx X	Xx X	TOTAL
QUANTITY	PCS	PCS	PCS	PCS	PCS
DATE	XXXX, XX, XX				

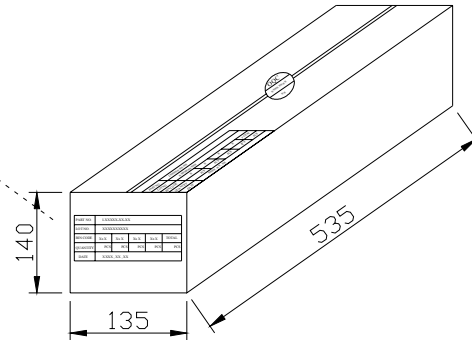

OUTER CARTON

QUANTITY: 4 BOX

TOTAL: 40,000 PCS

C/T NO. 箱 號	XX
PART NO. 料 號	LXXXXX-XX-XX
QUANTITY 數 量	PCS
N.W. 淨 重	KGS
G.W. 毛 重	KGS
REMARK 備 註	

