

Power Metal Film Resistors

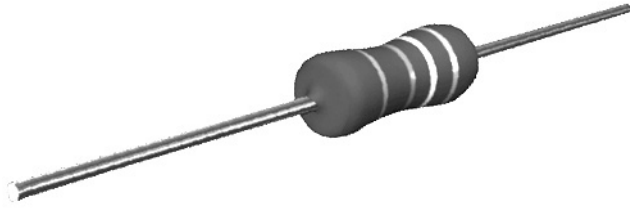

DESCRIPTION

A homogeneous film of metal alloy is deposited on a high grade ceramic body. After a helical groove has been cut in the resistive layer, tinned connecting wires of electrolytic copper or copper-clad iron are welded to the end-caps. The resistors are coated with a red, nonflammable lacquer which provides electrical, mechanical and climatic protection. This coating is not resistant to aggressive fluxes. The encapsulation is resistant to all cleaning solvents in accordance with "MIL-STD-202E, method 215", and "IEC 60068-2-45".

FEATURES

- High power in small packages (1 W/0207 size to 3 W/0617 size)
- Different lead materials for different applications
- Defined interruption behaviour
- Lead (Pb)-free solder contacts
- Pure tin plating provides compatibility with lead (Pb)-free and lead containing soldering processes
- Compatible with "Restriction of the use of Hazardous Substances" (RoHS) directive 2002/95/EC (issue 2004)



APPLICATIONS

- All general purpose power applications

TECHNICAL SPECIFICATIONS

DESCRIPTION	VALUE				
	PR01	PR02		PR03	
		Cu-lead	FeCu-lead	Cu-lead	FeCu-lead
Resistance Range ⁽²⁾	0.22 Ω to 1 MΩ	0.33 Ω to 1 MΩ	1 Ω to 1 MΩ	0.68 Ω to 1 MΩ	1 Ω to 1 MΩ
Resistance Tolerance and Series	± 1 % (E24, E96 series); ± 5 % (E24 series) ⁽¹⁾				
Maximum Dissipation at $T_{amb} = 70\text{ °C}$:					
$R < 1\ \Omega$	0.6 W	1.2 W	-	1.6 W	-
$1\ \Omega \leq R$	1 W	2 W	1.3 W	3 W	2.5 W
Thermal Resistance (R_{th})	135 K/W	75 K/W	115 K/W	60 K/W	75 K/W
Temperature Coefficient	$\leq \pm 250 \times 10^{-6}/K$				
Maximum Permissible Voltage (DC or RMS)	350 V	500 V		750 V	
Basic Specifications	IEC 60115-1 and 60115-4				
Climatic Category (IEC 60068)	55/155/56				
Stability After:					
Load	$\Delta R\ max.: \pm (5\ %\ R + 0.1\ \Omega)$				
Climatic Tests	$\Delta R\ max.: \pm (3\ %\ R + 0.1\ \Omega)$				
Soldering	$\Delta R\ max.: \pm (1\ %\ R + 0.05\ \Omega)$				

Notes:

- ⁽¹⁾ 1 % tolerance is available for R_n -range from 1 R upwards
⁽²⁾ Ohmic values (other than resistance range) are available on request
 • R value is measured with probe distance of 24 ± 1 mm using 4-terminal method

12NC INFORMATION

The resistors have a 12-digit numeric code starting with 23
 For 5 % tolerance:

- The next 7 digits indicate the resistor type and packing
- The remaining 3 digits indicate the resistance value:
 - The first 2 digits indicate the resistance value
 - The last digit indicates the resistance decade

For 1 % tolerance:

- The next 6 digits indicate the resistor type and packing
- The remaining 4 digits indicate the resistance value:
 - The first 3 digits indicate the resistance value
 - The last digit indicates the resistance decade

Last Digit of 12NC Indicating Resistance Decade

RESISTANCE DECADE	LAST DIGIT
0.22 to 0.91 Ω	7
1 to 9.76 Ω	8
10 to 97.6 Ω	9
100 to 976 Ω	1
1 to 9.76 kΩ	2
10 to 97.6 kΩ	3
100 to 976 kΩ	4
1 MΩ	5

12NC Example

The 12NC for resistor type PR02 with Cu leads and a value of 750 Ω with 5 % tolerance, supplied on a bandolier of 1000 units in ammopack, is: 2306 198 53751.



12NC - Resistor Type and Packaging ⁽¹⁾								
TYPE	LEAD Ø mm	TOL (%)	ORDERING CODE 23.. (BANDOLIER)					
			AMMOPACK				REEL	
			RADIAL TAPED		STRAIGHT LEADS			
			4000 units	3000 units	52 mm 5000 units	52 mm 1000 units	63 mm 500 units	52 mm 5000 units
PR01	Cu 0.6	1	-	-	22 196 1...	06 191 2...	-	06 191 5...
		5	06 197 03...	-	22 193 14...	06 197 53...	-	06 197 23...
PR02	Cu 0.8	1	-	22 197 2...	-	22 197 1...	-	06 192 5...
		5	-	06 198 03...	-	06 198 53...	-	06 198 23...
PR03	Cu 0.8	5	-	-	-	-	22 195 14...	-
		1	-	-	-	-	06 199 6...	-
		5	-	-	-	-	22 195 54...	-

Notes:

- ⁽¹⁾ Other packaging versions are available on request
- Preferred types in bold

12NC - Resistor Type and Packaging						
TYPE	LEAD Ø mm	TOL (%)	ORDERING CODE 23.. (LOOSE IN BOX)			
			DOUBLE KINK			
			PITCH = 17.8 mm	PITCH = 25.4 mm	PITCH ⁽²⁾ ⁽³⁾ ⁽⁴⁾	
			1000 units	500 units	1000 units	500 units
PR01	Cu 0.6	5	22 193 03...	-	-	-
	FeCu 0.6	5	22 193 43...	-	22 193 53... ⁽²⁾	-
PR02	Cu 0.8	5	22 194 23...	-	-	-
	FeCu 0.6	5	22 194 83...	-	-	-
	FeCu 0.8	5	-	-	22 194 63... ⁽³⁾	-
PR03	Cu 0.8	5	-	22 195 23...	-	-
	FeCu 0.6	5	-	22 195 83...	-	-
	FeCu 0.8	5	-	-	-	22 195 63... ⁽⁴⁾

Notes:

- ⁽²⁾ PR01 pitch 12.5 mm
- ⁽³⁾ PR02 pitch 15.0 mm
- ⁽⁴⁾ PR03 pitch 20.0 mm, with reversed kinking direction as opposed to the drawing for the type with double kink figure
- Preferred types in bold

PART NUMBER AND PRODUCT DESCRIPTION																									
PART NUMBER: PR02000201001JA100																									
<table border="1" style="width:100%; text-align:center;"> <tr> <td>P</td><td>R</td><td>0</td><td>2</td><td>0</td><td>0</td><td>0</td><td>2</td><td>0</td><td>1</td><td>0</td><td>0</td><td>1</td><td>J</td><td>A</td><td>1</td><td>0</td><td>0</td> </tr> </table>								P	R	0	2	0	0	0	2	0	1	0	0	1	J	A	1	0	0
P	R	0	2	0	0	0	2	0	1	0	0	1	J	A	1	0	0								
MODEL/SIZE	SPECIAL CHARACTE	WIRE TYPES	TCR/MATERIAL	VALUE	TOLERANCE	PACKAGING ⁽¹⁾	SPECIAL																		
PR0100 PR0200 PR0300	0 = Neutral Z = Value overflow (Special)	1 = Cu 0.6 2 = Cu 0.8 3 = FeCu 0.6 4 = FeCu 0.8	0 = Standard	3 digit value 1 digit multiplier MULTIPLIER 7 = *10 ⁻³ 2 = *10 ² 8 = *10 ⁻² 3 = *10 ³ 9 = *10 ⁻¹ 4 = *10 ⁴ 0 = *10 ⁰ 5 = *10 ⁵ 1 = *10 ¹	F = ± 1 % J = ± 5 %	N4 R5 N3 L1 A5 DC A1 K1 AC B1 R5 PC	The 2 digits are used for all special parts. 00 = Standard																		
PRODUCT DESCRIPTION: PR02 5 % A1 1K0																									
PR02	5 %	A1	1K0																						
MODEL/SIZE	TOLERANCE	PACKAGING ⁽¹⁾	RESISTANCE VALUE																						
PR01 PR02 PR03	± 1 % ± 5 %	N4 L1 N3 DC A5 K1 A1 B1 AC PC R5	1K0 = 1 kΩ 4K75 = 4.75 kΩ																						

Notes:

- ⁽¹⁾ Please refer to table PACKAGING for details
- The PART NUMBER is shown to facilitate the introduction of a unified part numbering system for ordering products

PACKAGING			
CODE	PIECES	DESCRIPTION	MODEL/SIZE
N4	4000	Bandolier in ammpack radial taped	PR01
N3	3000	Bandolier in ammpack radial taped	PR02
A5	5000	Bandolier in ammpack straight leads 52 mm	PR01
A1	1000	Bandolier in ammpack straight leads 52 mm	PR01, PR02
AC	500	Bandolier in ammpack straight leads 63 mm	PR03
R5	5000	Bandolier on reel straight leads 52 mm	PR01, PR02
L1	1000	Loose in box with Double Kink, pitch 17.8 mm	PR01, PR02
DC	500	Loose in box with Double Kink, pitch 25.4 mm	PR03
K1	1000	Loose in box with Double Kink, pitch 12.5 mm	PR01
B1	1000	Loose in box with Double Kink, pitch 15.0 mm	PR02
PC	500	Loose in box with Double Kink, pitch 20.0 mm	PR03

DIMENSIONS

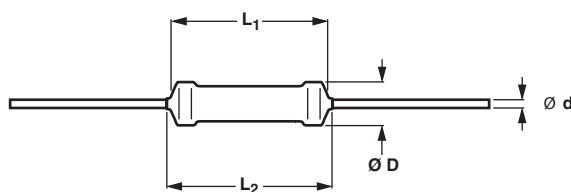

Type with straight leads

DIMENSIONS - straight lead type and relevant physical dimensions; see straight leads outline					
TYPE	Ø D _{max.} (mm)	L ₁ max. (mm)	L ₂ max. (mm)	Ø d (mm)	
				Cu	FeCu
PR01	2.5	6.5	8.5	0.58 ± 0.05	-
PR02	3.9	10.0	12.0	0.78 ± 0.05	0.58 ± 0.05
PR03	5.2	16.7	19.5	0.78 ± 0.05	0.58 ± 0.05

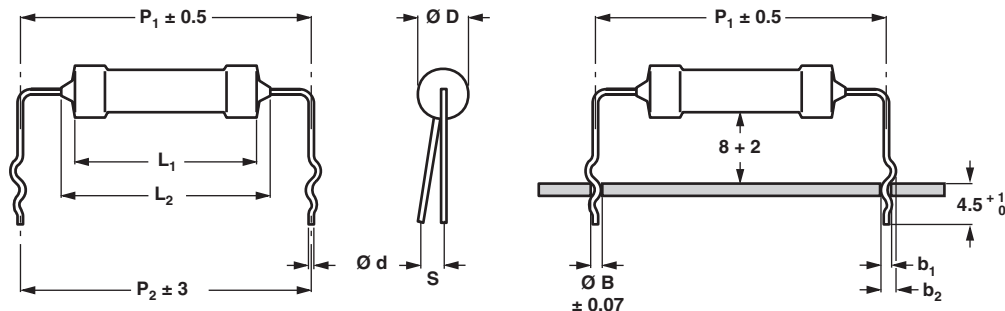

Type with double kink

Dimensions in millimeters

DIMENSIONS - double kink lead type and relevant physical dimensions; see double kinked outline										
TYPE	LEAD STYLE	Ø d (mm)		b ₁ (mm)	b ₂ (mm)	Ø D _{max.} (mm)	P ₁ (mm)	P ₂ (mm)	S _{max.} (mm)	Ø B (mm)
		Cu	FeCu							
PR01	double kink large pitch	0.58 ± 0.05	0.58 ± 0.05	1.10 + 0.25/- 0.20	1.45 + 0.25/- 0.20	2.5	17.8	17.8	2	0.8
	double kink small pitch	-	0.58 ± 0.05	1.10 + 0.25/- 0.20	1.45 + 0.25/- 0.20		12.5	12.5	2	0.8
PR02	double kink large pitch	0.78 ± 0.05	0.58 ± 0.05	1.10 + 0.25/- 0.20	1.45 + 0.25/- 0.20	3.9	17.8	17.8	2	0.8
	double kink small pitch	-	0.78 ± 0.05	1.30 + 0.25/- 0.20	1.65 + 0.25/- 0.20		15.0	15.0	2	1.0
PR03	double kink large pitch	0.78 ± 0.05	0.58 ± 0.05	1.10 + 0.25/- 0.20	1.65 + 0.25/- 0.20	5.2	25.4	25.4	2	1.0
	double kink small pitch	-	0.78 ± 0.05	1.30 + 0.25/- 0.20	2.15 + 0.25/- 0.20		22.0	20.0	2	1.0

MASS PER 100 UNITS	
TYPE	MASS (g)
PR01 Cu 0.6 mm	21.2
PR01 FeCu 0.6 mm	20.7
PR02 Cu 0.8 mm	50.4
PR02 FeCu 0.6 mm	40.6
PR02 FeCu 0.8 mm	49.6
PR03 Cu 0.8 mm	119.2
PR03 FeCu 0.6 mm	107.9
PR03 FeCu 0.8 mm	118.5

MARKING

The nominal resistance and tolerance are marked on the resistor using four colored bands in accordance with IEC publication 60062, "Color codes for fixed resistors".

OUTLINES

The length of the body (L₁) is measured by inserting the leads into holes of two identical gauge plates and moving these plates parallel to each other until the resistor body is clamped without deformation ("IEC publication 60294").

FUNCTIONAL DESCRIPTION

PRODUCT CHARACTERIZATION

Standard values of nominal resistance are taken from the E96/E24 series for resistors with a tolerance of ± 1 % or ± 5 %. The values of the E96/E24 series are in accordance with "IEC publication 60063".

FUNCTIONAL PERFORMANCE

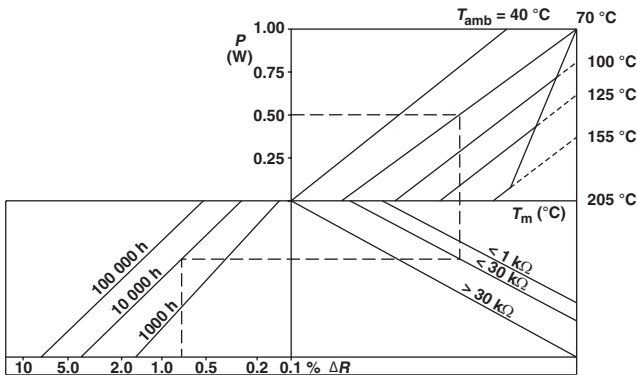

PR01 Drift nomogram

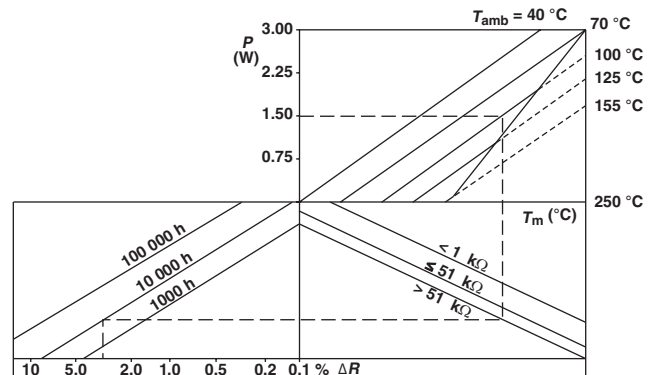

PR03 Drift nomogram

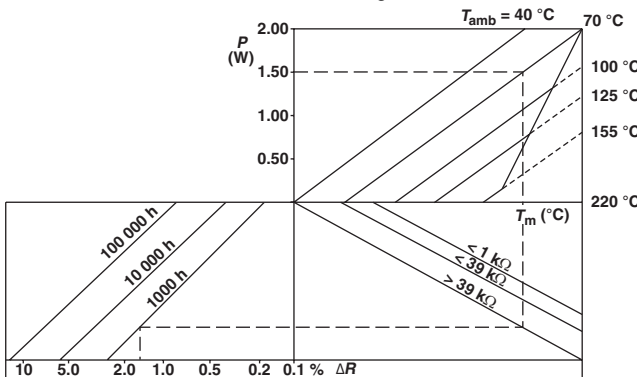

PR02 Drift nomogram

LIMITING VALUES

TYPE	LEAD MATERIAL	RANGE	LIMITING VOLTAGE ⁽¹⁾ (V)	LIMITING POWER (W)
PR01	Cu	$R < 1 \Omega$	350	0.6
		$1 \Omega \leq R$		1.0
PR02	Cu	$R < 1 \Omega$	500	1.2
		$1 \Omega \leq R$		2.0
	FeCu	$1 \Omega \leq R$		1.3
PR03	Cu	$R < 1 \Omega$	750	1.6
		$1 \Omega \leq R$		3.0
	FeCu	$1 \Omega \leq R$		2.5

Note:

- ⁽¹⁾ The maximum voltage that may be continuously applied to the resistor element, see "IEC publication 60115-1".
- The maximum permissible hot-spot temperature is 205 °C for PR01, 220 °C for PR02 and 250 °C for PR03.

MOUNTING

The resistors are suitable for processing on automatic insertion equipment and cutting and bending machines.

MOUNTING PITCH			
TYPE	LEAD STYLE	PITCH	
		mm	e
PR01	straight leads	12.5 ⁽¹⁾	5 ⁽¹⁾
	radial taped	4.8	2
	double kink large pitch	17.8	7
	double kink small pitch	12.5	5
PR02	straight leads	15.0 ⁽¹⁾	6 ⁽¹⁾
	radial taped	4.8	2
	double kink large pitch	17.8	7
	double kink small pitch	15.0	6
PR03	straight leads	23.0 ⁽¹⁾	9 ⁽¹⁾
	double kink large pitch	25.4	10
	double kink small pitch	20.0	8

Note:

- ⁽¹⁾ Recommended minimum value.



The power that the resistor can dissipate depends on the operating temperature.

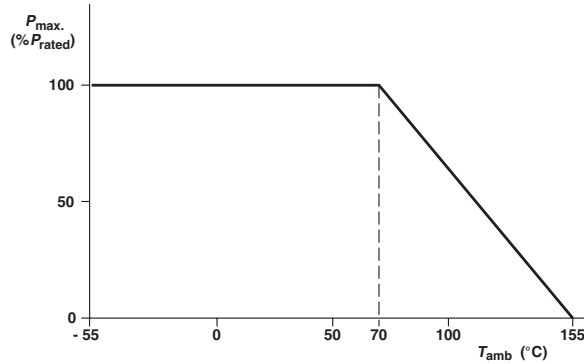

Maximum dissipation (P_{max}) in percentage of rated power as a function of the ambient temperature (T_{amb})

Derating

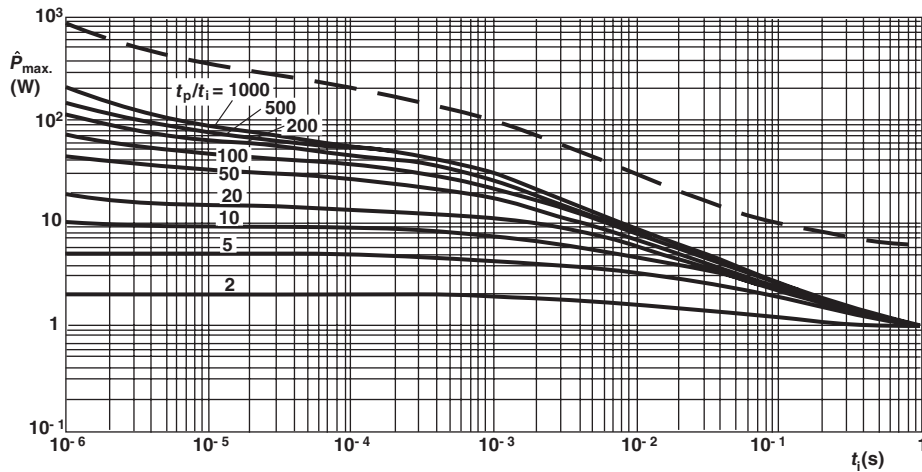

PR01 Pulse on a regular basis; maximum permissible peak pulse power (\hat{P}_{max}) as a function of pulse duration (t_i)

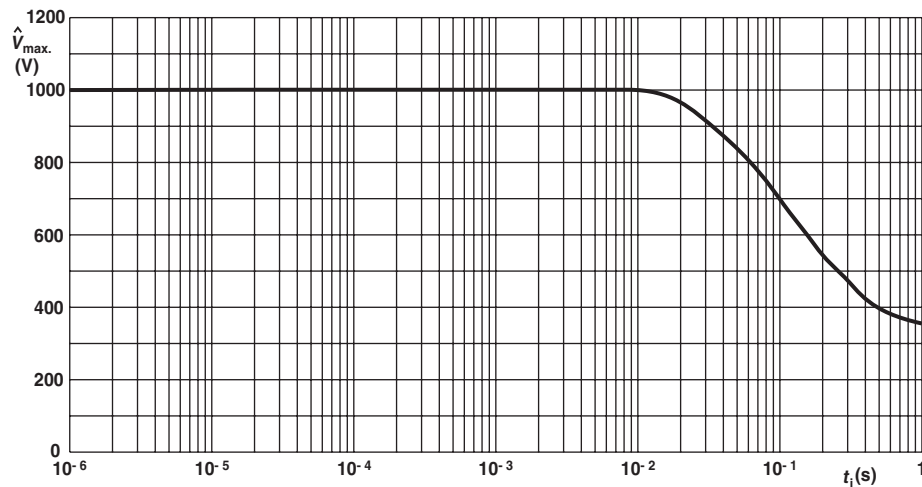

PR01 Pulse on a regular basis; maximum permissible peak pulse voltage (\hat{V}_{max}) as a function of pulse duration (t_i)

Pulse Loading Capabilities

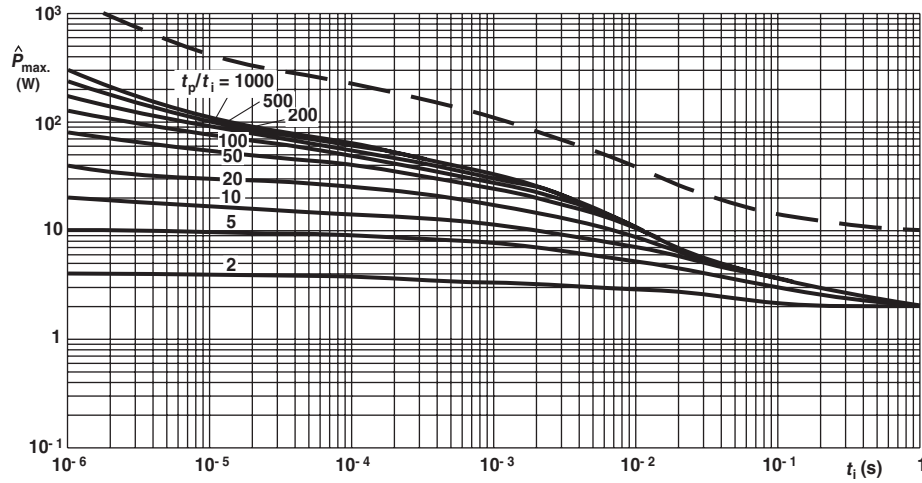

PR02 Pulse on a regular basis; maximum permissible peak pulse power ($\hat{P}_{max.}$) as a function of pulse duration (t_i)

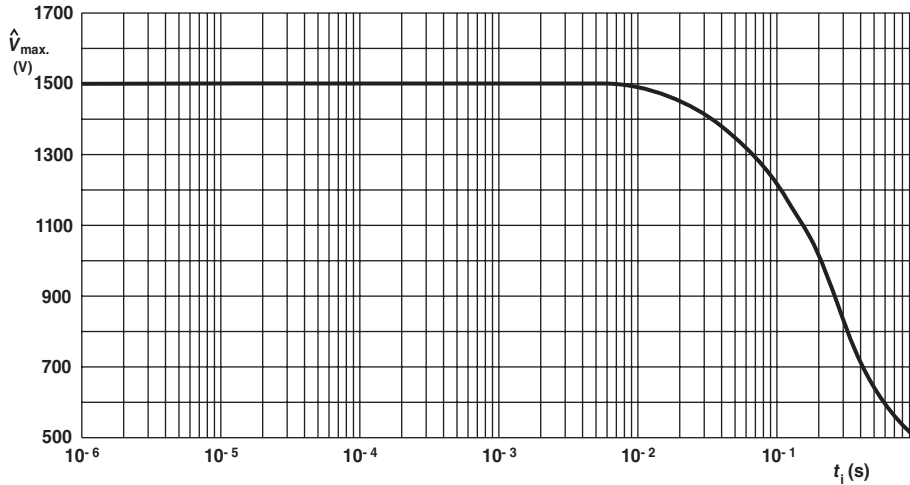

PR02 Pulse on a regular basis; maximum permissible peak pulse voltage ($\hat{V}_{max.}$) as a function of pulse duration (t_i)

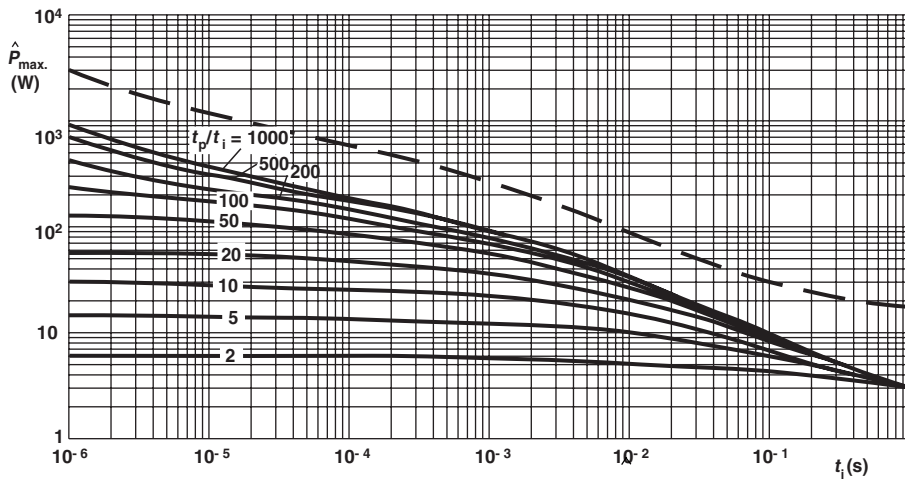

PR03 Pulse on a regular basis; maximum permissible peak pulse power ($\hat{P}_{max.}$) as a function of pulse duration (t_i)

Pulse Loading Capabilities

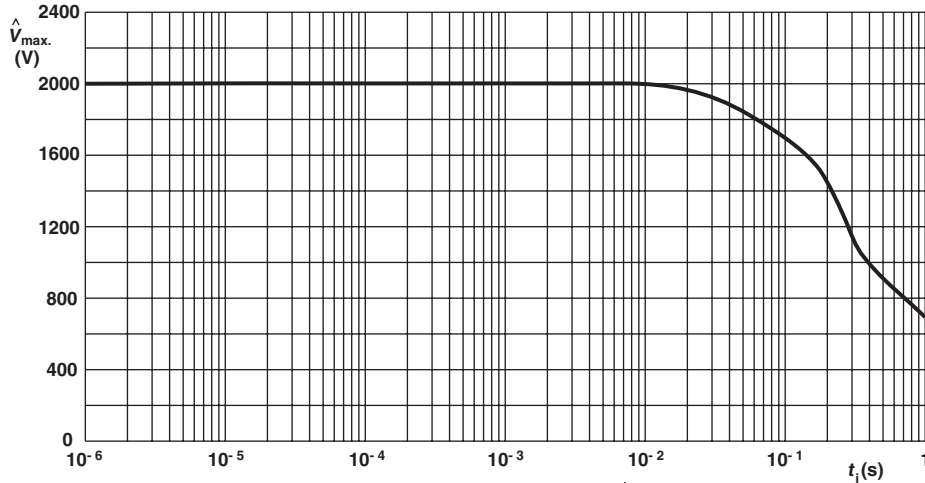

PR03 Pulse on a regular basis; maximum permissible peak pulse voltage (\hat{V}_{max}) as a function of pulse duration (t_i)

Pulse Loading Capabilities

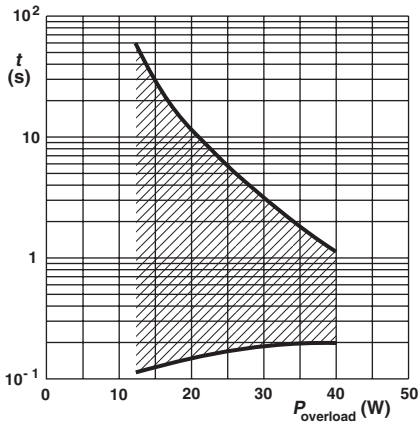

PR01 Time to interruption as a function of overload power for range: $0 R 22 \leq R_n < 1 R$

This graph is based on measured data under constant voltage conditions; the data may deviate according to the applications.

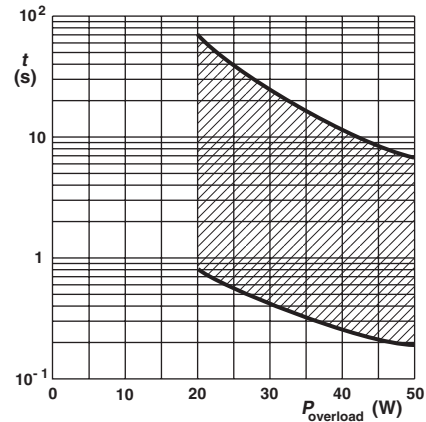

PR01 Time to interruption as a function of overload power for range: $16 R \leq R_n \leq 560 R$

This graph is based on measured data under constant voltage conditions; the data may deviate according to the applications.

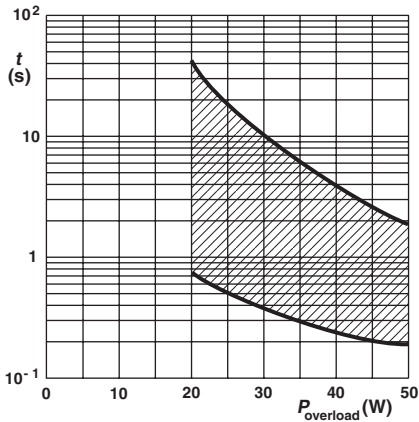

PR01 Time to interruption as a function of overload power for range: $1 R \leq R_n \leq 15 R$

This graph is based on measured data under constant voltage conditions; the data may deviate according to the applications.

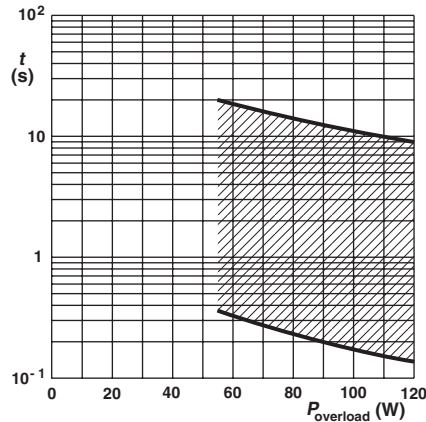

PR02 Time to interruption as a function of overload power for range: $0.33 R \leq R_n < 5 R$

This graph is based on measured data under constant voltage conditions; the data may deviate according to the applications.

Interruption Characteristics

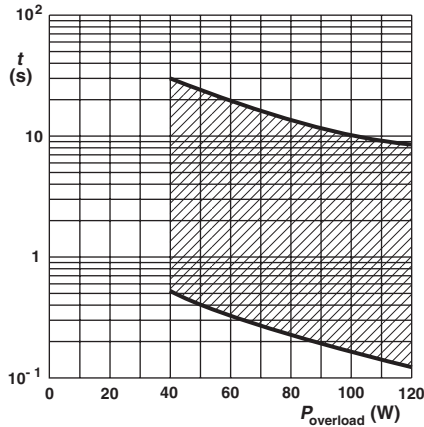

PR02 Time to interruption as a function of overload power for range: $5 R \leq R_n < 68 R$

This graph is based on measured data under constant voltage conditions; the data may deviate according to the applications.

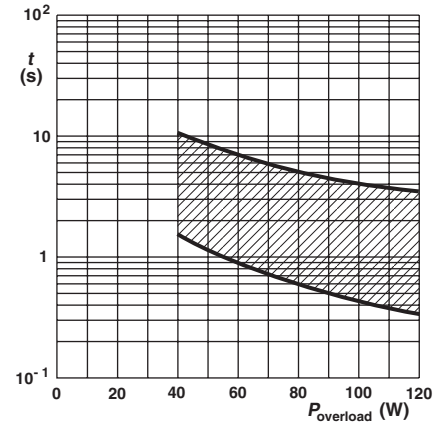

PR02 Time to interruption as a function of overload power for range: $68 R \leq R_n \leq 560 R$

This graph is based on measured data under constant voltage conditions; the data may deviate according to the applications.

Interruption Characteristics

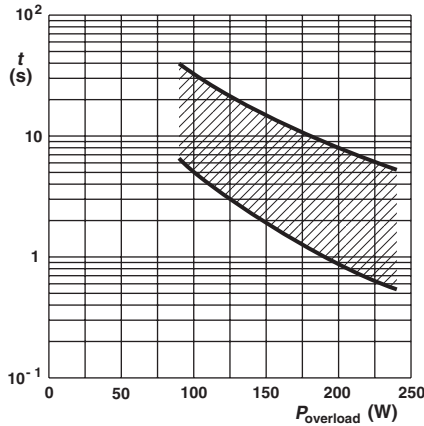

PR03 Time to interruption as a function of overload power for range: $0.68 R \leq R_n \leq 560 R$

This graph is based on measured data under constant voltage conditions; the data may deviate according to the applications.

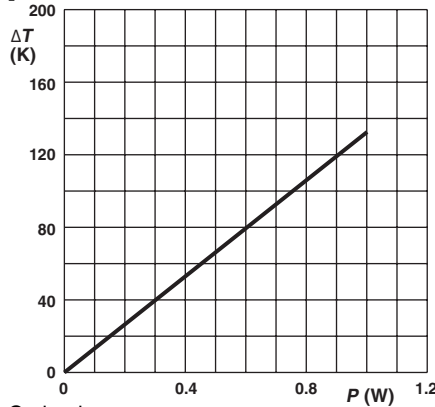

Ø 0.6 mm Cu-leads

PR01 Hot-spot temperature rise (ΔT) as a function of dissipated power.

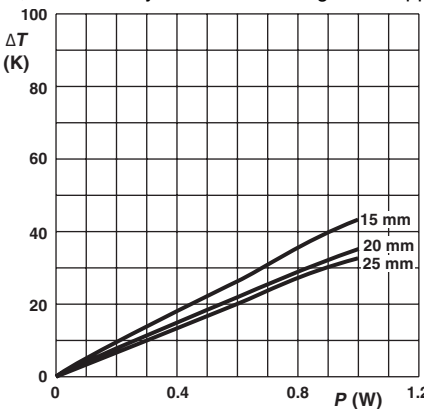

Ø 0.6 mm Cu-leads

Minimum distance from resistor body to PCB = 1 mm

PR01 Temperature rise (ΔT) at the lead end (soldering point) as a function of dissipated power at various lead lengths after mounting.

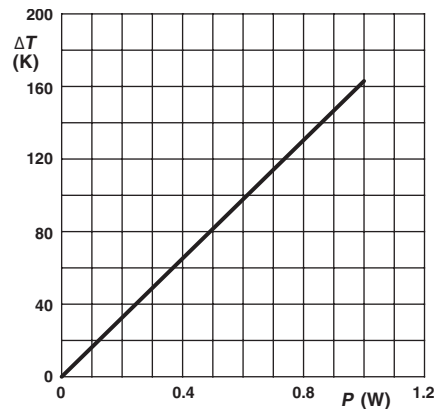

Ø 0.6 mm FeCu-leads

PR01 Hot-spot temperature rise (ΔT) as a function of dissipated power.

Application Information

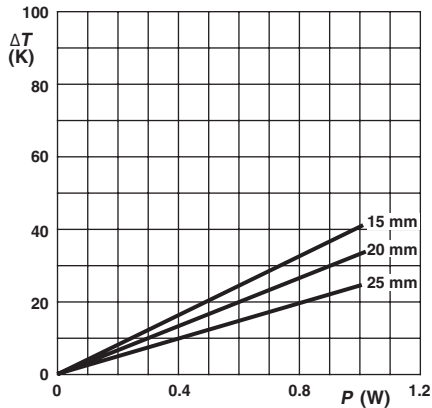

Ø 0.6 mm FeCu-leads

Minimum distance from resistor body to PCB = 1 mm

PR01 Temperature rise (ΔT) at the lead end (soldering point) as a function of dissipated power at various lead lengths after mounting.

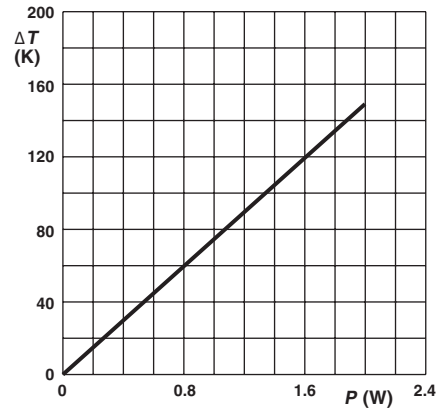

Ø 0.8 mm Cu-leads

PR02 Hot-spot temperature rise (ΔT) as a function of dissipated power.

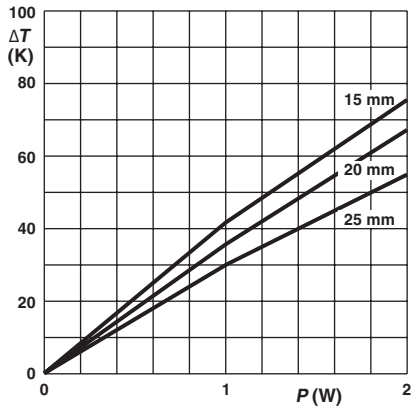

Ø 0.8 mm Cu-leads

Minimum distance from resistor body to PCB = 1 mm

PR02 Temperature rise (ΔT) at the lead end (soldering point) as a function of dissipated power at various lead lengths after mounting.

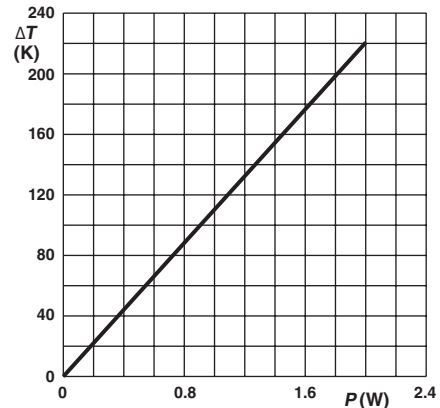

Ø 0.6 mm FeCu-leads

PR02 Hot-spot temperature rise (ΔT) as a function of dissipated power.

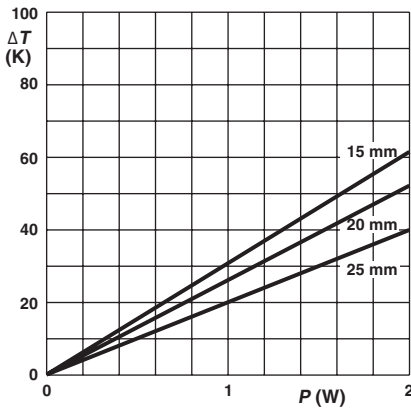

Ø 0.6 mm FeCu-leads

Minimum distance from resistor body to PCB = 1 mm

PR02 Temperature rise (ΔT) at the lead end (soldering point) as a function of dissipated power at various lead lengths after mounting.

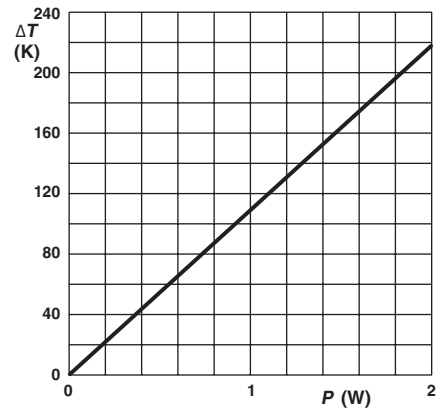

Ø 0.8 mm FeCu-leads

PR02 Hot-spot temperature rise (ΔT) as a function of dissipated power.

Application Information

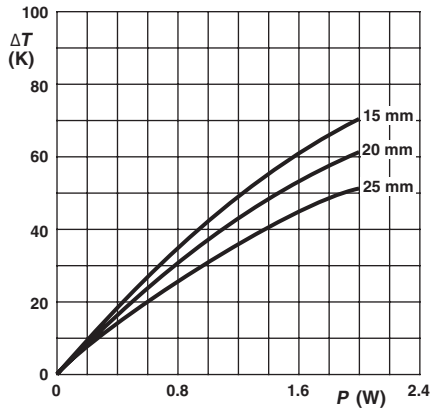

Ø 0.8 mm FeCu-leads
Minimum distance from resistor body to PCB = 1 mm

PR02 Temperature rise (ΔT) at the lead end (soldering point) as a function of dissipated power at various lead lengths after mounting.

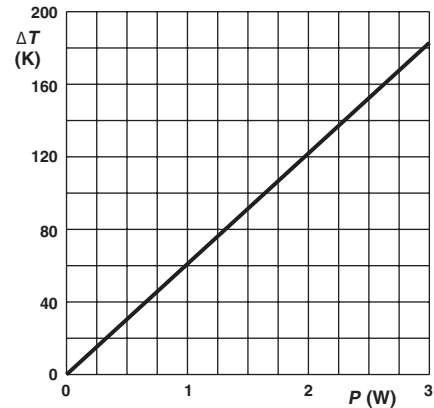

Ø 0.8 mm Cu-leads

PR03 Hot-spot temperature rise (ΔT) as a function of dissipated power.

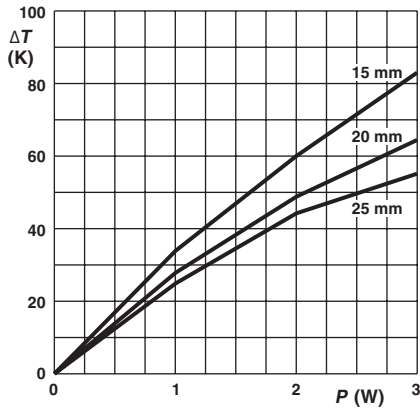

Ø 0.8 mm Cu-leads
Minimum distance from resistor body to PCB = 1 mm

PR03 Temperature rise (ΔT) at the lead end (soldering point) as a function of dissipated power at various lead lengths after mounting.

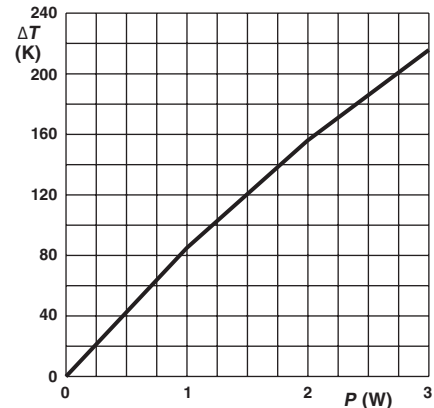

Ø 0.6 mm FeCu-leads

PR03 Hot-spot temperature rise (ΔT) as a function of dissipated power.

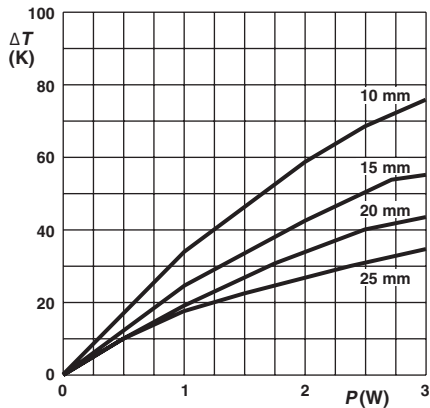

Ø 0.6 mm FeCu-leads
Minimum distance from resistor body to PCB = 1 mm

PR03 Temperature rise (ΔT) at the lead end (soldering point) as a function of dissipated power at various lead lengths after mounting.

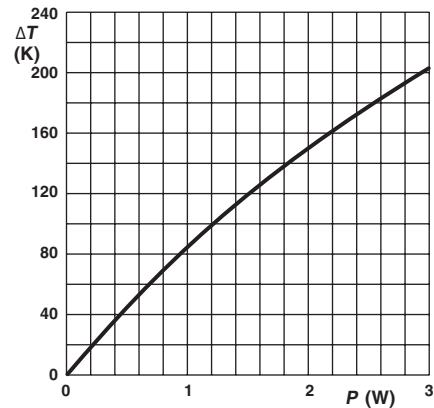

Ø 0.8 mm FeCu-leads

PR03 Hot-spot temperature rise (ΔT) as a function of dissipated power.

Application Information

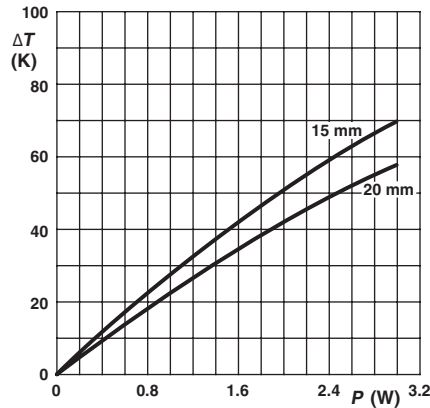

Ø 0.8 mm FeCu-leads
 Minimum distance from resistor body to PCB = 1 mm

PR03 Temperature rise (ΔT) at the lead end (soldering point) as a function of dissipated power at various lead lengths after mounting.

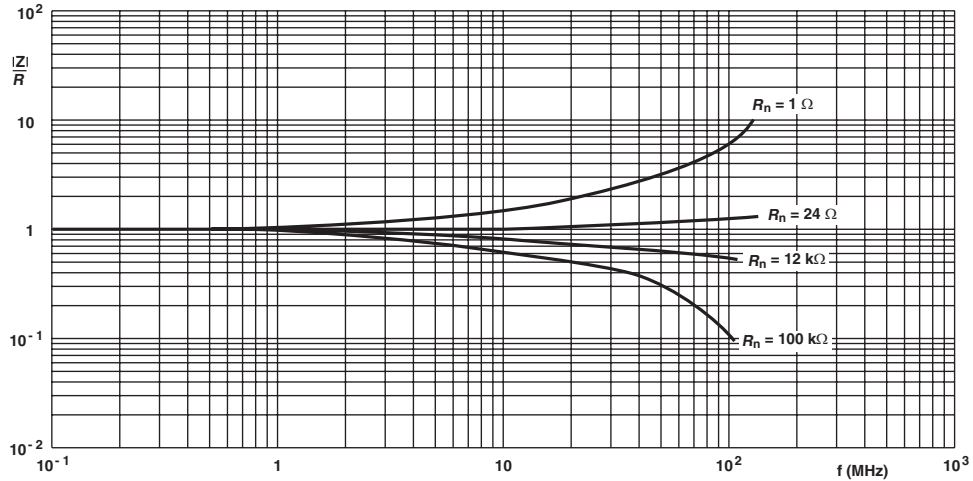

PR01 Impedance as a function of applied frequency

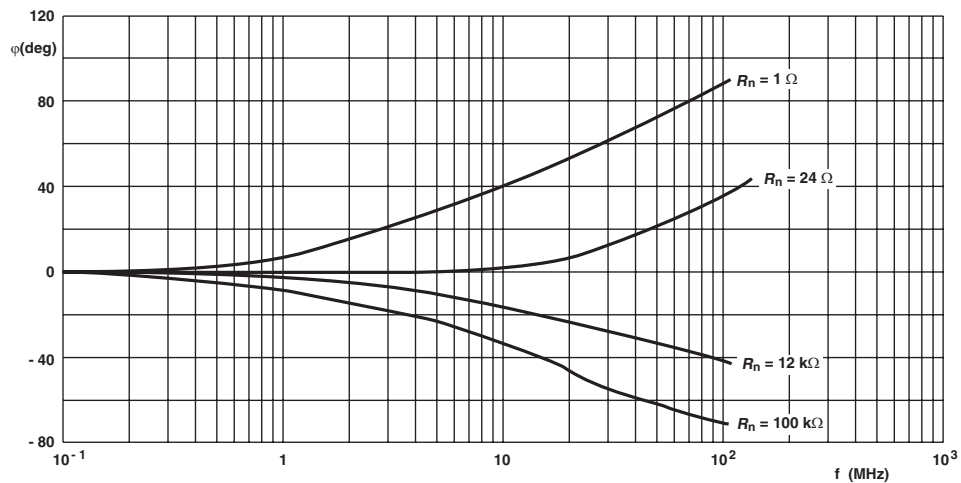

PR01 Phase angle as a function of applied frequency

Application Information

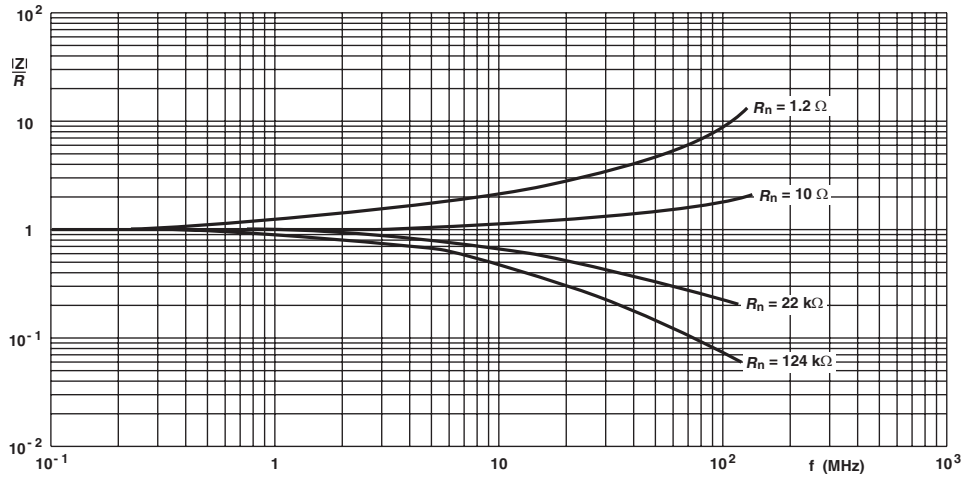

PR02 Impedance as a function of applied frequency

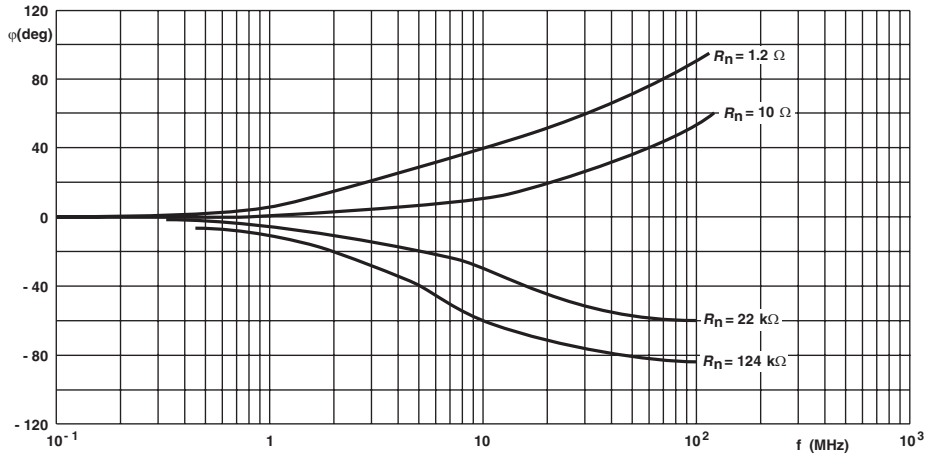

PR02 Phase angle as a function of applied frequency

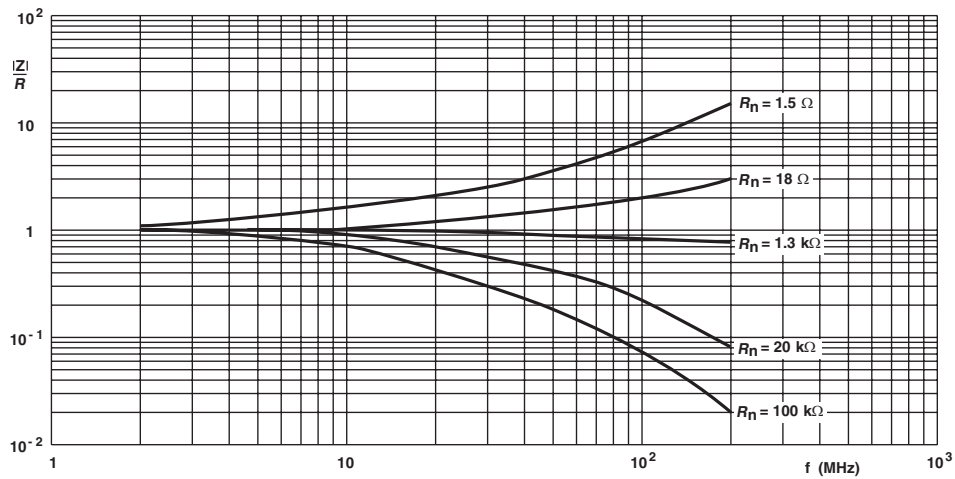

PR03 Impedance as a function of applied frequency

Application Information

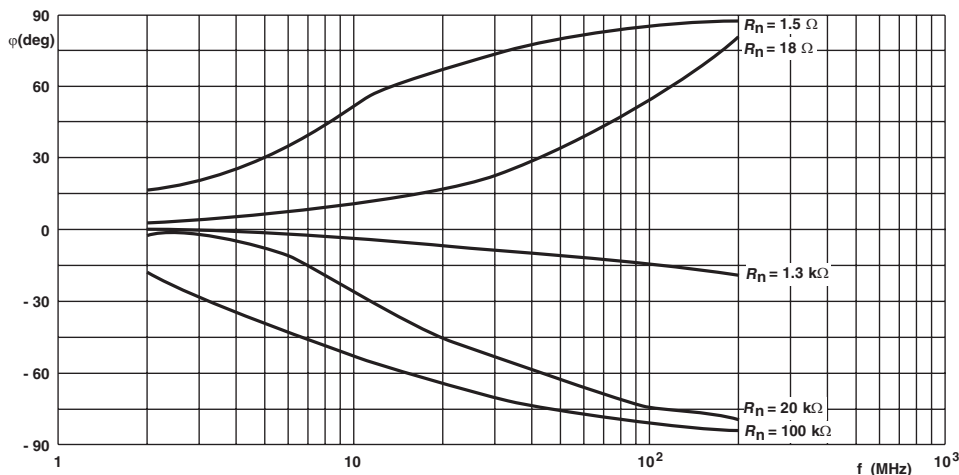

PR03 Phase angle as a function of applied frequency

Application Information

TESTS AND REQUIREMENTS

Essentially all tests are carried out in accordance with the schedule of "IEC publication 60115-1", category LCT/UCT/56 (rated temperature range: Lower Category Temperature, Upper Category Temperature; damp heat, long term, 56 days). The testing also covers the requirements specified by EIA and EIAJ.

The tests are carried out in accordance with IEC publication 60068-2, "Recommended basic climatic and mechanical robustness testing procedure for electronic components" and

under standard atmospheric conditions according to "IEC 60068-1", subclause 5.3.

In the Test Procedures and Requirements table, tests and requirements are listed with reference to the relevant clauses of "IEC publications 60115-1 and 60068-2"; a short description of the test procedure is also given. In some instances deviations from the IEC recommendations were necessary for our method of specifying.

All soldering tests are performed with mildly activated flux.

TEST PROCEDURES AND REQUIREMENTS				
IEC 60115-1 CLAUSE	IEC 60068-2 TEST METHOD	TEST	PROCEDURE	REQUIREMENTS
TESTS IN ACCORDANCE WITH THE SCHEDULE OF IEC PUBLICATION 60115-1				
4.4.1		visual examination		no holes; clean surface; no damage
4.4.2		dimensions (outline)	gauge (mm)	see Straight and Kinked Dimensions tables
4.5		resistance (refer note on first page for measuring distance)	applied voltage (+ 0/- 10 %): $R < 10 \Omega$: 0.1 V $10 \Omega \leq R < 100 \Omega$: 0.3 V $100 \Omega \leq R < 1 \text{ k}\Omega$: 1 V $1 \text{ k}\Omega \leq R < 10 \text{ k}\Omega$: 3 V $10 \text{ k}\Omega \leq R < 100 \text{ k}\Omega$: 10 V $100 \text{ k}\Omega \leq R < 1 \text{ M}\Omega$: 25 V $R = 1 \text{ M}\Omega$: 50 V	$R - R_{nom}$: max. $\pm 5 \%$
4.18	20 (Tb)	resistance to soldering heat	thermal shock: 3 s; 350 °C; 3 mm from body	ΔR max.: $\pm (1 \% R + 0.05 \Omega)$
4.29	45 (Xa)	component solvent resistance	isopropyl alcohol or H ₂ O followed by brushing in accordance with "MIL 202 F"	no visual damage
4.17	20 (Ta)	solderability	2 s; 235 °C	good tinning; no damage
4.7		voltage proof on insulation	maximum voltage 500 V _{RMS} during 1 min; metal block method	no breakdown or flashover

TEST PROCEDURES AND REQUIREMENTS				
IEC 60115-1 CLAUSE	IEC 60068-2 TEST METHOD	TEST	PROCEDURE	REQUIREMENTS
4.16 4.16.2 4.16.3 4.16.4	21 (U) 21 (Ua1) 21 (Ub) 21 (Uc)	robustness of terminations: tensile all samples bending half number of samples torsion other half of samples	load 10 N; 10 s load 5 N; 4 x 90° 3 x 360° in opposite directions	number of failures: $< 1 \times 10^{-6}$ number of failures: $< 1 \times 10^{-6}$ no damage ΔR max.: $\pm (0.5 \% R + 0.05 \Omega)$
4.20	29 (Eb)	bump	3 x 1500 bumps in three directions; 40 g	no damage ΔR max.: $\pm (0.5 \% R + 0.05 \Omega)$
4.22	6 (Fc)	vibration	frequency 10 to 500 Hz; displacement 1.5 mm or acceleration 10 g; three directions; total 6 h (3 x 2 h)	no damage ΔR max.: $\pm (0.5 \% R + 0.05 \Omega)$
4.19	14 (Na)	rapid change of temperature	30 min at LCT and 30 min at UCT; 5 cycles	no visual damage PR01: ΔR max.: $\pm (1 \% R + 0.05 \Omega)$ PR02: ΔR max.: $\pm (1 \% R + 0.05 \Omega)$ PR03: ΔR max.: $\pm (2 \% R + 0.05 \Omega)$
4.23 4.23.3 4.23.6	30 (Db) 30 (Db)	climatic sequence: damp heat (accelerated) 1 st cycle damp heat (accelerated) remaining cycles	6 days; 55 °C; 95 to 98 % RH	R_{ins} min.: $10^3 M\Omega$ ΔR max.: $\pm (3 \% R + 0.1 \Omega)$
4.24.2	3 (Ca)	damp heat (steady state) (IEC)	56 days; 40 °C; 90 to 95 % RH; loaded with 0.01 P _n (IEC steps: 4 to 100 V)	R_{ins} min.: 1000 MΩ ΔR max.: $\pm (3 \% R + 0.1 \Omega)$
4.25.1		endurance (at 70 °C)	1000 h; loaded with P _n or V _{max.} ; 1.5 h ON and 0.5 h OFF	ΔR max.: $\pm (5 \% R + 0.1 \Omega)$
4.8.4.2		temperature coefficient	at 20/LCT/20 °C and 20/UCT/20 °C (TC x 10 ⁻⁶ /K)	$\leq \pm 250$
OTHER TESTS IN ACCORDANCE WITH IEC 60115 CLAUSES AND IEC 60068 TEST METHOD				
4.17	20 (Tb)	solderability (after ageing)	8 h steam or 16 h 155 °C; leads immersed 6 mm for 2 ± 0.5 s in a solder bath at 235 ± 5 °C	good tinning ($\geq 95 \%$ covered); no damage
4.6.1.1		insulation resistance	maximum voltage (DC) after 1 min; metal block method	R_{ins} min.: $10^4 M\Omega$
see 2 nd amendment to IEC 60115-1, Jan. '87		pulse load		see Pulse Load Capabilities graphs



Disclaimer

All product specifications and data are subject to change without notice.

Vishay Intertechnology, Inc., its affiliates, agents, and employees, and all persons acting on its or their behalf (collectively, "Vishay"), disclaim any and all liability for any errors, inaccuracies or incompleteness contained herein or in any other disclosure relating to any product.

Vishay disclaims any and all liability arising out of the use or application of any product described herein or of any information provided herein to the maximum extent permitted by law. The product specifications do not expand or otherwise modify Vishay's terms and conditions of purchase, including but not limited to the warranty expressed therein, which apply to these products.

No license, express or implied, by estoppel or otherwise, to any intellectual property rights is granted by this document or by any conduct of Vishay.

The products shown herein are not designed for use in medical, life-saving, or life-sustaining applications unless otherwise expressly indicated. Customers using or selling Vishay products not expressly indicated for use in such applications do so entirely at their own risk and agree to fully indemnify Vishay for any damages arising or resulting from such use or sale. Please contact authorized Vishay personnel to obtain written terms and conditions regarding products designed for such applications.

Product names and markings noted herein may be trademarks of their respective owners.