

MC79M00 Series

500 mA Negative Voltage Regulators

The MC79M00 series of fixed output negative voltage regulators are intended as complements to the popular MC78M00 series devices.

Available in fixed output voltage options of -5.0 V , -8.0 V , -12 V and -15 V , these regulators employ current limiting, thermal shutdown, and safe-area compensation, making them remarkably rugged under most operating conditions. With adequate heatsinking they can deliver output currents in excess of 0.5 A .

Features

- No External Components Required
- Internal Thermal Overload Protection
- Internal Short Circuit Current Limiting
- Output Transistor Safe-Area Compensation
- Also Available in Surface Mount DPAK (DT) Package
- Pb-Free Packages are Available

DEVICE TYPE/NOMINAL OUTPUT VOLTAGE

Device	Nominal Output Voltage
MC79M05	-5.0 V
MC79M08	-8.0 V
MC79M12	-12 V
MC79M15	-15 V

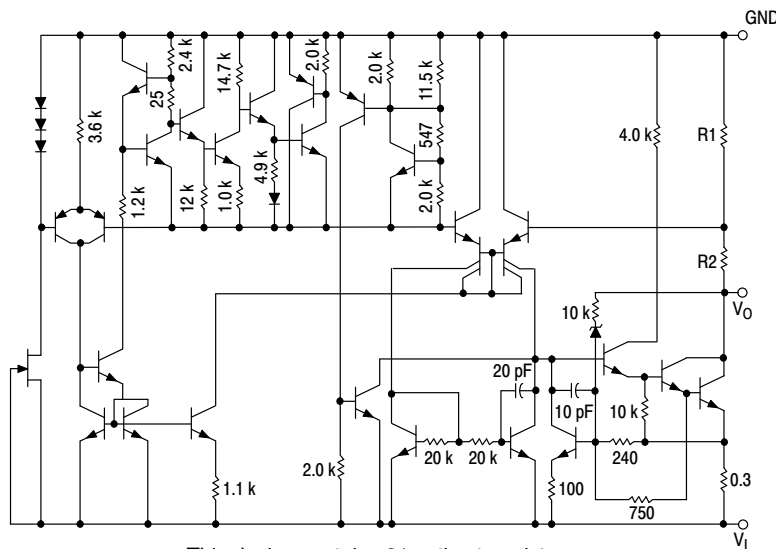

This device contains 31 active transistors.

Figure 1. Representative Schematic Diagram



ON Semiconductor®

<http://onsemi.com>

THREE-TERMINAL NEGATIVE FIXED VOLTAGE REGULATORS

STANDARD APPLICATION

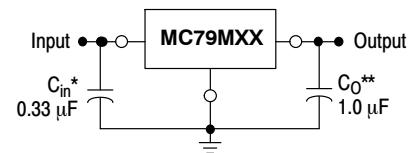

A common ground is required between the input and the output voltages. The input voltage must remain typically 1.1 V more negative even during the high point of the input ripple voltage.

XX These two digits of the type number indicate nominal voltage.

* C_{in} is required if regulator is located an appreciable distance from power supply filter.

** C_O improve stability and transient response.

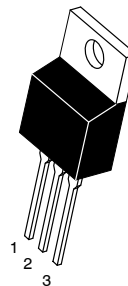

TO-220-3
T SUFFIX
CASE 221AB

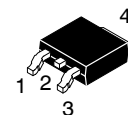

DPAK-3
DT SUFFIX
CASE 369C

MARKING DIAGRAMS

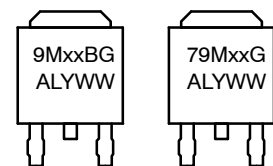
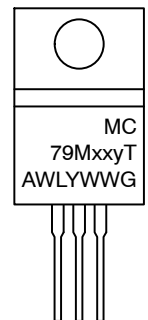

xx = 05, 08, 12, or 15
y = B or C
A = Assembly Location
WL, L = Wafer Lot
Y = Year
WW = Work Week
G = Pb-Free Device

ORDERING INFORMATION

See detailed ordering and shipping information in the package dimensions section on page 6 of this data sheet.

MC79M00 Series

MAXIMUM RATINGS ($T_A = 25^\circ\text{C}$, unless otherwise noted.)

Rating	Symbol	Value	Unit
Input Voltage	V_I	-35	Vdc
Power Dissipation			
Case 221A (TO-220-3)			
$T_A = 25^\circ\text{C}$	P_D	Internally Limited	W
Thermal Resistance, Junction-to-Ambient	θ_{JA}	65	$^\circ\text{C/W}$
Thermal Resistance, Junction-to-Case	θ_{JC}	5.0	$^\circ\text{C/W}$
Case 369C (DPAK-3)			
$T_A = 25^\circ\text{C}$	P_D	Internally Limited	W
Thermal Resistance, Junction-to-Ambient	θ_{JA}	92	$^\circ\text{C/W}$
Thermal Resistance, Junction-to-Case	θ_{JC}	6.0	$^\circ\text{C/W}$
Storage Junction Temperature	T_{stg}	-65 to +150	$^\circ\text{C}$
Operating Junction Temperature Range	T_J	-40 to +150	$^\circ\text{C}$

Stresses exceeding Maximum Ratings may damage the device. Maximum Ratings are stress ratings only. Functional operation above the Recommended Operating Conditions is not implied. Extended exposure to stresses above the Recommended Operating Conditions may affect device reliability.

*This device series contains ESD protection and exceeds the following tests:

- Human Body Model 2000 V per MIL_STD_883, Method 3015
- Machine Model Method 200 V

MC79M05B, C

ELECTRICAL CHARACTERISTICS ($V_I = -10\text{ V}$, $I_O = 350\text{ mA}$, T_{low} to T_{high} (Note 2), unless otherwise noted.)

Characteristic	Symbol	Min	Typ	Max	Unit
Output Voltage ($T_J = 25^\circ\text{C}$)	V_O	-4.8	-5.0	-5.2	Vdc
Line Regulation, $T_J = 25^\circ\text{C}$ (Note 1) -7.0 Vdc $\geq V_I \geq$ -25 Vdc -8.0 Vdc $\geq V_I \geq$ -18 Vdc	Reg_{line}	-	7.0 2.0	50 30	mV
Load Regulation, $T_J = 25^\circ\text{C}$ (Note 1) $5.0\text{ mA} \leq I_O \leq 500\text{ mA}$	Reg_{load}	-	30	100	mV
Output Voltage -7.0 Vdc $\geq V_I \geq$ -25 Vdc, $5.0\text{ mA} \leq I_O \leq 350\text{ mA}$	V_O	-4.75	-	-5.25	Vdc
Input Bias Current ($T_J = 25^\circ\text{C}$)	I_{IB}	-	4.3	8.0	mA
Input Bias Current Change -8.0 Vdc $\geq V_I \geq$ -25 Vdc, $I_O = 350\text{ mA}$ $5.0\text{ mA} \leq I_O \leq 350\text{ mA}$, $V_I = -10\text{ V}$	ΔI_{IB}	-	-	0.4 0.4	mA
Output Noise Voltage, $T_A = 25^\circ\text{C}$, $10\text{ Hz} \leq f \leq 100\text{ kHz}$	V_n	-	40	-	μV
Ripple Rejection ($f = 120\text{ Hz}$)	RR	54	66	-	dB
Dropout Voltage $I_O = 500\text{ mA}$, $T_J = 25^\circ\text{C}$	$V_I - V_O$	-	1.1	-	Vdc
Average Temperature Coefficient of Output Voltage $I_O = 5.0\text{ mA}$, $0^\circ\text{C} \leq T_J \leq 125^\circ\text{C}$	$\Delta V_O / \Delta T$	-	0.2	-	$\text{mV}/^\circ\text{C}$

1. Load and line regulation are specified at constant temperature. Change in V_O due to heating effects must be taken into account separately. Pulse testing with low duty cycle is used.
2. B = T_{low} to T_{high} , $-40^\circ\text{C} < T_J < 125^\circ\text{C}$ C = T_{low} to T_{high} , $0^\circ\text{C} < T_J < 125^\circ\text{C}$.

MC79M00 Series

MC79M08B, C

ELECTRICAL CHARACTERISTICS ($V_I = -10\text{ V}$, $I_O = 350\text{ mA}$, T_{low} to T_{high} (Note 4), unless otherwise noted.)

Characteristic	Symbol	Min	Typ	Max	Unit
Output Voltage ($T_J = 25^\circ\text{C}$)	V_O	-7.7	-8.0	-8.3	Vdc
Line Regulation, $T_J = 25^\circ\text{C}$ (Note 3) -10.5 Vdc $\geq V_I \geq$ -25 Vdc -11 Vdc $\geq V_I \geq$ -21 Vdc	Reg_{line}	-	5.0 3.0	80 50	mV
Load Regulation, $T_J = 25^\circ\text{C}$ (Note 3) $5.0\text{ mA} \leq I_O \leq 500\text{ mA}$	Reg_{load}	-	30	100	mV
Output Voltage -10.5 Vdc $\geq V_I \geq$ -25 Vdc, $5.0\text{ mA} \leq I_O \leq 350\text{ mA}$	V_O	-7.6	-8.0	-8.4	Vdc
Input Bias Current ($T_J = 25^\circ\text{C}$)	I_{IB}	-	-	8.0	mA
Input Bias Current Change -10.5 Vdc $\geq V_I \geq$ -25 Vdc, $I_O = 350\text{ mA}$ $5.0\text{ mA} \leq I_O \leq 350\text{ mA}$, $V_I = -10\text{ V}$	ΔI_{IB}	-	-	0.4 0.4	mA
Output Noise Voltage, $T_A = 25^\circ\text{C}$, $10\text{ Hz} \leq f \leq 100\text{ kHz}$	V_n	-	60	-	μV
Ripple Rejection ($f = 120\text{ Hz}$)	RR	54	63	-	dB
Dropout Voltage $I_O = 500\text{ mA}$, $T_J = 25^\circ\text{C}$	$V_I - V_O$	-	1.1	-	Vdc
Average Temperature Coefficient of Output Voltage $I_O = 5.0\text{ mA}$, $0^\circ\text{C} \leq T_J \leq 125^\circ\text{C}$	$\Delta V_O / \Delta T$	-	0.4	-	$\text{mV}/^\circ\text{C}$

3. Load and line regulation are specified at constant temperature. Change in V_O due to heating effects must be taken into account separately. Pulse testing with low duty cycle is used.
4. B = T_{low} to T_{high} , $-40^\circ\text{C} < T_J < 125^\circ\text{C}$
C = T_{low} to T_{high} , $0^\circ\text{C} < T_J < 125^\circ\text{C}$

MC79M12B, C

ELECTRICAL CHARACTERISTICS ($V_I = -19\text{ V}$, $I_O = 350\text{ mA}$, T_{low} to T_{high} (Note 6), unless otherwise noted.)

Characteristic	Symbol	Min	Typ	Max	Unit
Output Voltage ($T_J = 25^\circ\text{C}$)	V_O	-11.5	-12	-12.5	Vdc
Line Regulation, $T_J = 25^\circ\text{C}$ (Note 5) -14.5 Vdc $\geq V_I \geq$ -30 Vdc -15 Vdc $\geq V_I \geq$ -25 Vdc	Reg_{line}	-	5.0 3.0	80 50	mV
Load Regulation, $T_J = 25^\circ\text{C}$ (Note 5) $5.0\text{ mA} \leq I_O \leq 500\text{ mA}$	Reg_{load}	-	30	240	mV
Output Voltage -14.5 Vdc $\geq V_I \geq$ -30 Vdc, $5.0\text{ mA} \leq I_O \leq 350\text{ mA}$	V_O	-11.4	-	-12.6	Vdc
Input Bias Current ($T_J = 25^\circ\text{C}$)	I_{IB}	-	4.4	8.0	mA
Input Bias Current Change -14.5 Vdc $\geq V_I \geq$ -30 Vdc, $I_O = 350\text{ mA}$ $5.0\text{ mA} \leq I_O \leq 350\text{ mA}$, $V_I = -19\text{ V}$	ΔI_{IB}	-	-	0.4 0.4	mA
Output Noise Voltage, $T_A = 25^\circ\text{C}$, $10\text{ Hz} \leq f \leq 100\text{ kHz}$	V_n	-	75	-	μV
Ripple Rejection ($f = 120\text{ Hz}$)	RR	54	60	-	dB
Dropout Voltage $I_O = 500\text{ mA}$, $T_J = 25^\circ\text{C}$	$V_I - V_O$	-	1.1	-	Vdc
Average Temperature Coefficient of Output Voltage $I_O = 5.0\text{ mA}$, $0^\circ\text{C} \leq T_J \leq 125^\circ\text{C}$	$\Delta V_O / \Delta T$	-	-0.8	-	$\text{mV}/^\circ\text{C}$

5. Load and line regulation are specified at constant temperature. Change in V_O due to heating effects must be taken into account separately. Pulse testing with low duty cycle is used.
6. B = T_{low} to T_{high} , $-40^\circ\text{C} < T_J < 125^\circ\text{C}$
C = T_{low} to T_{high} , $0^\circ\text{C} < T_J < 125^\circ\text{C}$

MC79M00 Series

MC79M15B, C

ELECTRICAL CHARACTERISTICS ($V_I = -23\text{ V}$, $I_O = 350\text{ mA}$, T_{low} to T_{high} (Note 8), unless otherwise noted.)

Characteristic	Symbol	Min	Typ	Max	Unit
Output Voltage ($T_J = 25^\circ\text{C}$)	V_O	-14.4	-15	-15.6	Vdc
Line Regulation, $T_J = 25^\circ\text{C}$ (Note 7) -17.5 Vdc $\geq V_I \geq$ -30 Vdc -18 Vdc $\geq V_I \geq$ -28 Vdc	Reg_{line}	-	5.0 3.0	80 50	mV
Load Regulation, $T_J = 25^\circ\text{C}$ (Note 7) $5.0\text{ mA} \leq I_O \leq 500\text{ mA}$	Reg_{load}	-	30	240	mV
Output Voltage -17.5 Vdc $\geq V_I \geq$ -30 Vdc, $5.0\text{ mA} \leq I_O \leq 350\text{ mA}$	V_O	-14.25	-	-15.75	Vdc
Input Bias Current ($T_J = 25^\circ\text{C}$)	I_{IB}	-	4.4	8.0	mA
Input Bias Current Change -17.5 Vdc $\geq V_I \geq$ -30 Vdc, $I_O = 350\text{ mA}$ $5.0\text{ mA} \leq I_O \leq 350\text{ mA}$, $V_I = -23\text{ V}$	ΔI_{IB}	-	-	0.4 0.4	mA
Output Noise Voltage, $T_A = 25^\circ\text{C}$, $10\text{ Hz} \leq f \leq 100\text{ kHz}$	V_n	-	90	-	μV
Ripple Rejection ($f = 120\text{ Hz}$)	RR	54	60	-	dB
Dropout Voltage $I_O = 500\text{ mA}$, $T_J = 25^\circ\text{C}$	$V_I - V_O$	-	1.1	-	Vdc
Average Temperature Coefficient of Output Voltage $I_O = 5.0\text{ mA}$, $0^\circ\text{C} \leq T_J \leq 125^\circ\text{C}$	$\Delta V_O / \Delta T$	-	-1.0	-	$\text{mV}/^\circ\text{C}$

7. Load and line regulation are specified at constant temperature. Change in V_O due to heating effects must be taken into account separately. Pulse testing with low duty cycle is used.
8. B = T_{low} to T_{high} , $-40^\circ\text{C} < T_J < 125^\circ\text{C}$
C = T_{low} to T_{high} , $0^\circ\text{C} < T_J < 125^\circ\text{C}$

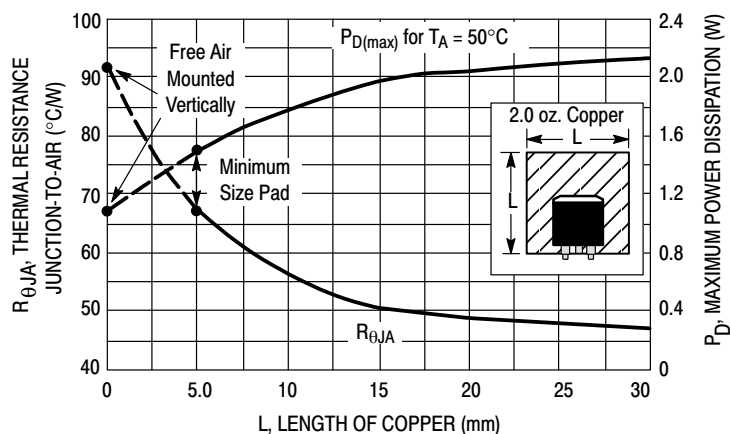

Figure 1. DPAK-3 Thermal Resistance and Maximum Power Dissipation versus P.C.B. Copper Length

MC79M00 Series

Protection Diodes

When external capacitors are used with MC79M00 series regulator it is sometimes necessary to add protection diodes to prevent the capacitors from discharging through low current points into the regulator or from output polarity reversals. Generally, no protection diode is required for values of output capacitance less than $10\mu\text{F}$. Figure 2 shows the MC79M15 with the recommended protection diodes.

- Opposite Polarity Protection

Diode D1 protects the regulator from output polarity reversals during startup, power off and short-circuit operation.

- Reverse-bias Protection

Diode D2 prevents output capacitor from discharging through the MC79M15 during an input short circuit or fast switch off of power supply.

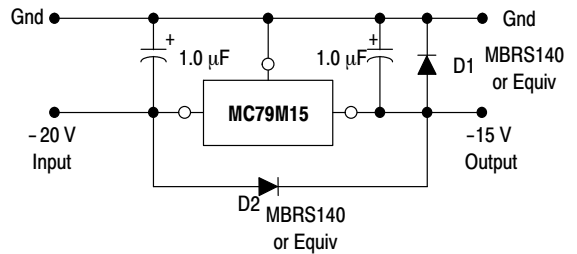

Figure 2. Protection Diodes

MC79M00 Series

ORDERING INFORMATION

Device	Output Voltage Tolerance	Operating Temperature Range	Package	Shipping [†]
MC79M05BDT	4.0%	$T_J = -40^{\circ}\text{C to } +125^{\circ}\text{C}$	DPAK	75 Units / Rail
MC79M05BDTG			DPAK (Pb-Free)	75 Units / Rail
MC79M05BDTRK			DPAK	2500 Units / Reel
MC79M05BDTRKG			DPAK (Pb-Free)	2500 Units / Reel
MC79M05BT			TO-220	50 Units / Rail
MC79M05BTG			TO-220 (Pb-Free)	50 Units / Rail
MC79M05CDT		$T_J = 0^{\circ}\text{C to } +125^{\circ}\text{C}$	DPAK	75 Units / Rail
MC79M05CDTG			DPAK (Pb-Free)	75 Units / Rail
MC79M05CDTRK			DPAK	2500 Units / Reel
MC79M05CDTRKG			DPAK (Pb-Free)	2500 Units / Reel
MC79M05CT			TO-220	50 Units / Rail
MC79M05CTG			TO-220 (Pb-Free)	50 Units / Rail
MC79M08BDT		$T_J = -40^{\circ}\text{C to } +125^{\circ}\text{C}$	DPAK	75 Units / Rail
MC79M08BDTRK			DPAK	2500 Units / Reel
MC79M08BDTRKG			DPAK (Pb-Free)	2500 Units / Reel
MC79M08BT			TO-220	50 Units / Rail
MC79M08BTG			TO-220 (Pb-Free)	50 Units / Rail
MC79M08CDT			$T_J = 0^{\circ}\text{C to } +125^{\circ}\text{C}$	DPAK
MC79M08CDTG		DPAK (Pb-Free)		75 Units / Rail
MC79M08CDTRK		DPAK		2500 Units / Reel
MC79M08CDTRKG		DPAK (Pb-Free)		2500 Units / Reel
MC79M08CT		TO-220		50 Units / Rail
MC79M08CTG		TO-220 (Pb-Free)		50 Units / Rail
MC79M12BDT		$T_J = -40^{\circ}\text{C to } +125^{\circ}\text{C}$	DPAK	75 Units / Rail
MC79M12BDTG			DPAK (Pb-Free)	75 Units / Rail
MC79M12BDTRK			DPAK	2500 Units / Reel
MC79M12BDTRKG			DPAK (Pb-Free)	2500 Units / Reel
MC79M12BT			TO-220	50 Units / Rail
MC79M12BTG			TO-220 (Pb-Free)	50 Units / Rail
MC79M12CDT		$T_J = 0^{\circ}\text{C to } +125^{\circ}\text{C}$	DPAK	75 Units / Rail
MC79M12CDTG	DPAK (Pb-Free)		75 Units / Rail	
MC79M12CDTRK	DPAK		2500 Units / Reel	
MC79M12CDTRKG	DPAK (Pb-Free)		2500 Units / Reel	
MC79M12CT	TO-220		50 Units / Rail	
MC79M12CTG	TO-220 (Pb-Free)		50 Units / Rail	

[†]For information on tape and reel specifications, including part orientation and tape sizes, please refer to our Tape and Reel Packaging Specifications Brochure, BRD8011/D.

MC79M00 Series

ORDERING INFORMATION

Device	Output Voltage Tolerance	Operating Temperature Range	Package	Shipping†
MC79M15BDT	4.0%	$T_J = -40^{\circ}\text{C to } +125^{\circ}\text{C}$	DPAK	75 Units / Rail
MC79M15BDTG			DPAK (Pb-Free)	75 Units / Rail
MC79M15BDTRK			DPAK	2500 Units / Reel
MC79M15BDTRKG			DPAK (Pb-Free)	2500 Units / Reel
MC79M15BT			TO-220	50 Units / Rail
MC79M15BTG			TO-220 (Pb-Free)	50 Units / Rail
MC79M15CDT		$T_J = 0^{\circ}\text{C to } +125^{\circ}\text{C}$	DPAK	75 Units / Rail
MC79M15CDTG			DPAK (Pb-Free)	75 Units / Rail
MC79M15CDTRK			DPAK	2500 Units / Reel
MC79M15CDTRKG			DPAK (Pb-Free)	2500 Units / Reel
MC79M15CT			TO-220	50 Units / Rail
MC79M15CTG			TO-220 (Pb-Free)	50 Units / Rail

†For information on tape and reel specifications, including part orientation and tape sizes, please refer to our Tape and Reel Packaging Specifications Brochure, BRD8011/D.

MECHANICAL CASE OUTLINE

PACKAGE DIMENSIONS

ON Semiconductor®



TO-220, SINGLE GAUGE CASE 221AB-01 ISSUE A

DATE 16 NOV 2010

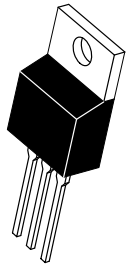

SCALE 1:1

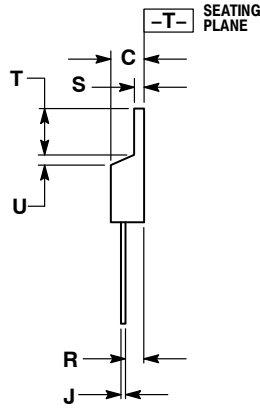
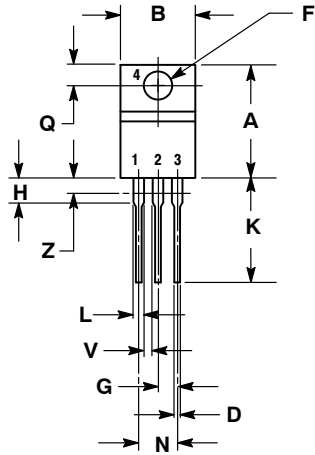

NOTES:

1. DIMENSIONING AND TOLERANCING PER ANSI Y14.5M, 1982.
2. CONTROLLING DIMENSION: INCHES.
3. DIMENSION Z DEFINES A ZONE WHERE ALL BODY AND LEAD IRREGULARITIES ARE ALLOWED.
4. PRODUCT SHIPPED PRIOR TO 2008 HAD DIMENSIONS S = 0.045 - 0.055 INCHES (1.143 - 1.397 MM)

DIM	INCHES		MILLIMETERS	
	MIN	MAX	MIN	MAX
A	0.570	0.620	14.48	15.75
B	0.380	0.405	9.66	10.28
C	0.160	0.190	4.07	4.82
D	0.025	0.035	0.64	0.88
F	0.142	0.147	3.61	3.73
G	0.095	0.105	2.42	2.66
H	0.110	0.155	2.80	3.93
J	0.018	0.025	0.46	0.64
K	0.500	0.562	12.70	14.27
L	0.045	0.060	1.15	1.52
N	0.190	0.210	4.83	5.33
Q	0.100	0.120	2.54	3.04
R	0.080	0.110	2.04	2.79
S	0.020	0.024	0.508	0.61
T	0.235	0.255	5.97	6.47
U	0.000	0.050	0.00	1.27
V	0.045	---	1.15	---
Z	---	0.080	---	2.04

STYLE 1:

- PIN 1. BASE
- 2. COLLECTOR
- 3. EMITTER
- 4. COLLECTOR

STYLE 2:

- PIN 1. BASE
- 2. EMITTER
- 3. COLLECTOR
- 4. EMITTER

STYLE 3:

- PIN 1. CATHODE
- 2. ANODE
- 3. GATE
- 4. ANODE

STYLE 4:

- PIN 1. MAIN TERMINAL 1
- 2. MAIN TERMINAL 2
- 3. GATE
- 4. MAIN TERMINAL 2

STYLE 5:

- PIN 1. GATE
- 2. DRAIN
- 3. SOURCE
- 4. DRAIN

STYLE 6:

- PIN 1. ANODE
- 2. CATHODE
- 3. ANODE
- 4. CATHODE

STYLE 7:

- PIN 1. CATHODE
- 2. ANODE
- 3. CATHODE
- 4. ANODE

STYLE 8:

- PIN 1. CATHODE
- 2. ANODE
- 3. EXTERNAL TRIP/DELAY
- 4. ANODE

STYLE 9:

- PIN 1. GATE
- 2. COLLECTOR
- 3. EMITTER
- 4. COLLECTOR

STYLE 10:

- PIN 1. GATE
- 2. SOURCE
- 3. DRAIN
- 4. SOURCE

STYLE 11:

- PIN 1. DRAIN
- 2. SOURCE
- 3. GATE
- 4. SOURCE

DOCUMENT NUMBER:	98AON23085D	Electronic versions are uncontrolled except when accessed directly from the Document Repository. Printed versions are uncontrolled except when stamped "CONTROLLED COPY" in red.
DESCRIPTION:	TO-220, SINGLE GAUGE	PAGE 1 OF 1

ON Semiconductor and are trademarks of Semiconductor Components Industries, LLC dba ON Semiconductor or its subsidiaries in the United States and/or other countries. ON Semiconductor reserves the right to make changes without further notice to any products herein. ON Semiconductor makes no warranty, representation or guarantee regarding the suitability of its products for any particular purpose, nor does ON Semiconductor assume any liability arising out of the application or use of any product or circuit, and specifically disclaims any and all liability, including without limitation special, consequential or incidental damages. ON Semiconductor does not convey any license under its patent rights nor the rights of others.

MECHANICAL CASE OUTLINE

PACKAGE DIMENSIONS

ON Semiconductor®

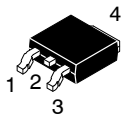

SCALE 1:1

DPAK (SINGLE GAUGE) CASE 369C ISSUE F

DATE 21 JUL 2015



NOTES:

1. DIMENSIONING AND TOLERANCING PER ASME Y14.5M, 1994.
2. CONTROLLING DIMENSION: INCHES.
3. THERMAL PAD CONTOUR OPTIONAL WITHIN DIMENSIONS b3, L3 and Z.
4. DIMENSIONS D AND E DO NOT INCLUDE MOLD FLASH, PROTRUSIONS, OR BURRS. MOLD FLASH, PROTRUSIONS, OR GATE BURRS SHALL NOT EXCEED 0.006 INCHES PER SIDE.
5. DIMENSIONS D AND E ARE DETERMINED AT THE OUTERMOST EXTREMES OF THE PLASTIC BODY.
6. DATUMS A AND B ARE DETERMINED AT DATUM PLANE H.
7. OPTIONAL MOLD FEATURE.

DIM	INCHES		MILLIMETERS	
	MIN	MAX	MIN	MAX
A	0.086	0.094	2.18	2.38
A1	0.000	0.005	0.00	0.13
b	0.025	0.035	0.63	0.89
b2	0.028	0.045	0.72	1.14
b3	0.180	0.215	4.57	5.46
c	0.018	0.024	0.46	0.61
c2	0.018	0.024	0.46	0.61
D	0.235	0.245	5.97	6.22
E	0.250	0.265	6.35	6.73
e	0.090 BSC		2.29 BSC	
H	0.370	0.410	9.40	10.41
L	0.055	0.070	1.40	1.78
L1	0.114 REF		2.90 REF	
L2	0.020 BSC		0.51 BSC	
L3	0.035	0.050	0.89	1.27
L4	---	0.040	---	1.01
Z	0.155	---	3.93	---

GENERIC MARKING DIAGRAM*

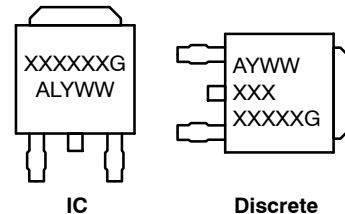

- XXXXXX = Device Code
- A = Assembly Location
- L = Wafer Lot
- Y = Year
- WW = Work Week
- G = Pb-Free Package

*This information is generic. Please refer to device data sheet for actual part marking.

- | | | | | |
|--|--|---|---|--|
| <p>STYLE 1:
PIN 1. BASE
2. COLLECTOR
3. EMITTER
4. COLLECTOR</p> | <p>STYLE 2:
PIN 1. GATE
2. DRAIN
3. SOURCE
4. DRAIN</p> | <p>STYLE 3:
PIN 1. ANODE
2. CATHODE
3. ANODE
4. CATHODE</p> | <p>STYLE 4:
PIN 1. CATHODE
2. ANODE
3. GATE
4. ANODE</p> | <p>STYLE 5:
PIN 1. GATE
2. ANODE
3. CATHODE
4. ANODE</p> |
| <p>STYLE 6:
PIN 1. MT1
2. MT2
3. GATE
4. MT2</p> | <p>STYLE 7:
PIN 1. GATE
2. COLLECTOR
3. EMITTER
4. COLLECTOR</p> | <p>STYLE 8:
PIN 1. N/C
2. CATHODE
3. ANODE
4. CATHODE</p> | <p>STYLE 9:
PIN 1. ANODE
2. CATHODE
3. RESISTOR ADJUST
4. CATHODE</p> | <p>STYLE 10:
PIN 1. CATHODE
2. ANODE
3. CATHODE
4. ANODE</p> |

SOLDERING FOOTPRINT*

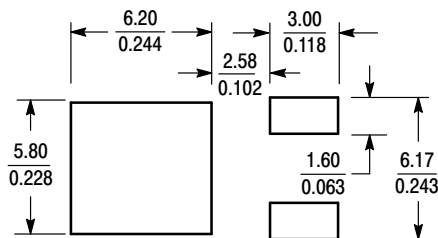

SCALE 3:1 (mm / inches)

*For additional information on our Pb-Free strategy and soldering details, please download the ON Semiconductor Soldering and Mounting Techniques Reference Manual, SOLDERRM/D.

DOCUMENT NUMBER:	98AON10527D	Electronic versions are uncontrolled except when accessed directly from the Document Repository. Printed versions are uncontrolled except when stamped "CONTROLLED COPY" in red.
DESCRIPTION:	DPAK (SINGLE GAUGE)	PAGE 1 OF 1

ON Semiconductor and ON are trademarks of Semiconductor Components Industries, LLC dba ON Semiconductor or its subsidiaries in the United States and/or other countries. ON Semiconductor reserves the right to make changes without further notice to any products herein. ON Semiconductor makes no warranty, representation or guarantee regarding the suitability of its products for any particular purpose, nor does ON Semiconductor assume any liability arising out of the application or use of any product or circuit, and specifically disclaims any and all liability, including without limitation special, consequential or incidental damages. ON Semiconductor does not convey any license under its patent rights nor the rights of others.

onsemi, **Onsemi**, and other names, marks, and brands are registered and/or common law trademarks of Semiconductor Components Industries, LLC dba "**onsemi**" or its affiliates and/or subsidiaries in the United States and/or other countries. **onsemi** owns the rights to a number of patents, trademarks, copyrights, trade secrets, and other intellectual property. A listing of **onsemi**'s product/patent coverage may be accessed at www.onsemi.com/site/pdf/Patent-Marking.pdf. **onsemi** reserves the right to make changes at any time to any products or information herein, without notice. The information herein is provided "as-is" and **onsemi** makes no warranty, representation or guarantee regarding the accuracy of the information, product features, availability, functionality, or suitability of its products for any particular purpose, nor does **onsemi** assume any liability arising out of the application or use of any product or circuit, and specifically disclaims any and all liability, including without limitation special, consequential or incidental damages. Buyer is responsible for its products and applications using **onsemi** products, including compliance with all laws, regulations and safety requirements or standards, regardless of any support or applications information provided by **onsemi**. "Typical" parameters which may be provided in **onsemi** data sheets and/or specifications can and do vary in different applications and actual performance may vary over time. All operating parameters, including "Typicals" must be validated for each customer application by customer's technical experts. **onsemi** does not convey any license under any of its intellectual property rights nor the rights of others. **onsemi** products are not designed, intended, or authorized for use as a critical component in life support systems or any FDA Class 3 medical devices or medical devices with a same or similar classification in a foreign jurisdiction or any devices intended for implantation in the human body. Should Buyer purchase or use **onsemi** products for any such unintended or unauthorized application, Buyer shall indemnify and hold **onsemi** and its officers, employees, subsidiaries, affiliates, and distributors harmless against all claims, costs, damages, and expenses, and reasonable attorney fees arising out of, directly or indirectly, any claim of personal injury or death associated with such unintended or unauthorized use, even if such claim alleges that **onsemi** was negligent regarding the design or manufacture of the part. **onsemi** is an Equal Opportunity/Affirmative Action Employer. This literature is subject to all applicable copyright laws and is not for resale in any manner.

PUBLICATION ORDERING INFORMATION

LITERATURE FULFILLMENT:

Email Requests to: orderlit@onsemi.com

onsemi Website: www.onsemi.com

TECHNICAL SUPPORT

North American Technical Support:

Voice Mail: 1 800-282-9855 Toll Free USA/Canada

Phone: 011 421 33 790 2910

Europe, Middle East and Africa Technical Support:

Phone: 00421 33 790 2910

For additional information, please contact your local Sales Representative