



LEDTECH ELECTRONICS CORP.

..... NANYA ROAD,MUGANG ZHAOQING
..... CITY GUANGDONG CHINA.

..... TEL:86-758-2875541,2870651,2877464,2876185,2877017

..... FAX:86-758-2878014

..... *Http://www.ledtech.com.tw*

SPECIFICATION

PART NO. : LT7T21E-41

1.9×2.9MM RECTANGULAR LED LAMP

Approved by	Checked by	Prepared by
<i>Jack</i>	<i>Jang</i>	<i>Bao Min</i>



1.9×2.9MM RECTANGULAR LED LAMP

PART NO. : LT7T21E-41

Features

- * High intensity
- * Reliable and rugged
- * Low current requirement
- * IC compatible

Description

The Green lamp are made with GaP/GaP chip and Green diffused epoxy resin.

Package Dimensions

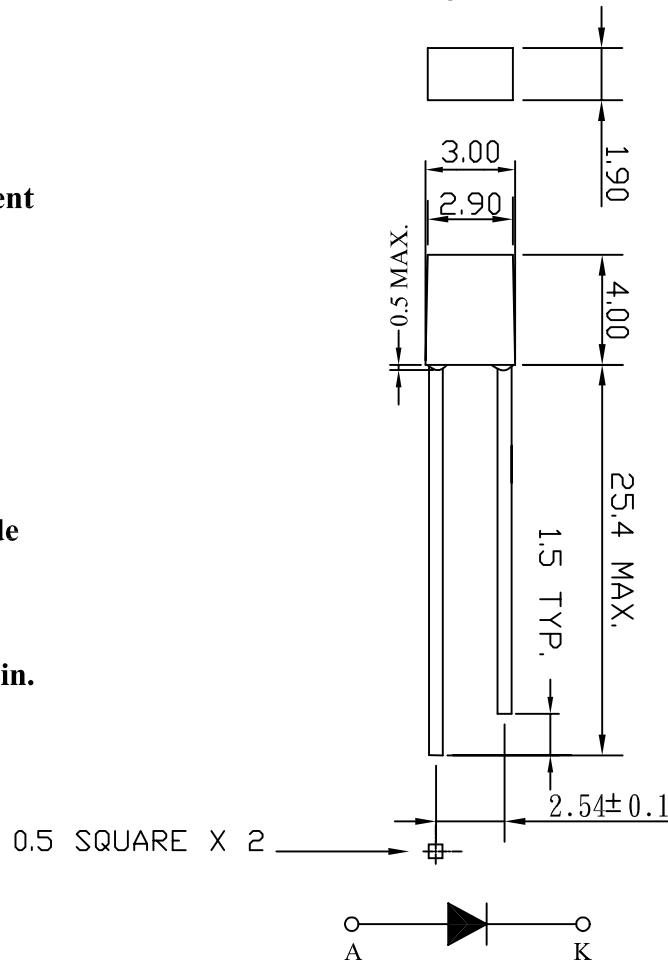

Notes:

- 1.All dimensions are in millimeters.
- 2.Tolerance is ± 0.25 mm unless otherwise noted.

Part No.	Led Chip		Lens Color
	Material	Emitting Color	
LT7T21E-41	GaP/GaP	Green	Green diffused



1.9×2.9MM RECTANGULAR LED LAMP
PART NO. : LT7T21E-41

Page : 2/5

Absolute Maximum Ratings at Ta=25°C :

Parameter	Symbol	Rating	Unit
Power Dissipation	Pd	78	mW
Reverse Voltage	Vr	5	V
D.C. Forward Current	If	30	mA
Peak Current (1/10 Duty Cycle , 0.1 ms Pulse Width)	If(Peak)	100	mA
Operating Temperature Range	Topr	-25 to +85	°C
Storage Temperature Range	Tstg	-40 to +100	°C
Lead Soldering Temp.(1.6mm from body) for 5 seconds		260	°C

Electrical and Optical Characteristics :

Parameter	Symbol	Condition	Min.	Typ.	Max.	Unit
Luminous Intensity	Iv	If=2mA	9.0	15.0		mcd
Forward Voltage	Vf	If=20mA		2.1	2.6	V
Peak Wavelength	λP	If=20mA		567		nm
Dominant Wavelength	λD	If=20mA		572		nm
Reverse Current	Ir	Vr=5V			100	μA
Viewing Angle	$2\theta 1/2$	If=20mA		110		deg
Spectrum Line Halfwidth	$\Delta \lambda$	If=20mA		30		nm



**1.9×2.9MM RECTANGULAR LED LAMP
PART NO. : LT7T21E-41**

Typical Electrical / Optical Characteristics Curves :

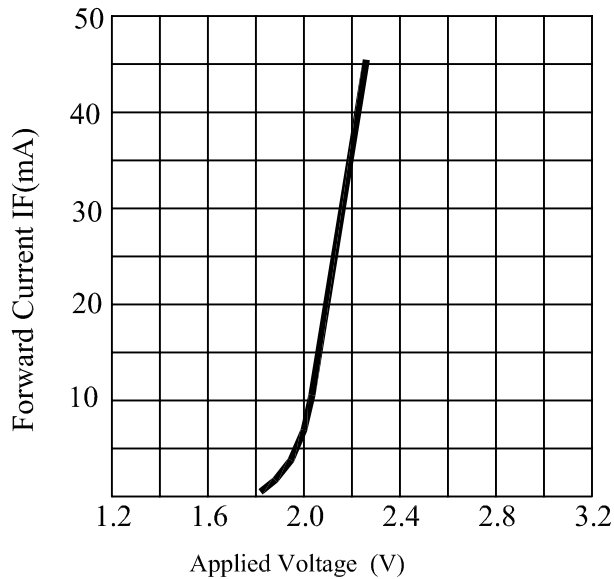

FORWARD CURRENT VS. APPLIED VOLTAGE

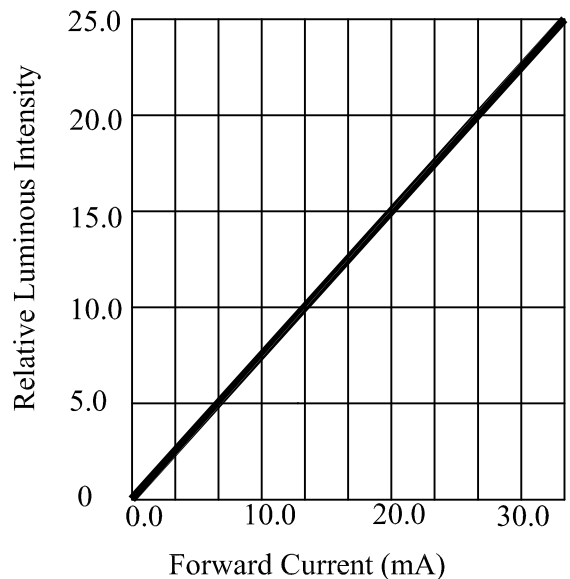

FORWARD CURRENT VS. LUMINOUS INTENSITY

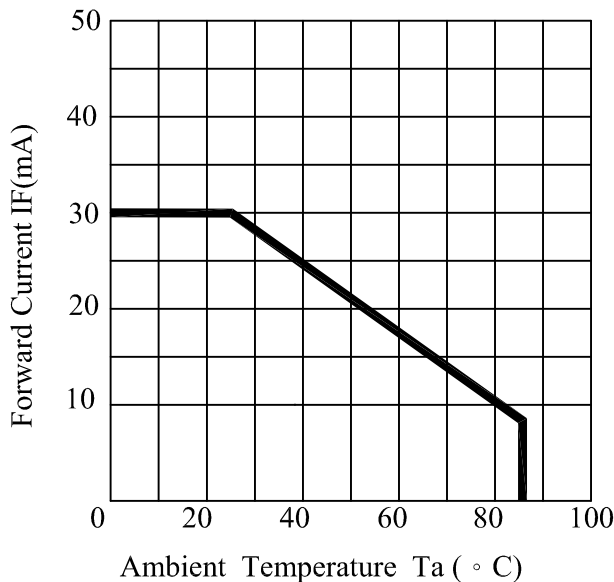

AMBIENT TEMPERATURE VS. FORWARD CURRENT

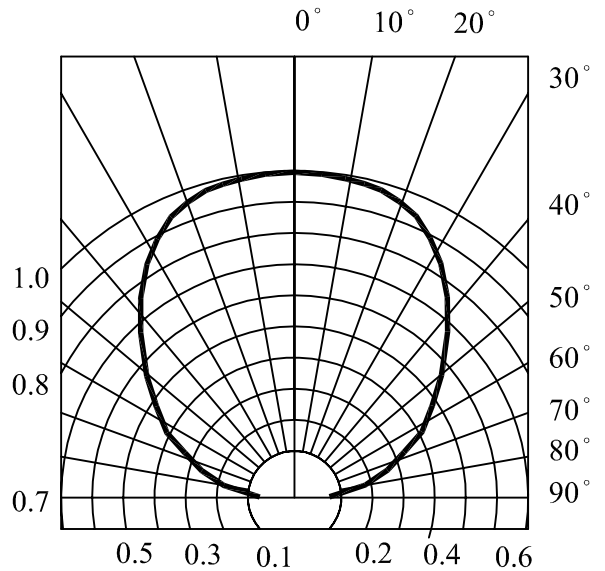

RADIATION DIAGRAM



1.9×2.9MM RECTANGULAR LED LAMP

PART NO. : LT7T21E-41

Page : 4/5

Reliability Test Method :

Test Item	Test Condition	Duration Time
Operation Life	If=20mA / Ta=25°C	168hrs
Storage at High Temperature	Ta=100°C	168hrs
Storage at Low Temperature	Ta=-40°C	168hrs
Storage at High Temperature/High Humidity	Ta=85°C /RH=85%	168hrs
Operating at High Temperature	Ta=85°C / If=20mA	168hrs
Operating at Low Temperature	Ta=-25°C / If=20mA	168hrs
Thermal Shock	Ta/T=100°C/30min~ -40°C/30min	10 cycles
Solderability	Tsol=230°C	5 sec

Criteria for Judging The Damage:

Item	Symbol	Test Condition	Criteria for Judgment	
			Min.	Max.
Forward Voltage	Vf	If=20mA	-----	Initial Data x1.1
Reverse Current	Ir	Vr=5V	-----	100 μA
Luminous Intensity	Iv	If=20mA	Initial Data x0.8	-----



1.9×2.9MM RECTANGULAR LED LAMP

PART NO. : LT7T21E-41

ENCASED TYPE

PLASTIC PACKAGE
 QUANTITY: 1,000 PCS

LEDTECH ELECTRONICS CORP.	
PART NO :LTXXXX-XX	
Q'TY	: PCS
LOT NO	:XXXXXXXXXX
DATE	:
BIN CODE:	

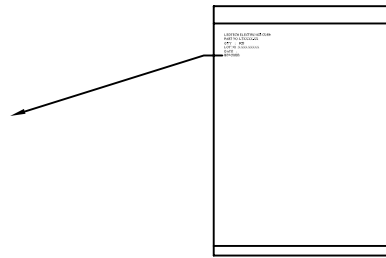

INNER BOX
 QUANTITY: 20 PACKETS
 TOTAL: 20,000 PCS

PART NO.	LXXXX-XX-XX				
LOT NO.	XXXXXXXXXX				
BIN CODE	Xx X	Xx X	Xx X	Xx X	TOTAL
QUANTITY	PCS	PCS	PCS	PCS	PCS
DATE	XXXX, XX, XX				

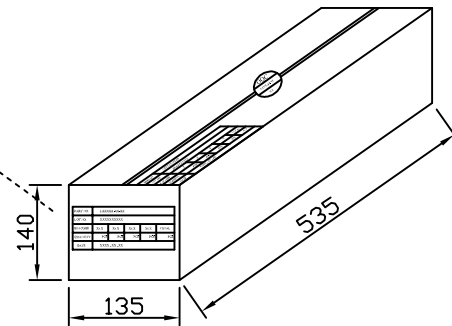

OUTER CARTON
 QUANTITY: 4 BOX
 TOTAL: 80,000 PCS

C/T NO. 箱 號	XX
PART NO. 料 號	LXXXX-XX-XX
QUANTITY 數 量	PCS
N.W. 淨 重	KGS
G.W. 毛 重	KGS
REMARK 備 註	

