

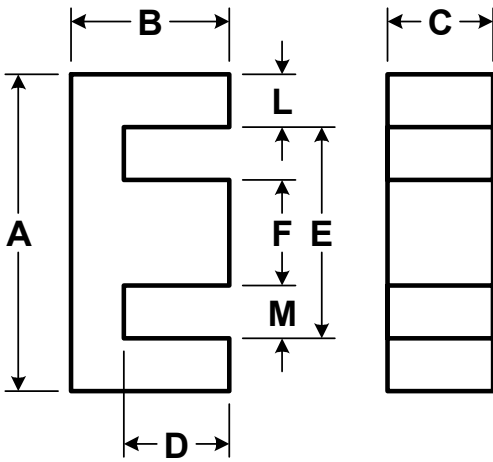

**00K1808E040**

110 Delta Drive  
 Pittsburgh, PA 15238  
 Phone: 412/696-1333  
 Fax: 412/696-0333  
 Email: magnetics@spang.com



DIMENSIONS (mm)							
A	B	C	D(min.)	E(min.)	F	L(nom.)	M(min.)
19.30	8.10	4.78	5.54	13.90	4.78	2.39	4.65

PHYSICAL CHARACTERISTICS		
$l_e$ (mm) Path Length	$A_e$ (mm <sup>2</sup> ) Cross Section	$V_e$ (mm <sup>3</sup> ) Volume
40.1	22.8	914.0

$A_L \pm 8\%$     35