



**Photocoupler**  
**Product Data Sheet**  
**LTV-352T**

Spec No. :DS70-2001-002  
Effective Date: 08/12/2017  
Revision: L

**LITE-ON DCC**

**RELEASE**

**BNS-OD-FC001/A4**

## Photocoupler LTV-352T series

### 1. DESCRIPTION

#### 1.1 Features

- Current transfer ratio ( CTR : MIN. 1000% at  $I_F = 1\text{mA}$ ,  $V_{CE} = 2\text{V}$  )
- High input-output isolation voltage (  $V_{iso} = 3,750\text{Vrms}$  )
- High collector-emitter voltage (  $V_{CEO} = 300\text{V}$  )
- Mini-flat package : 2.0mm profile : LTV-352T
- SOP-4 package
- Safety approval
  - UL 1577 & cUL
  - VDE DIN EN60747-5-5 (VDE 0884-5) ,
  - CSA CA5A
  - FIMKO/DEMKO/SEMKO/NEMKO
- RoHS Compliance
  - All materials be used in device are followed EU RoHS directive (No.2002/95/EC).
- ESD pass HBM 8000V/ MM2000V/ CDM2000V
- MSL class1

#### 1.2 Applications

- Hybrid substrates that require high density mounting.
- Programmable controllers

## Photocoupler LTV-352T series

### 2. PACKAGE DIMENSIONS

#### 2.1 LTV-352T series

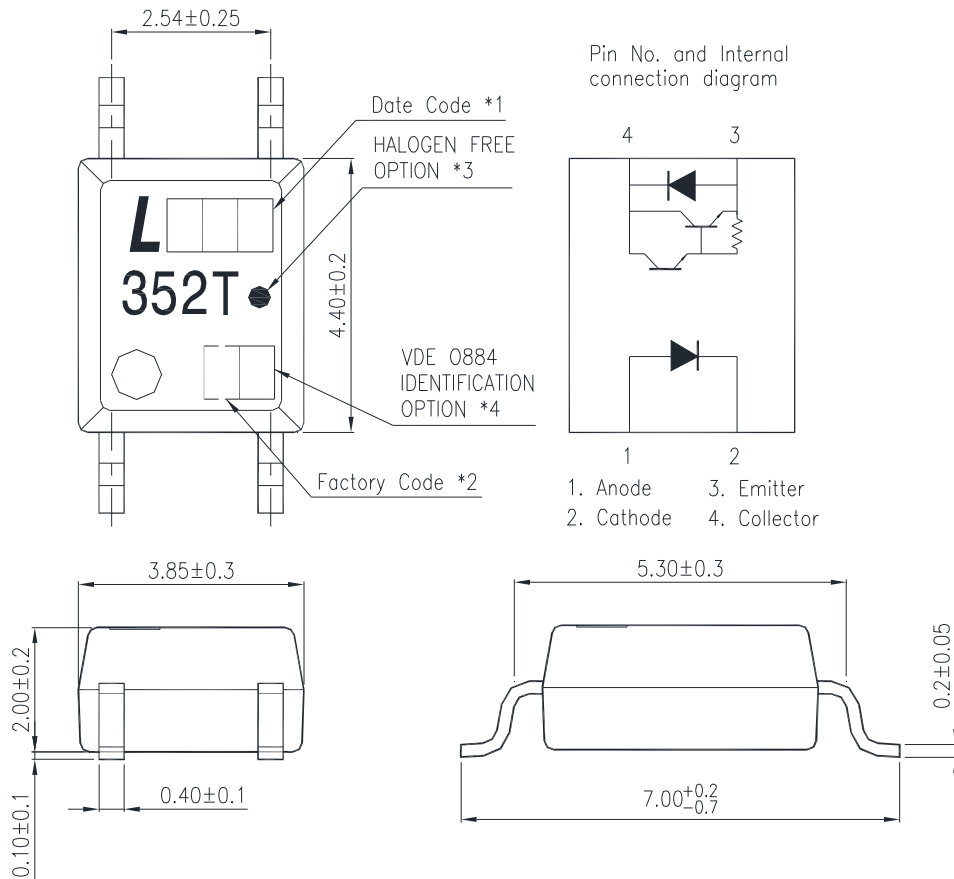

#### Notes :

- 1-digit year code, Example : 2010 = A  
2-digit work week ranging from '01' to '53'
- Factory identification mark shall be marked (W: China -CZ, X: China -TJ)
- “●” indicates halogen free option.
- “4” or “V” for VDE option.

\*All dimensions in millimeters.

## Photocoupler LTV-352T series

### 3. TAPING DIMENSIONS

#### 3.1 LTV-352T-TP

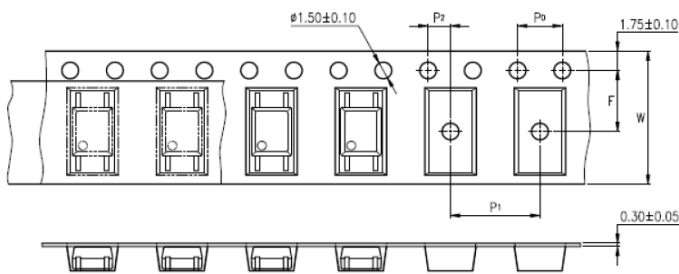

#### 3.2 LTV-352T

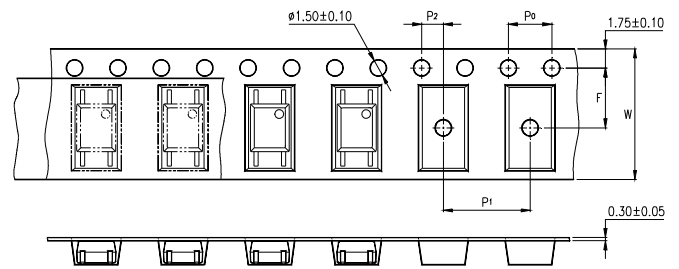

Description	Symbol	Dimension in mm (inch)
Tape wide	W	12±0.3 (0.472)
Pitch of sprocket holes	P <sub>0</sub>	4±0.1 (0.157)
Distance of compartment	F	5.5±0.1 (0.217)
	P <sub>2</sub>	2±0.1 (0.079)
Distance of compartment to compartment	P <sub>1</sub>	8±0.1 (0.315)

#### 3.3 Quantities Per Reel

Package Type	LTV-352T series
Quantities (pcs)	3000

## Photocoupler LTV-352T series

### 4. RATING AND CHARACTERISTICS

#### 4.1 Absolute Maximum Ratings at Ta=25°C

	Parameter	Symbol	Rating	Unit
Input	Forward Current	$I_F$	50	mA
	Reverse Voltage	$V_R$	6	V
	Power Dissipation	$P$	70	mW
	Junction Temperature	$T_J$	125	°C
Output	Collector - Emitter Voltage	$V_{CEO}$	300	V
	Emitter - Collector Voltage	$V_{ECO}$	0.1	V
	Collector Current	$I_C$	150	mA
	Collector Power Dissipation	$P_C$	150	mW
	Junction Temperature	$T_J$	125	°C
	Total Power Dissipation	$P_{tot}$	170	mW
1.	Isolation Voltage	$V_{iso}$	3750	$V_{rms}$
	Operating Temperature	$T_{opr}$	-55 ~ +110	°C
	Storage Temperature	$T_{stg}$	-55 ~ +150	°C
2.	Soldering Temperature	$T_{sol}$	260	°C

1. AC For 1 Minute, R.H. = 40 ~ 60%

Isolation voltage shall be measured using the following method.

- (1) Short between anode and cathode on the primary side and between collector and emitter on the secondary side.
- (2) The isolation voltage tester with zero-cross circuit shall be used.
- (3) The waveform of applied voltage shall be a sine wave.

2. For 10 Seconds

## Photocoupler LTV-352T series

### 4.2 ELECTRICAL OPTICAL CHARACTERISTICS at Ta=25°C

	Parameter	Symbol	Min.	Typ.	Max.	Unit	Test Condition
Input	Forward Voltage	$V_F$	—	1.2	1.4	V	$I_F=10\text{mA}$
	Reverse Current	$I_R$	—	—	10	$\mu\text{A}$	$V_R=4\text{V}$
	Terminal Capacitance	$C_t$	—	30	250	pF	$V=0, f=1\text{KHz}$
Output	Collector Dark Current	$I_{CEO}$	—	—	200	nA	$V_{CE}=200\text{V}, I_F=0$
	Collector-Emitter Breakdown Voltage	$BV_{CEO}$	300	—	—	V	$I_C=0.1\text{mA}, I_F=0$
	Emitter-Collector Breakdown Voltage	$BV_{ECO}$	0.1	—	—	V	$I_E=10\mu\text{A}, I_F=0$
TRANSFER CHARACTERISTICS	Collector Current	$I_C$	10	—	—	mA	$I_F=1\text{mA}$
	1. Current Transfer Ratio	CTR	1000	5000	—	%	$V_{CE}=2\text{V}$
	Collector-Emitter Saturation Voltage	$V_{CE(sat)}$	—	—	1.2	V	$I_F=20\text{mA}$ $I_C=100\text{mA}$
	Isolation Resistance	$R_{iso}$	$5 \times 10^{10}$	$1 \times 10^{11}$	—	$\Omega$	DC500V, 40 ~ 60% R.H.
	Floating Capacitance	$C_f$	—	0.6	1	pF	$V=0, f=1\text{MHz}$
	Cut-Off Frequency	$f_c$	1	7	—	kHz	$V_{CE}=2\text{V}, I_C=20\text{mA}$ $R_L=100\Omega, -3\text{dB}$
	Response Time (Rise)	$t_r$	—	100	300	$\mu\text{s}$	$V_{CE}=2\text{V},$ $I_C=20\text{mA}$
	Response Time (Fall)	$t_f$	—	20	100	$\mu\text{s}$	$R_L=100\Omega$

$$1. \text{ CTR} = \frac{I_C}{I_F} \times 100\%$$

## Photocoupler LTV-352T series

### 5. CHARACTERISTICS CURVES (TYPICAL PERFORMANCE)

Fig.1 Forward Current vs. Ambient Temperature

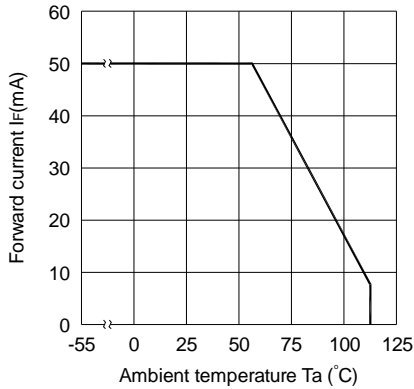

Fig.2 Collector Power Dissipation vs. Ambient Temperature

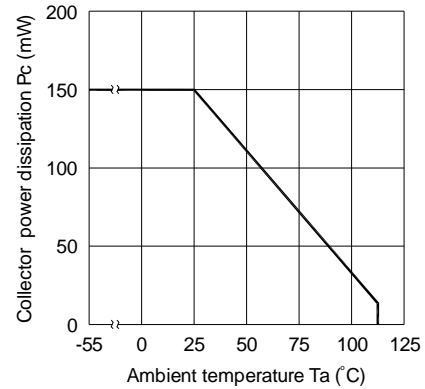

Fig.3 Collector-emitter saturation Voltage vs. Forward current

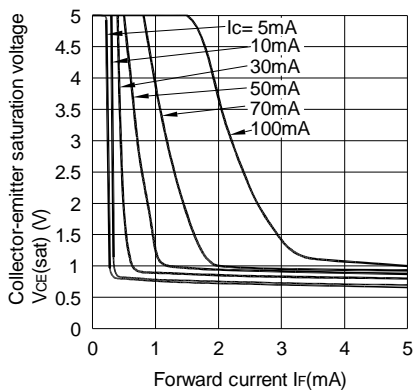

Fig.4 Forward Current vs. Forward Voltage

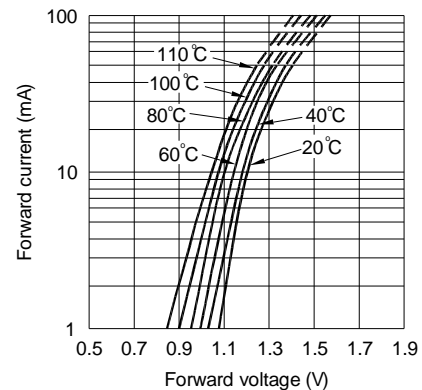

Fig.5 Current Transfer Ratio vs. Forward Current

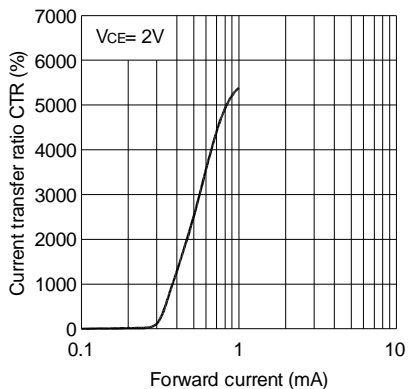
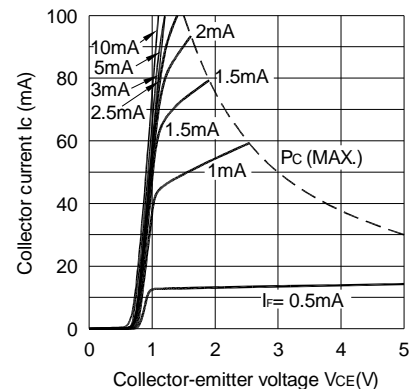

Fig.6 Collector Current vs. Collector-emitter Voltage



## Photocoupler LTV-352T series

Fig.7 Relative Current Transfer Ratio vs. Ambient Temperature

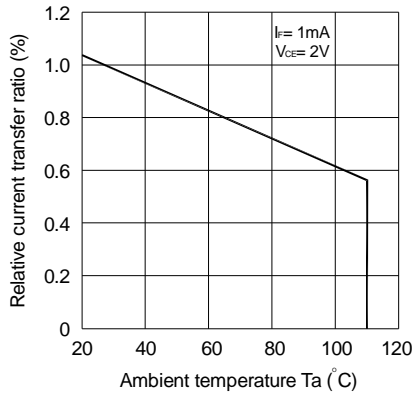

Fig.8 Collector-emitter Saturation Voltage vs. Ambient Temperature

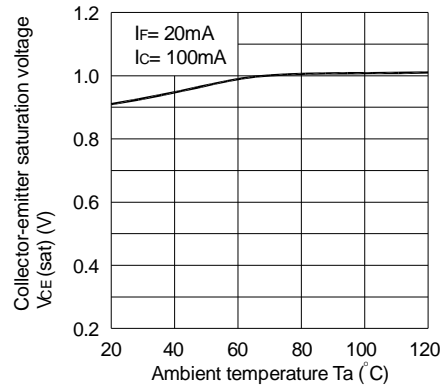

Fig.9 Collector Dark Current vs. Temperature

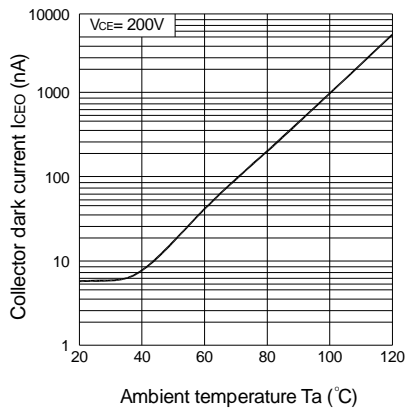

Fig.10 Response Time vs. Load Resistance

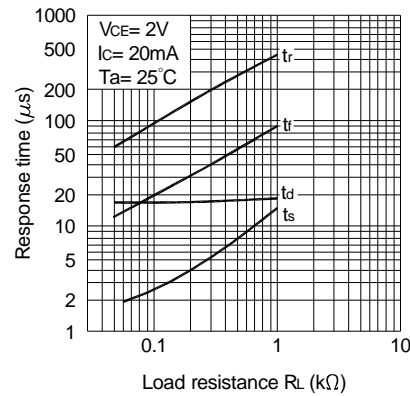
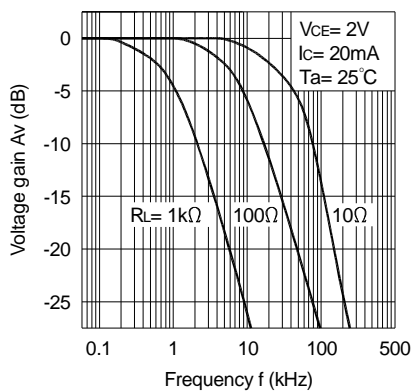
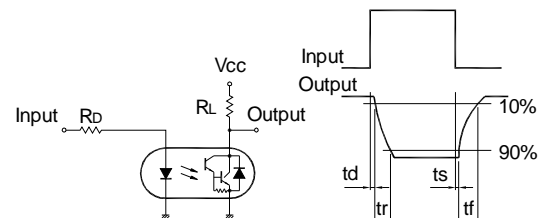

Fig.11 Frequency Response



Test Circuit for Response Time



Test Circuit for Frequency Response

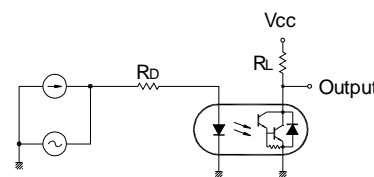

# Photocoupler LTV-352T series

## 6. TEMPERATURE PROFILE OF SOLDERING

### 6.1 IR Reflow soldering (JEDEC-STD-020C compliant)

One time soldering reflow is recommended within the condition of temperature and time profile shown below. Do not solder more than three times.

Profile item	Conditions
Preheat	
- Temperature Min ( $T_{Smin}$ )	150°C
- Temperature Max ( $T_{Smax}$ )	200°C
- Time (min to max) (ts)	90±30 sec
Soldering zone	
- Temperature ( $T_L$ )	217°C
- Time ( $t_L$ )	60 ~ 100 sec
Peak Temperature ( $T_P$ )	260°C
Ramp-up rate	3°C / sec max.
Ramp-down rate	3~6°C / sec

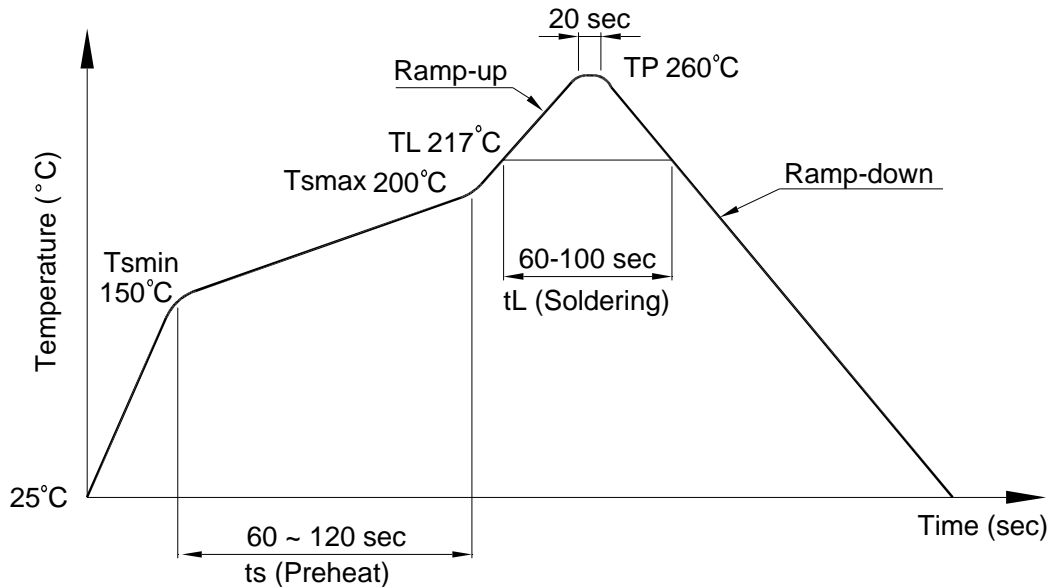

**Photocoupler  
LTV-352T series**

**6.2 Wave soldering (JEDEC22A111 compliant)**

One time soldering is recommended within the condition of temperature.

Temperature:  $260 \pm 0 / -5^{\circ}\text{C}$

Time: 10 sec.

Preheat temperature: 25 to  $140^{\circ}\text{C}$

Preheat time: 30 to 80 sec.

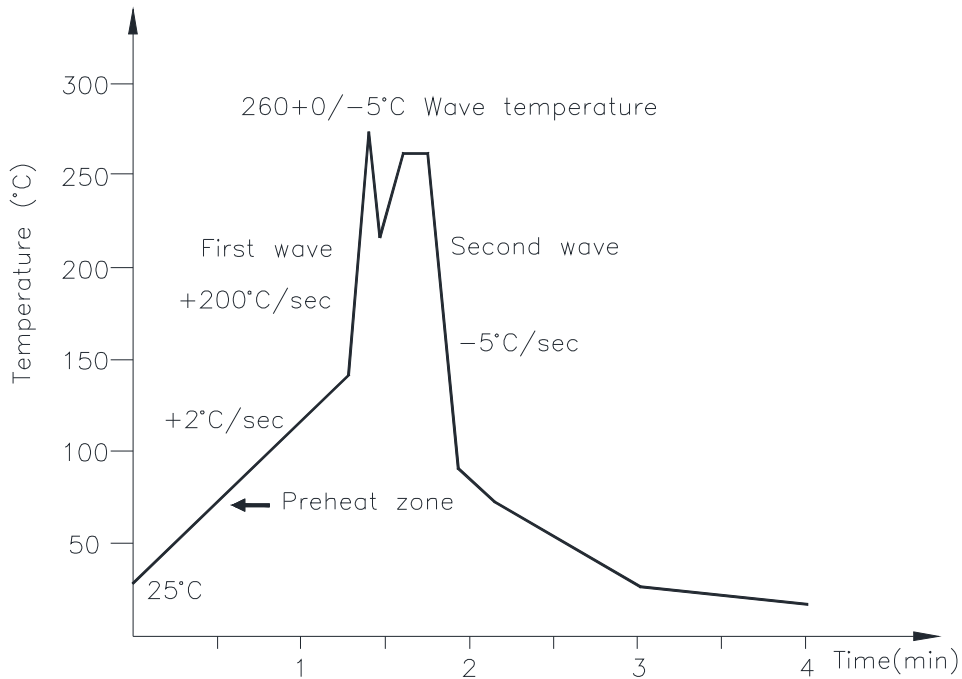

**6.3 Hand soldering by soldering iron**

Allow single lead soldering in every single process. One time soldering is recommended.

Temperature:  $380 \pm 0 / -5^{\circ}\text{C}$

Time: 3 sec max.

**Photocoupler  
LTV-352T series**

**7. RRECOMMENDED FOOT PRINT PATTERNS (MOUNT PAD)**

Unit: mm

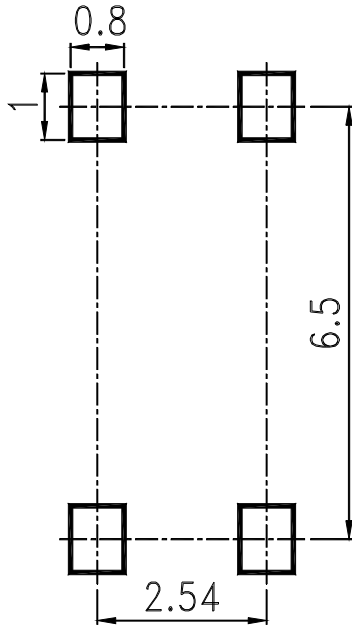

**Photocoupler  
LTV-352T series**

**8. NAMING RULE**

**LTV-352T-(1)-G**

DEVICE PART NUMBER

(1) TAPING TYPE (TP, no suffix)

LTV-352T has tape and reel solution.

Please refer to orientation of taping on Page P3

(2) Halogen free option

Example : LTV-352T-TP-G

**LTV 352T(1)-V-G**

DEVICE PART NUMBER

(1) TAPING TYPE (TP, no suffix)

LTV-352T has tape and reel solution.

Please refer to orientation of taping on Page P3

(2) VDE option

(3) Halogen free option

Example : LTV352TTP-V-G

**9. NOTES**

- LiteOn is continually improving the quality, reliability, function or design and LiteOn reserves the right to make changes without further notices.
- The products shown in this publication are designed for the general use in electronic applications such as office automation equipment, communications devices, audio/visual equipment, electrical application and instrumentation.
- For equipment/devices where high reliability or safety is required, such as space applications, nuclear power control equipment, medical equipment, etc, please contact our sales representatives.
- When requiring a device for any "specific" application, please contact our sales in advice.
- If there are any questions about the contents of this publication, please contact us at your convenience.
- The contents described herein are subject to change without prior notice.
- Immerge unit's body in solder paste is not recommended.