

OPA244
OPA2244
OPA4244

MicroPower, Single-Supply OPERATIONAL AMPLIFIERS MicroAmplifier™ Series

FEATURES

- **MicroSIZE PACKAGES**
 OPA244 (Single): SOT-23-5
 OPA2244 (Dual): MSOP-8
 OPA4244 (Quad): TSSOP-14
- **MicroPOWER:** $I_Q = 50\mu\text{A}/\text{channel}$
- **SINGLE SUPPLY OPERATION**
- **WIDE BANDWIDTH:** 430kHz
- **WIDE SUPPLY RANGE:**
 Single Supply: 2.2V to 36V
 Dual Supply: $\pm 1.1\text{V}$ to $\pm 18\text{V}$

APPLICATIONS

- **BATTERY POWERED SYSTEMS**
- **PORTABLE EQUIPMENT**
- **PCMCIA CARDS**
- **BATTERY PACKS AND POWER SUPPLIES**
- **CONSUMER PRODUCTS**

DESCRIPTION

The OPA244 (single), OPA2244 (dual), and OPA4244 (quad) op amps are designed for very low quiescent current ($50\mu\text{A}/\text{channel}$), yet achieve excellent bandwidth. Ideal for battery powered and portable instrumentation, all versions are offered in micro packages for space-limited applications. The dual and quad versions feature completely independent circuitry for lowest crosstalk and freedom from interaction, even when overdriven or overloaded.

The OPA244 series is easy to use and free from phase inversion and overload problems found in some other op amps. These amplifiers are stable in unity gain and excellent performance is maintained as they swing to their specified limits. They can be operated from single (+2.2V to +36V) or dual supplies ($\pm 1.1\text{V}$ to $\pm 18\text{V}$). The input common-mode voltage range includes ground—ideal for many single supply applications. All versions have similar performance. However, there are some differences, such as common-mode rejection. All versions are interchangeable in most applications.

All versions are offered in miniature, surface-mount packages. OPA244 (single version) comes in the tiny 5-lead SOT-23-5 surface mount, SO-8 surface mount, and 8-pin DIP. OPA2244 (dual version) is available in the MSOP-8 surface mount, SO-8 surface-mount, and 8-pin DIP. The OPA4244 (quad) comes in the TSSOP-14 surface mount. They are fully specified from -40°C to $+85^\circ\text{C}$ and operate from -55°C to $+125^\circ\text{C}$. A SPICE Macromodel is available for design analysis.

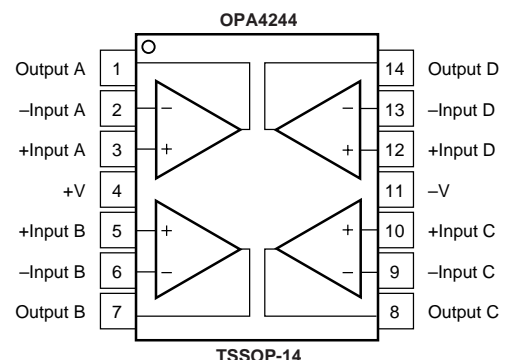
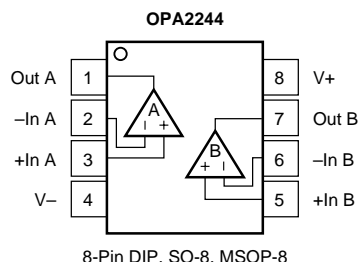
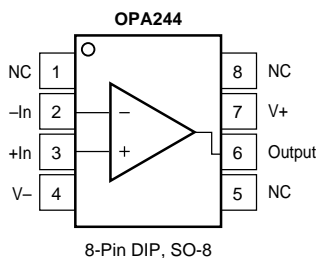
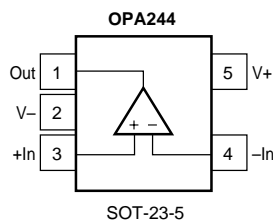

International Airport Industrial Park • Mailing Address: PO Box 11400, Tucson, AZ 85734 • Street Address: 6730 S. Tucson Blvd., Tucson, AZ 85706 • Tel: (520) 746-1111
 Twx: 910-952-1111 • Internet: <http://www.burr-brown.com/> • Cable: BBRCORP • Telex: 066-6491 • FAX: (520) 889-1510 • Immediate Product Info: (800) 548-6132

SPECIFICATIONS: $V_S = +2.6V$ to $+36V$

Boldface limits apply over the specified temperature range, $T_A = -40^{\circ}C$ to $+85^{\circ}C$

At $T_A = +25^{\circ}C$, $R_L = 20k\Omega$ connected to ground, unless otherwise noted.

PARAMETER	CONDITION	OPA244NA, PA, UA			UNITS
		MIN	TYP ⁽¹⁾	MAX	
OFFSET VOLTAGE Input Offset Voltage $T_A = -40^{\circ}C$ to $85^{\circ}C$ vs Temperature vs Power Supply $T_A = -40^{\circ}C$ to $85^{\circ}C$	V_{OS} $V_S = \pm 7.5V, V_{CM} = 0$ dV_{OS}/dT $PSRR$ $T_A = -40^{\circ}C$ to $85^{\circ}C$ $V_S = +2.6V$ to $+36V$ $V_S = +2.6V$ to $+36V$		± 0.7 ± 4 5	± 1.5 ± 2 50 50	mV mV $\mu V/^{\circ}C$ $\mu V/V$ $\mu V/V$
INPUT BIAS CURRENT Input Bias Current Input Offset Current	I_B I_{OS} $V_{CM} = V_S/2$ $V_{CM} = V_S/2$		-10 ± 1	-25 ± 10	nA nA
NOISE Input Voltage Noise, $f = 0.1kHz$ to $10kHz$ Input Voltage Noise Density, $f = 1kHz$ Current Noise Density, $f = 1kHz$	e_n i_n		0.4 22 40		$\mu Vp-p$ nV/\sqrt{Hz} fA/\sqrt{Hz}
INPUT VOLTAGE RANGE Common-Mode Voltage Range Common-Mode Rejection $T_A = -40^{\circ}C$ to $85^{\circ}C$	V_{CM} CMRR $V_S = \pm 18V, V_{CM} = -18V$ to $+17.1V$ $V_S = \pm 18V, V_{CM} = -18V$ to $+17.1V$	0 84 84	98	$(V+) - 0.9$	V dB dB
INPUT IMPEDANCE Differential Common-Mode			$10^6 \parallel 2$ $10^9 \parallel 2$		$\Omega \parallel pF$ $\Omega \parallel pF$
OPEN-LOOP GAIN Open-Loop Voltage Gain $T_A = -40^{\circ}C$ to $85^{\circ}C$	A_{OL} $V_O = 0.5V$ to $(V+) - 0.9$ $V_O = 0.5V$ to $(V+) - 0.9$	86 86	106		dB dB
FREQUENCY RESPONSE Gain-Bandwidth Product Slew Rate Settling Time 0.01% Overload Recovery Time	GBW SR $G = 1$ 10V Step $V_{IN} \cdot \text{Gain} = V_S$		430 -0.1/+0.16 150 8		kHz V/ μs μs μs
OUTPUT Voltage Output, Positive $T_A = -40^{\circ}C$ to $85^{\circ}C$ Voltage Output, Negative $T_A = -40^{\circ}C$ to $85^{\circ}C$ Voltage Output, Positive $T_A = -40^{\circ}C$ to $85^{\circ}C$ Voltage Output, Negative $T_A = -40^{\circ}C$ to $85^{\circ}C$ Short-Circuit Current Capacitive Load Drive	V_O $A_{OL} \geq 80dB, R_L = 20k\Omega$ to $V_S/2$ $A_{OL} \geq 80dB, R_L = 20k\Omega$ to $V_S/2$ $A_{OL} \geq 80dB, R_L = 20k\Omega$ to $V_S/2$ $A_{OL} \geq 80dB, R_L = 20k\Omega$ to $V_S/2$ $A_{OL} \geq 80dB, R_L = 20k\Omega$ to Ground $A_{OL} \geq 80dB, R_L = 20k\Omega$ to Ground $A_{OL} \geq 80dB, R_L = 20k\Omega$ to Ground $A_{OL} \geq 80dB, R_L = 20k\Omega$ to Ground $A_{OL} \geq 80dB, R_L = 20k\Omega$ to Ground I_{SC} C_{LOAD}	$(V+) - 0.9$ $(V+) - 0.9$ 0.5 0.5 0.1 0.1 -25/+12	$(V+) - 0.75$ $(V+) - 0.75$ 0.2 0.2 $(V+) - 0.75$ $(V+) - 0.75$ 0.1 0.1 -25/+12		V V V V V V V V mA
POWER SUPPLY Specified Voltage Range Minimum Operating Voltage Quiescent Current $T_A = -40^{\circ}C$ to $85^{\circ}C$	V_S I_Q $T_A = -40^{\circ}C$ to $85^{\circ}C$ $I_O = 0$ $I_O = 0$	+2.6	+2.2 50	+36 60 70	V V μA μA
TEMPERATURE RANGE Specified Range Operating Range Storage Range Thermal Resistance SOT-23-5 Surface-Mount SO-8 Surface-Mount 8-Pin DIP	θ_{JA}	-40 -55 -65		85 125 150	$^{\circ}C$ $^{\circ}C$ $^{\circ}C$ $^{\circ}C/W$ $^{\circ}C/W$ $^{\circ}C/W$

NOTE: (1) $V_S = +15V$.

The information provided herein is believed to be reliable; however, BURR-BROWN assumes no responsibility for inaccuracies or omissions. BURR-BROWN assumes no responsibility for the use of this information, and all use of such information shall be entirely at the user's own risk. Prices and specifications are subject to change without notice. No patent rights or licenses to any of the circuits described herein are implied or granted to any third party. BURR-BROWN does not authorize or warrant any BURR-BROWN product for use in life support devices and/or systems.

SPECIFICATIONS: $V_S = +2.6V$ to $+36V$

Boldface limits apply over the specified temperature range, $T_A = -40^{\circ}C$ to $+85^{\circ}C$

At $T_A = +25^{\circ}C$, $R_L = 20k\Omega$ connected to ground, unless otherwise noted.

PARAMETER	CONDITION	OPA2244EA, PA, UA			UNITS
		MIN	TYP ⁽¹⁾	MAX	
OFFSET VOLTAGE Input Offset Voltage $T_A = -40^{\circ}C$ to $85^{\circ}C$ vs Temperature vs Power Supply $T_A = -40^{\circ}C$ to $85^{\circ}C$ Channel Separation	V_{OS} $V_S = \pm 7.5V, V_{CM} = 0$ dV_{OS}/dT $PSRR$ $T_A = -40^{\circ}C$ to $85^{\circ}C$ $V_S = +2.6V$ to $+36V$ $V_S = +2.6V$ to $+36V$		± 0.7 ± 4 5 140	± 1.5 ± 2 50 50	mV mV $\mu V/^{\circ}C$ $\mu V/V$ $\mu V/V$ dB
INPUT BIAS CURRENT Input Bias Current Input Offset Current	I_B I_{OS} $V_{CM} = V_S/2$ $V_{CM} = V_S/2$		-10 ± 1	-25 ± 10	nA nA
NOISE Input Voltage Noise, $f = 0.1kHz$ to $10kHz$ Input Voltage Noise Density, $f = 1kHz$ Current Noise Density, $f = 1kHz$	e_n i_n		0.4 22 40		$\mu Vp-p$ nV/\sqrt{Hz} fA/\sqrt{Hz}
INPUT VOLTAGE RANGE Common-Mode Voltage Range Common-Mode Rejection $T_A = -40^{\circ}C$ to $85^{\circ}C$	V_{CM} CMRR $V_S = \pm 18V, V_{CM} = -18V$ to $+17.1V$ $V_S = \pm 18V, V_{CM} = -18V$ to $+17.1V$	0 72 72	98	$(V+) - 0.9$	V dB dB
INPUT IMPEDANCE Differential Common-Mode			$10^6 \parallel 2$ $10^9 \parallel 2$		$\Omega \parallel pF$ $\Omega \parallel pF$
OPEN-LOOP GAIN Open-Loop Voltage Gain $T_A = -40^{\circ}C$ to $85^{\circ}C$	A_{OL} $V_O = 0.5V$ to $(V+) - 0.9$ $V_O = 0.5V$ to $(V+) - 0.9$	86 86	106		dB dB
FREQUENCY RESPONSE Gain-Bandwidth Product Slew Rate Settling Time 0.01% Overload Recovery Time	GBW SR G = 1 10V Step $V_{IN} \cdot \text{Gain} = V_S$		430 $-0.1/+0.16$ 150 8		kHz V/ μs μs μs
OUTPUT Voltage Output, Positive $T_A = -40^{\circ}C$ to $85^{\circ}C$ Voltage Output, Negative $T_A = -40^{\circ}C$ to $85^{\circ}C$ Voltage Output, Positive $T_A = -40^{\circ}C$ to $85^{\circ}C$ Voltage Output, Negative $T_A = -40^{\circ}C$ to $85^{\circ}C$ Short-Circuit Current Capacitive Load Drive	V_O $A_{OL} \geq 80dB, R_L = 20k\Omega$ to $V_S/2$ $A_{OL} \geq 80dB, R_L = 20k\Omega$ to $V_S/2$ $A_{OL} \geq 80dB, R_L = 20k\Omega$ to $V_S/2$ $A_{OL} \geq 80dB, R_L = 20k\Omega$ to $V_S/2$ $A_{OL} \geq 80dB, R_L = 20k\Omega$ to Ground $A_{OL} \geq 80dB, R_L = 20k\Omega$ to Ground $A_{OL} \geq 80dB, R_L = 20k\Omega$ to Ground $A_{OL} \geq 80dB, R_L = 20k\Omega$ to Ground $A_{OL} \geq 80dB, R_L = 20k\Omega$ to Ground I_{SC} C_{LOAD}	$(V+) - 0.9$ $(V+) - 0.9$ 0.5 0.5 0.1 0.1 $-25/+12$	$(V+) - 0.75$ $(V+) - 0.75$ 0.2 0.2 $(V+) - 0.75$ $(V+) - 0.75$ 0.1 0.1 See Typical Curve		V V V V V V V V mA
POWER SUPPLY Specified Voltage Range Minimum Operating Voltage Quiescent Current (per amplifier) $T_A = -40^{\circ}C$ to $85^{\circ}C$	V_S I_Q $T_A = -40^{\circ}C$ to $85^{\circ}C$ $I_O = 0$ $I_O = 0$	+2.6	+2.2 40	+36 50 63	V V μA μA
TEMPERATURE RANGE Specified Range Operating Range Storage Range Thermal Resistance MSOP-8 Surface-Mount SO-8 Surface-Mount 8-Pin DIP	θ_{JA}	-40 -55 -65		85 125 150	$^{\circ}C$ $^{\circ}C$ $^{\circ}C$ $^{\circ}C/W$ $^{\circ}C/W$ $^{\circ}C/W$

NOTE: (1) $V_S = +15V$.

SPECIFICATIONS: $V_S = +2.6V$ to $+36V$

Boldface limits apply over the specified temperature range, $T_A = -40^\circ\text{C}$ to $+85^\circ\text{C}$

At $T_A = +25^\circ\text{C}$, $R_L = 20\text{k}\Omega$ connected to ground, unless otherwise noted.

PARAMETER	CONDITION	OPA4244EA			UNITS
		MIN	TYP ⁽¹⁾	MAX	
OFFSET VOLTAGE Input Offset Voltage $T_A = -40^\circ\text{C}$ to 85°C vs Temperature vs Power Supply $T_A = -40^\circ\text{C}$ to 85°C Channel Separation	V_{OS} $V_S = \pm 7.5V, V_{CM} = 0$ dV_{OS}/dT $PSRR$ $T_A = -40^\circ\text{C}$ to 85°C $V_S = +2.6V$ to $+36V$ $V_S = +2.6V$ to $+36V$		± 0.7 ± 4 5 140	± 1.5 ± 2 50 50	mV mV $\mu\text{V}/^\circ\text{C}$ $\mu\text{V}/V$ $\mu\text{V}/V$ dB
INPUT BIAS CURRENT Input Bias Current Input Offset Current	I_B I_{OS} $V_{CM} = V_S/2$ $V_{CM} = V_S/2$		-10 ± 1	-25 ± 10	nA nA
NOISE Input Voltage Noise, $f = 0.1\text{kHz}$ to 10kHz Input Voltage Noise Density, $f = 1\text{kHz}$ Current Noise Density, $f = 1\text{kHz}$	e_n i_n		0.4 22 40		$\mu\text{Vp-p}$ $\text{nV}/\sqrt{\text{Hz}}$ $\text{fA}/\sqrt{\text{Hz}}$
INPUT VOLTAGE RANGE Common-Mode Voltage Range Common-Mode Rejection $T_A = -40^\circ\text{C}$ to 85°C	V_{CM} CMRR $V_S = \pm 18V, V_{CM} = -18V$ to $+17.1V$ $V_S = \pm 18V, V_{CM} = -18V$ to $+17.1V$	0 82 82		$(V+) - 0.9$ 104	V dB dB
INPUT IMPEDANCE Differential Common-Mode			$10^6 \parallel 2$ $10^9 \parallel 2$		$\Omega \parallel \text{pF}$ $\Omega \parallel \text{pF}$
OPEN-LOOP GAIN Open-Loop Voltage Gain $T_A = -40^\circ\text{C}$ to 85°C	A_{OL} $V_O = 0.5V$ to $(V+) - 0.9$ $V_O = 0.5V$ to $(V+) - 0.9$	86 86	106		dB dB
FREQUENCY RESPONSE Gain-Bandwidth Product Slew Rate Settling Time 0.01% Overload Recovery Time	GBW SR $G = 1$ 10V Step $V_{IN} \cdot \text{Gain} = V_S$		430 $-0.1/+0.16$ 150 8		kHz $\text{V}/\mu\text{s}$ μs μs
OUTPUT Voltage Output, Positive $T_A = -40^\circ\text{C}$ to 85°C Voltage Output, Negative $T_A = -40^\circ\text{C}$ to 85°C Voltage Output, Positive $T_A = -40^\circ\text{C}$ to 85°C Voltage Output, Negative $T_A = -40^\circ\text{C}$ to 85°C Short-Circuit Current Capacitive Load Drive	V_O I_{SC} C_{LOAD} $A_{OL} \geq 80\text{dB}, R_L = 20\text{k}\Omega$ to $V_S/2$ $A_{OL} \geq 80\text{dB}, R_L = 20\text{k}\Omega$ to $V_S/2$ $A_{OL} \geq 80\text{dB}, R_L = 20\text{k}\Omega$ to $V_S/2$ $A_{OL} \geq 80\text{dB}, R_L = 20\text{k}\Omega$ to $V_S/2$ $A_{OL} \geq 80\text{dB}, R_L = 20\text{k}\Omega$ to Ground $A_{OL} \geq 80\text{dB}, R_L = 20\text{k}\Omega$ to Ground $A_{OL} \geq 80\text{dB}, R_L = 20\text{k}\Omega$ to Ground $A_{OL} \geq 80\text{dB}, R_L = 20\text{k}\Omega$ to Ground $A_{OL} \geq 80\text{dB}, R_L = 20\text{k}\Omega$ to Ground $A_{OL} \geq 80\text{dB}, R_L = 20\text{k}\Omega$ to Ground $A_{OL} \geq 80\text{dB}, R_L = 20\text{k}\Omega$ to Ground	$(V+) - 0.9$ $(V+) - 0.9$ 0.5 0.5 0.1 0.1 $-25/+12$	$(V+) - 0.75$ $(V+) - 0.75$ 0.2 0.2 $(V+) - 0.75$ $(V+) - 0.75$ 0.1 0.1 $-25/+12$		V V V V V V V V mA
POWER SUPPLY Specified Voltage Range Minimum Operating Voltage Quiescent Current (per amplifier) $T_A = -40^\circ\text{C}$ to 85°C	V_S I_Q $T_A = -40^\circ\text{C}$ to 85°C $I_O = 0$ $I_O = 0$	+2.6	+2.2 40	+36 60 70	V V μA μA
TEMPERATURE RANGE Specified Range Operating Range Storage Range Thermal Resistance TSSOP-14 Surface Mount	θ_{JA}	-40 -55 -65		85 125 150	$^\circ\text{C}$ $^\circ\text{C}$ $^\circ\text{C}$ $^\circ\text{C}/W$

NOTE: (1) $V_S = +15V$.

ABSOLUTE MAXIMUM RATINGS⁽¹⁾

Supply Voltage, V+ to V-	36V
Input Voltage Range ⁽²⁾	(V-) – 0.3V to (V+) + 0.3V
Input Current ⁽²⁾	10mA
Output Short-Circuit ⁽³⁾	Continuous
Operating Temperature	–55°C to +125°C
Storage Temperature	–65°C to +150°C
Junction Temperature	150°C
Lead Temperature (soldering, 10s)	300°C
ESD Capability	2000V

NOTES: (1) Stresses above these ratings may cause permanent damage. Exposure to absolute maximum conditions for extended periods may degrade device reliability. (2) Inputs are diode-clamped to the supply rails and should be current-limited to 10mA or less if input voltages can exceed rails by more than 0.3V. (3) Short-circuit to ground, one amplifier per package.



ELECTROSTATIC DISCHARGE SENSITIVITY

This integrated circuit can be damaged by ESD. Burr-Brown recommends that all integrated circuits be handled with appropriate precautions. Failure to observe proper handling and installation procedures can cause damage.

ESD damage can range from subtle performance degradation to complete device failure. Precision integrated circuits may be more susceptible to damage because very small parametric changes could cause the device not to meet its published specifications.

PACKAGE/ORDERING INFORMATION

PRODUCT	PACKAGE	PACKAGE DRAWING NUMBER	SPECIFIED TEMPERATURE RANGE	PACKAGE MARKING	ORDERING NUMBER ⁽¹⁾	TRANSPORT MEDIA
Single						
OPA244NA	SOT-23-5 Surface-Mount	331	–40°C to +85°C	A44	OPA244NA/250	Tape and Reel
"	"	"	"	"	OPA244NA/3K	Tape and Reel
OPA244PA	8-Pin DIP	006	–40°C to +85°C	OPA244PA	OPA244PA	Rails
OPA244UA	SO-8 Surface-Mount	182	–40°C to +85°C	OPA244UA	OPA244UA	Rails
"	"	"	"	"	OPA244UA/2K5	Tape and Reel
Dual						
OPA2244EA	MSOP-8 Surface-Mount	337	–40°C to +85°C	A44	OPA2244EA/250	Tape and Reel
"	"	"	"	"	OPA2244EA/2K5	Tape and Reel
OPA2244PA	8-Pin DIP	006	–40°C to +85°C	OPA2244PA	OPA2244PA	Rails
OPA2244UA	SO-8 Surface-Mount	182	–40°C to +85°C	OPA2244UA	OPA2244UA	Rails
"	"	"	"	"	OPA2244UA/2K5	Tape and Reel
Quad						
OPA4244EA	TSSOP-14 Surface-Mount	357	–40°C to +85°C	OPA4244EA	OPA4244EA/250	Tape and Reel
"	"	"	"	"	OPA4244EA/2K5	Tape and Reel

NOTE: (1) Products followed by a slash (/) are only available in Tape and Reel in the quantities indicated (e.g., /250 indicates 250 devices per reel). Ordering 3000 pieces of "OPA244NA/3K" will get a single 3000 piece Tape and Reel.

TYPICAL PERFORMANCE CURVES

At $T_A = 25^\circ\text{C}$, $V_S = +15\text{V}$, and $R_L = 20\text{k}\Omega$ connected to Ground, unless otherwise noted.

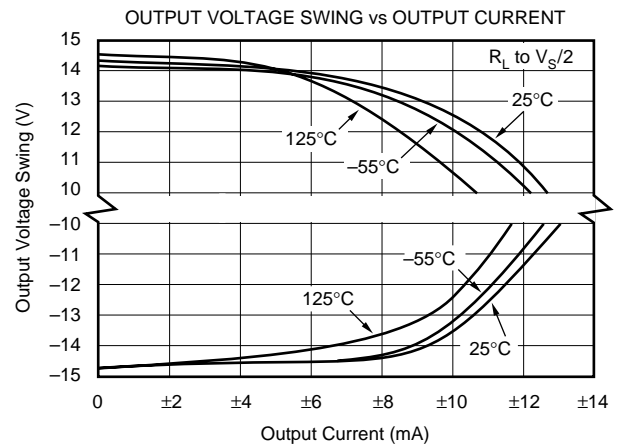
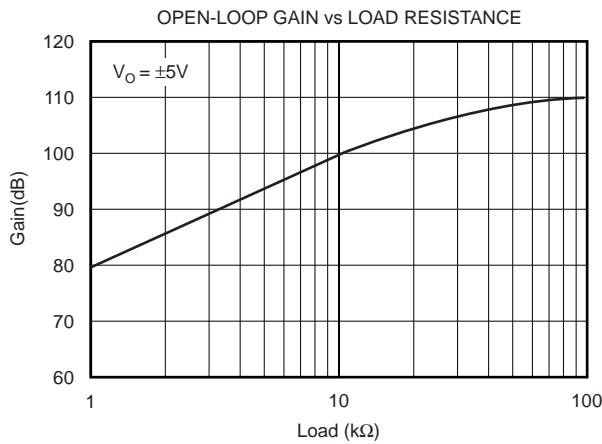
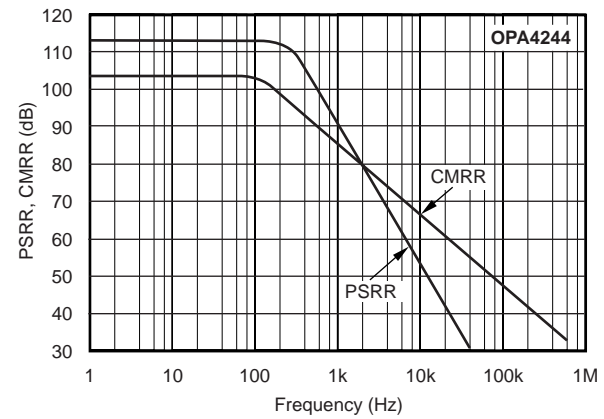
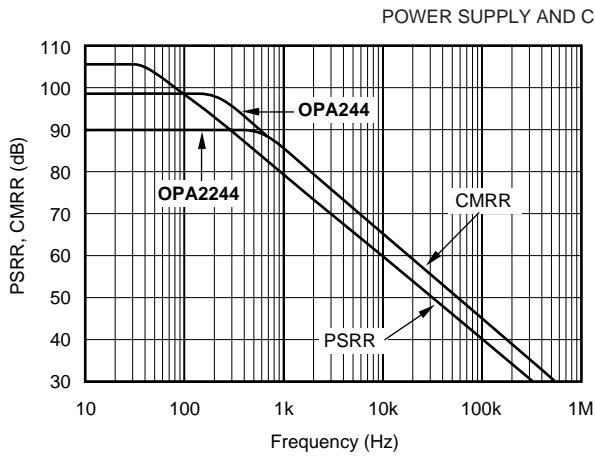
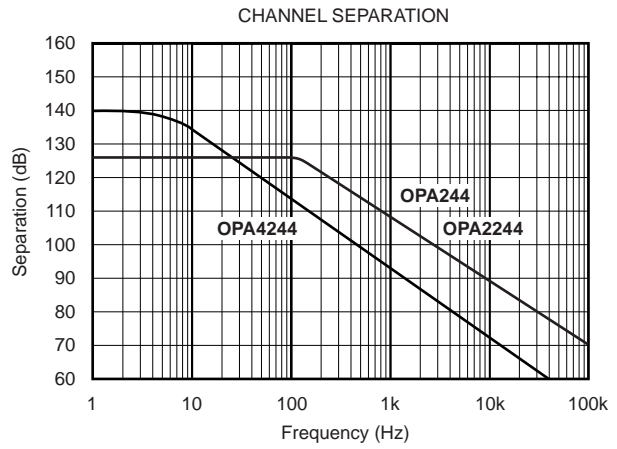
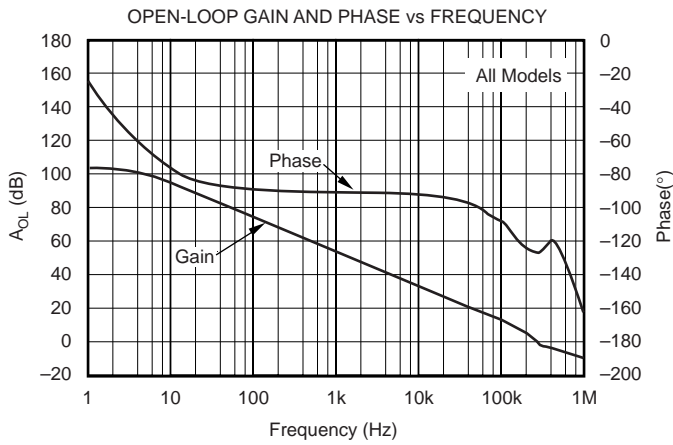

TYPICAL PERFORMANCE CURVES (Cont.)

At $T_A = 25^\circ\text{C}$, $V_S = +15\text{V}$, and $R_L = 20\text{k}\Omega$ connected to Ground, unless otherwise noted.

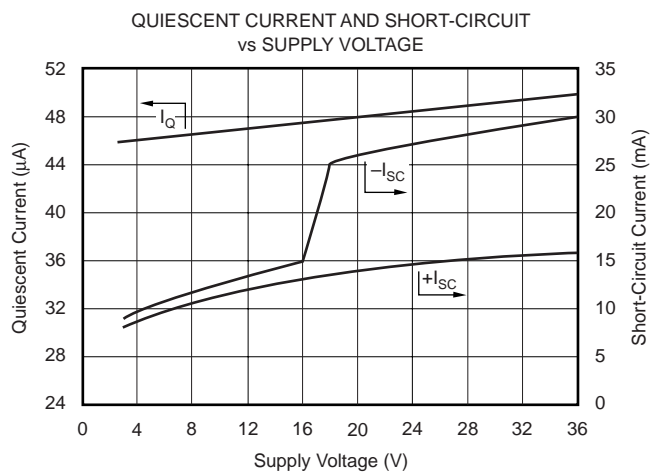
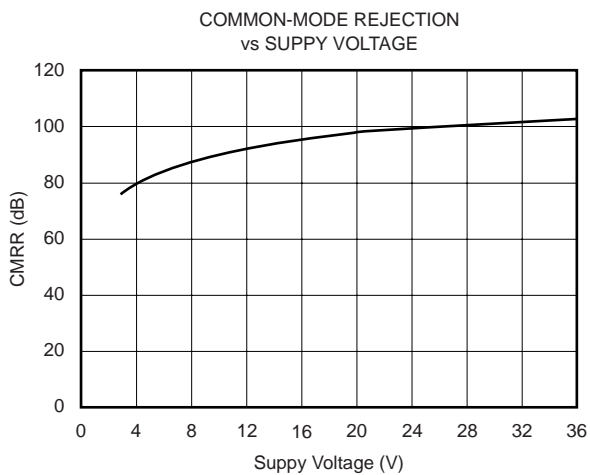
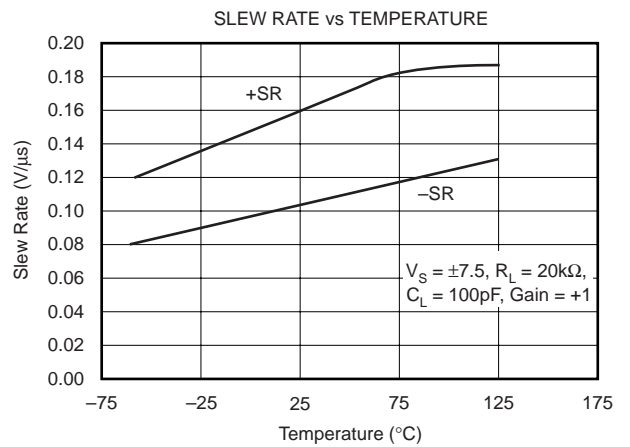
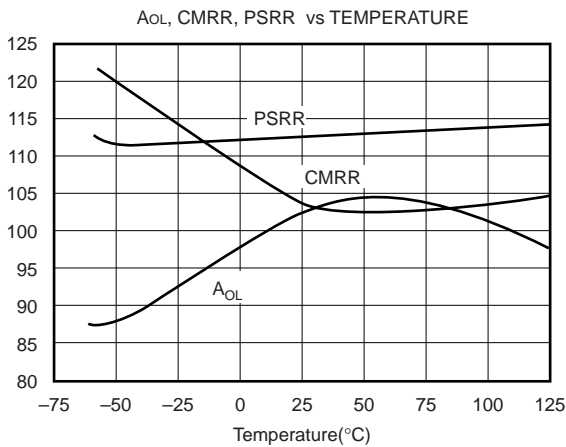
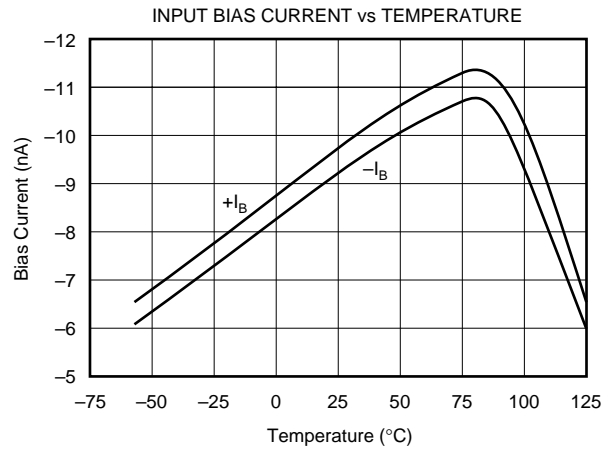
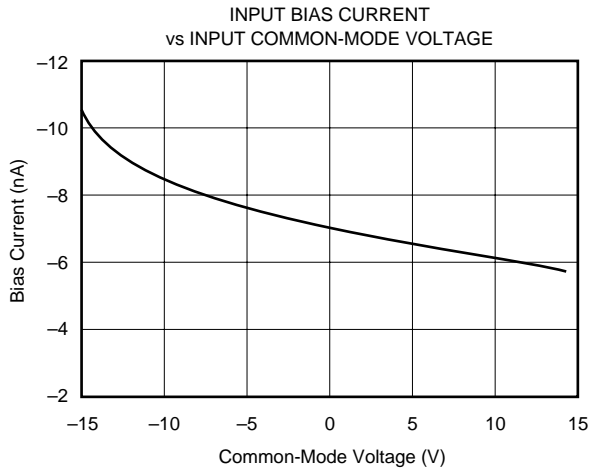

TYPICAL PERFORMANCE CURVES (Cont.)

At $T_A = 25^\circ\text{C}$, $V_S = +15\text{V}$, and $R_L = 20\text{k}\Omega$ connected to Ground, unless otherwise noted.

QUIESCENT AND SHORT-CIRCUIT CURRENT vs TEMPERATURE

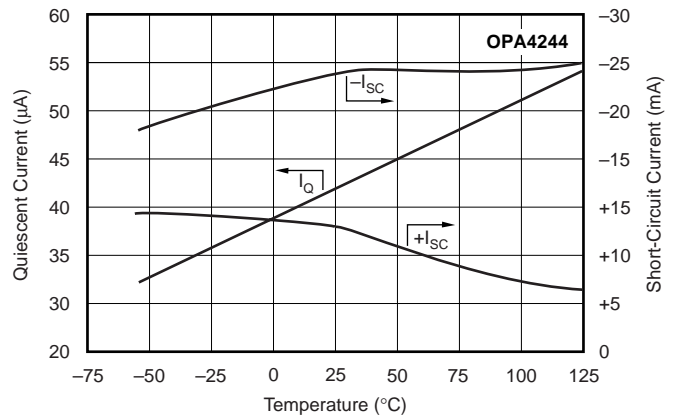
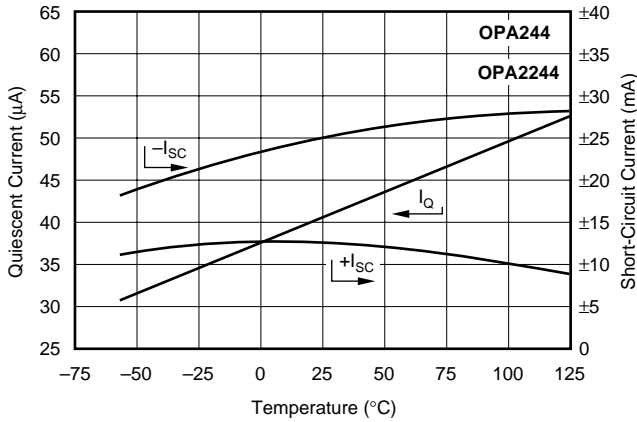

INPUT VOLTAGE AND CURRENT NOISE SPECTRAL DENSITY vs FREQUENCY

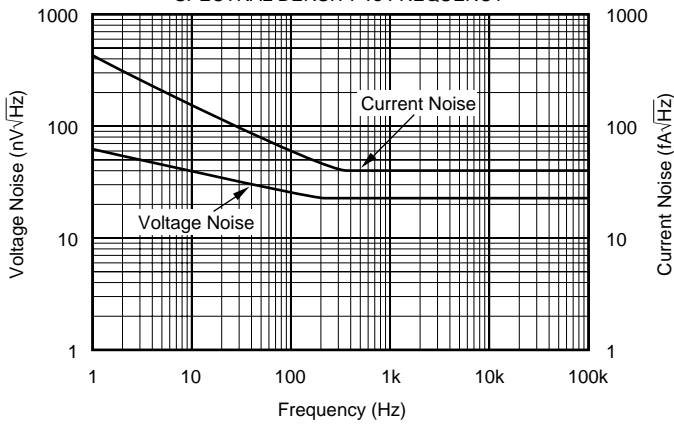

MAXIMUM OUTPUT VOLTAGE vs FREQUENCY

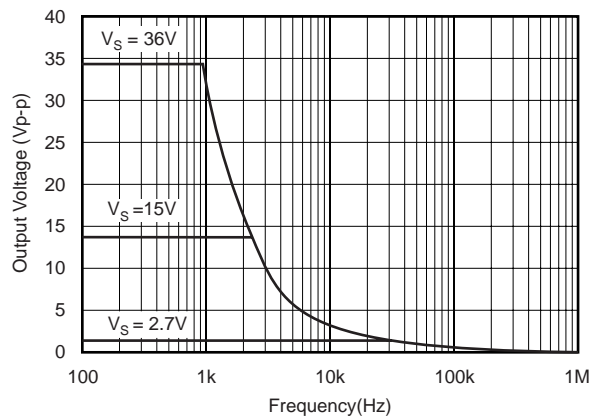

SMALL SIGNAL OVERSHOOT vs LOAD CAPACITANCE

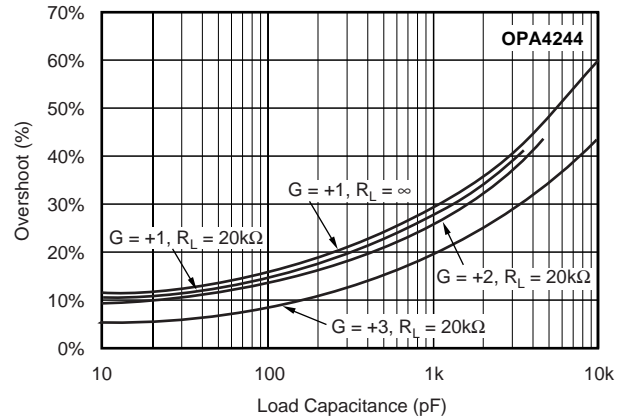
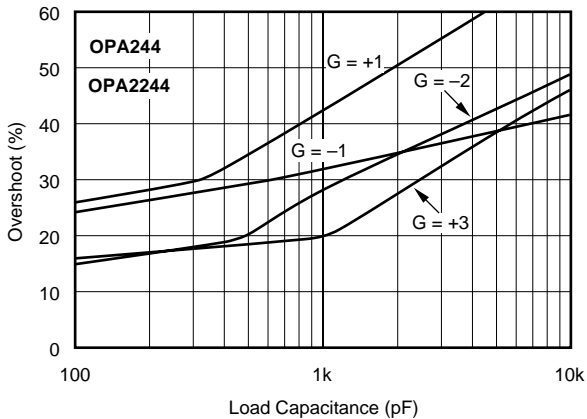

TYPICAL PERFORMANCE CURVES (Cont.)

At $T_A = 25^\circ\text{C}$, $V_S = +15\text{V}$, and $R_L = 20\text{k}\Omega$ connected to Ground, unless otherwise noted.

LARGE-SIGNAL STEP RESPONSE, $G = 1$, $C_L = 100\text{pF}$

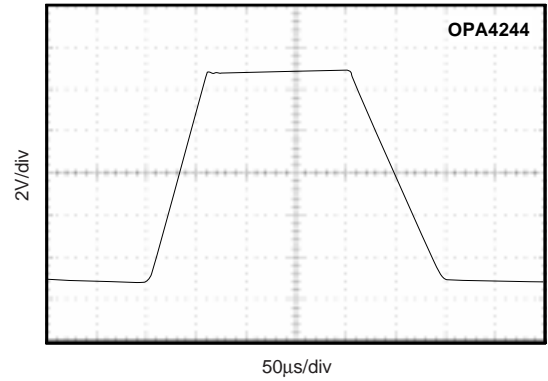
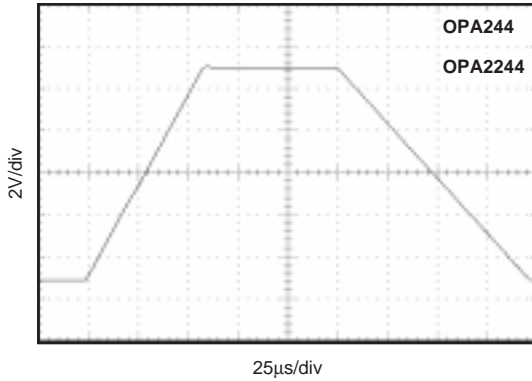

SMALL-SIGNAL STEP RESPONSE, $G = 1$, $C_L = 100\text{pF}$

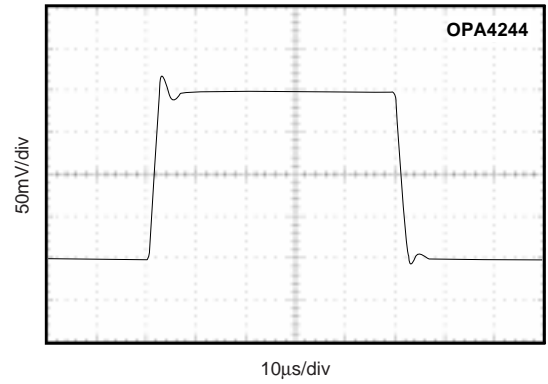
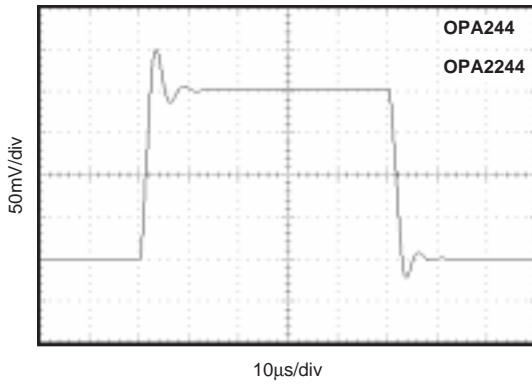

OFFSET VOLTAGE PRODUCTION DISTRIBUTION

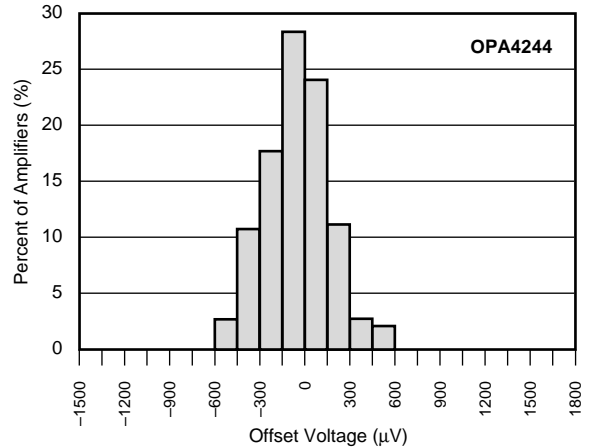
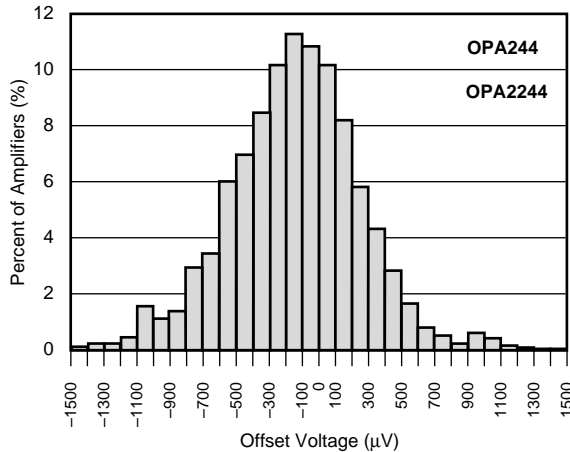

TYPICAL PERFORMANCE CURVES (Cont.)

At $T_A = 25^\circ\text{C}$, $V_S = +15\text{V}$, and $R_L = 20\text{k}\Omega$ connected to Ground, unless otherwise noted.

OFFSET VOLTAGE PRODUCTION DISTRIBUTION

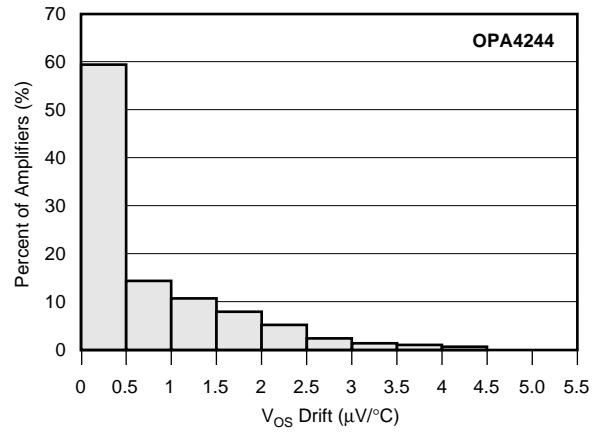
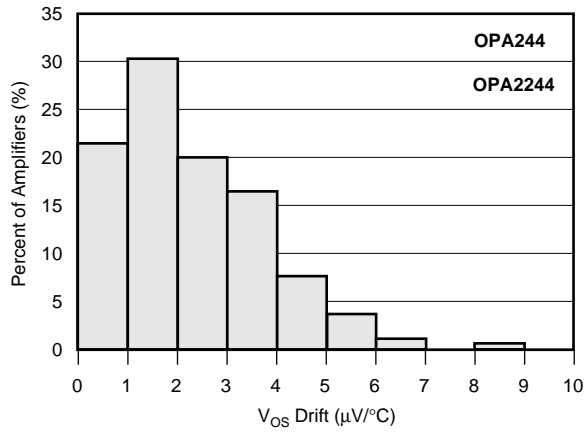

APPLICATIONS INFORMATION

The OPA244 is unity-gain stable and suitable for a wide range of general purpose applications. Power supply pins should be bypassed with 0.01µF ceramic capacitors.

OPERATING VOLTAGE

The OPA244 can operate from single supply (+2.2V to +36V) or dual supplies (±1.1 to ±18V) with excellent performance. Unlike most op amps which are specified at only one supply voltage, the OPA244 is specified for real world applications; a single set of specifications applies throughout the +2.6V to +36V (±1.3 to ±18V) supply range.

This allows a designer to have the same assured performance at any supply voltage within this range. In addition, many key parameters are guaranteed over the specified temperature range, -40°C to +85°C. Most behavior remains unchanged throughout the full operating voltage range. Parameters which vary significantly with operating voltage or temperature are shown in typical performance curves.

Useful information on solder pad design for printed circuit boards can be found in Burr-Brown's Application Bulletin AB-132B, "Solder Pad Recommendations for Surface-Mount Devices," easily found at Burr-Brown's web site (<http://www.burr-brown.com>).

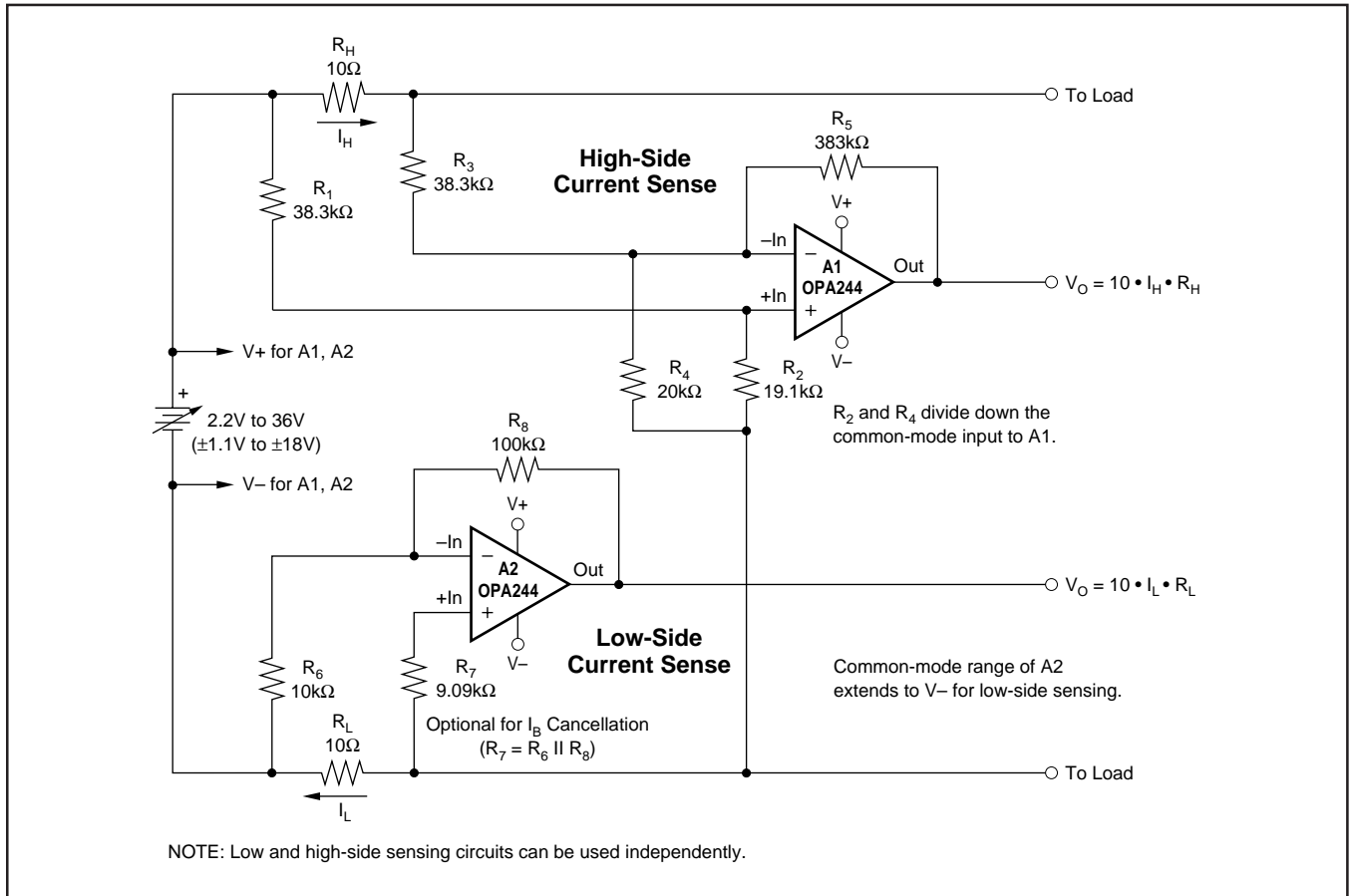

FIGURE 1. Low and High-Side Battery Current Sensing.

PACKAGING INFORMATION

Orderable Device	Status ⁽¹⁾	Package Type	Package Drawing	Pins	Package Qty	Eco Plan ⁽²⁾	Lead/Ball Finish	MSL Peak Temp ⁽³⁾
OPA2244EA/250	ACTIVE	MSOP	DGK	8	250	Green (RoHS & no Sb/Br)	CU NIPDAU	Level-2-260C-1 YEAR
OPA2244EA/250E4	PREVIEW	MSOP	DGK	8	250	TBD	Call TI	Call TI
OPA2244EA/250G4	ACTIVE	MSOP	DGK	8	250	Green (RoHS & no Sb/Br)	CU NIPDAU	Level-2-260C-1 YEAR
OPA2244EA/2K5	ACTIVE	MSOP	DGK	8	2500	Green (RoHS & no Sb/Br)	CU NIPDAU	Level-2-260C-1 YEAR
OPA2244EA/2K5E4	PREVIEW	MSOP	DGK	8	2500	TBD	Call TI	Call TI
OPA2244EA/2K5G4	ACTIVE	MSOP	DGK	8	2500	Green (RoHS & no Sb/Br)	CU NIPDAU	Level-2-260C-1 YEAR
OPA2244PA	ACTIVE	PDIP	P	8	50	Green (RoHS & no Sb/Br)	CU NIPDAU	N / A for Pkg Type
OPA2244UA	ACTIVE	SOIC	D	8	100	Green (RoHS & no Sb/Br)	CU NIPDAU	Level-3-260C-168 HR
OPA2244UA/2K5	ACTIVE	SOIC	D	8	2500	Pb-Free (RoHS)	CU NIPDAU	Level-3-260C-168 HR
OPA2244UAG4	ACTIVE	SOIC	D	8	100	Green (RoHS & no Sb/Br)	CU NIPDAU	Level-3-260C-168 HR
OPA244NA/250	ACTIVE	SOT-23	DBV	5	250	TBD	CU NIPDAU	Level-3-220C-168 HR
OPA244NA/3K	ACTIVE	SOT-23	DBV	5	3000	TBD	CU NIPDAU	Level-3-220C-168 HR
OPA244PA	ACTIVE	PDIP	P	8	50	Green (RoHS & no Sb/Br)	CU NIPDAU	N / A for Pkg Type
OPA244UA	ACTIVE	SOIC	D	8	100	Pb-Free (RoHS)	CU NIPDAU	Level-3-260C-168 HR
OPA244UA/2K5	ACTIVE	SOIC	D	8	2500	Pb-Free (RoHS)	CU NIPDAU	Level-3-260C-168 HR
OPA4244EA/250	ACTIVE	TSSOP	PW	14	250	Pb-Free (RoHS)	CU NIPDAU	Level-3-260C-168 HR
OPA4244EA/2K5	ACTIVE	TSSOP	PW	14	2500	Pb-Free (RoHS)	CU NIPDAU	Level-3-260C-168 HR

⁽¹⁾ The marketing status values are defined as follows:

ACTIVE: Product device recommended for new designs.

LIFEBUY: TI has announced that the device will be discontinued, and a lifetime-buy period is in effect.

NRND: Not recommended for new designs. Device is in production to support existing customers, but TI does not recommend using this part in a new design.

PREVIEW: Device has been announced but is not in production. Samples may or may not be available.

OBsolete: TI has discontinued the production of the device.

⁽²⁾ Eco Plan - The planned eco-friendly classification: Pb-Free (RoHS), Pb-Free (RoHS Exempt), or Green (RoHS & no Sb/Br) - please check <http://www.ti.com/productcontent> for the latest availability information and additional product content details.

TBD: The Pb-Free/Green conversion plan has not been defined.

Pb-Free (RoHS): TI's terms "Lead-Free" or "Pb-Free" mean semiconductor products that are compatible with the current RoHS requirements for all 6 substances, including the requirement that lead not exceed 0.1% by weight in homogeneous materials. Where designed to be soldered at high temperatures, TI Pb-Free products are suitable for use in specified lead-free processes.

Pb-Free (RoHS Exempt): This component has a RoHS exemption for either 1) lead-based flip-chip solder bumps used between the die and package, or 2) lead-based die adhesive used between the die and leadframe. The component is otherwise considered Pb-Free (RoHS compatible) as defined above.

Green (RoHS & no Sb/Br): TI defines "Green" to mean Pb-Free (RoHS compatible), and free of Bromine (Br) and Antimony (Sb) based flame retardants (Br or Sb do not exceed 0.1% by weight in homogeneous material)

⁽³⁾ MSL, Peak Temp. -- The Moisture Sensitivity Level rating according to the JEDEC industry standard classifications, and peak solder

temperature.

Important Information and Disclaimer:The information provided on this page represents TI's knowledge and belief as of the date that it is provided. TI bases its knowledge and belief on information provided by third parties, and makes no representation or warranty as to the accuracy of such information. Efforts are underway to better integrate information from third parties. TI has taken and continues to take reasonable steps to provide representative and accurate information but may not have conducted destructive testing or chemical analysis on incoming materials and chemicals. TI and TI suppliers consider certain information to be proprietary, and thus CAS numbers and other limited information may not be available for release.

In no event shall TI's liability arising out of such information exceed the total purchase price of the TI part(s) at issue in this document sold by TI to Customer on an annual basis.

P (R-PDIP-T8)

PLASTIC DUAL-IN-LINE



- NOTES: A. All linear dimensions are in inches (millimeters).
 B. This drawing is subject to change without notice.
 C. Falls within JEDEC MS-001

For the latest package information, go to http://www.ti.com/sc/docs/package/pkg_info.htm



DBV (R-PDSO-G5)

PLASTIC SMALL-OUTLINE PACKAGE

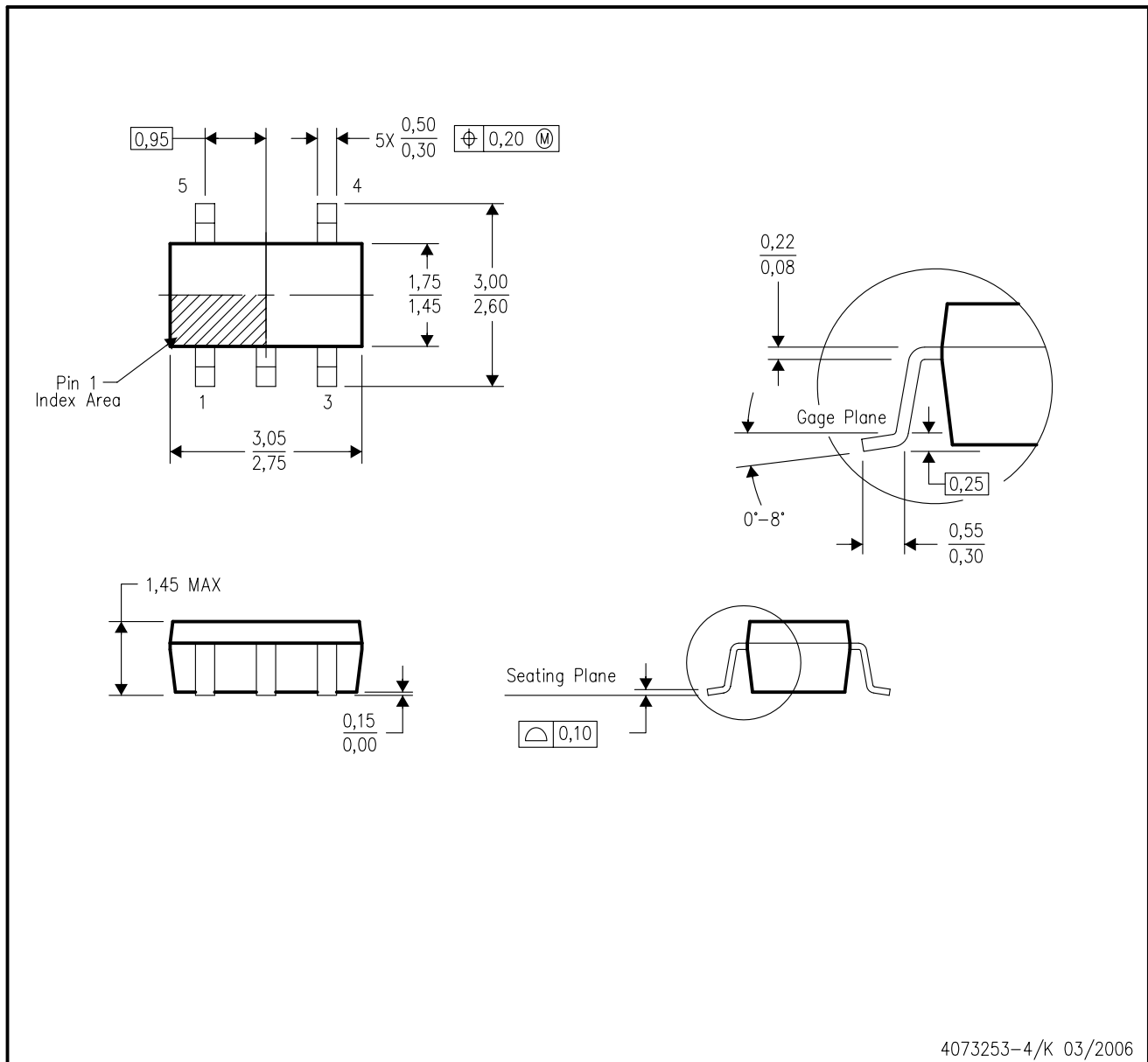

- NOTES:
- A. All linear dimensions are in millimeters.
 - B. This drawing is subject to change without notice.
 - C. Body dimensions do not include mold flash or protrusion. Mold flash and protrusion shall not exceed 0.15 per side.
 - D. Falls within JEDEC MO-178 Variation AA.

D (R-PDSO-G8)

PLASTIC SMALL-OUTLINE PACKAGE

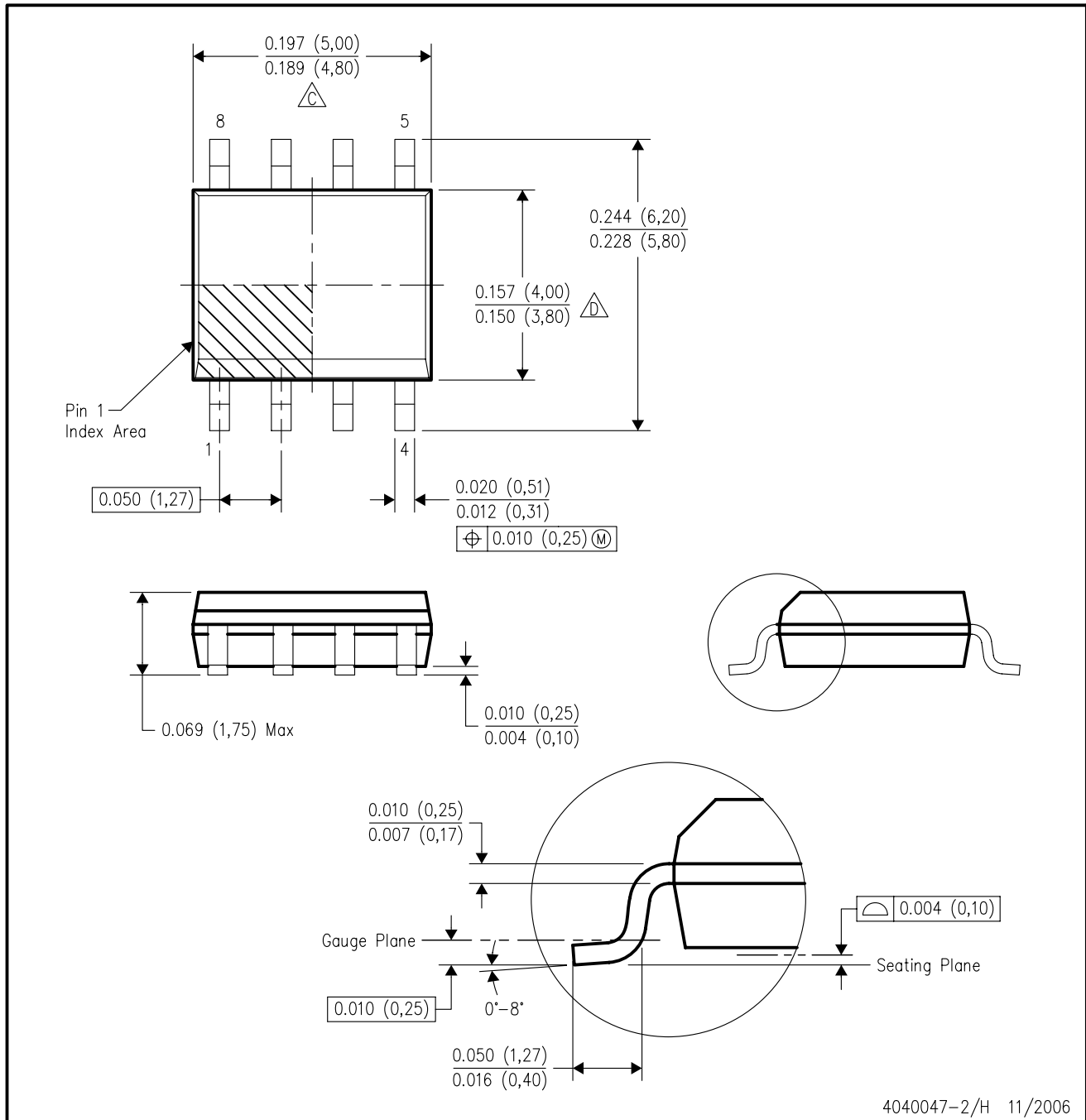

- NOTES:
- A. All linear dimensions are in inches (millimeters).
 - B. This drawing is subject to change without notice.
 - C. Body length does not include mold flash, protrusions, or gate burrs. Mold flash, protrusions, or gate burrs shall not exceed .006 (0,15) per end.
 - D. Body width does not include interlead flash. Interlead flash shall not exceed .017 (0,43) per side.
 - E. Reference JEDEC MS-012 variation AA.

PW (R-PDSO-G**)

PLASTIC SMALL-OUTLINE PACKAGE

14 PINS SHOWN



4040064/F 01/97

- NOTES: A. All linear dimensions are in millimeters.
 B. This drawing is subject to change without notice.
 C. Body dimensions do not include mold flash or protrusion not to exceed 0,15.
 D. Falls within JEDEC MO-153

IMPORTANT NOTICE

Texas Instruments Incorporated and its subsidiaries (TI) reserve the right to make corrections, modifications, enhancements, improvements, and other changes to its products and services at any time and to discontinue any product or service without notice. Customers should obtain the latest relevant information before placing orders and should verify that such information is current and complete. All products are sold subject to TI's terms and conditions of sale supplied at the time of order acknowledgment.

TI warrants performance of its hardware products to the specifications applicable at the time of sale in accordance with TI's standard warranty. Testing and other quality control techniques are used to the extent TI deems necessary to support this warranty. Except where mandated by government requirements, testing of all parameters of each product is not necessarily performed.

TI assumes no liability for applications assistance or customer product design. Customers are responsible for their products and applications using TI components. To minimize the risks associated with customer products and applications, customers should provide adequate design and operating safeguards.

TI does not warrant or represent that any license, either express or implied, is granted under any TI patent right, copyright, mask work right, or other TI intellectual property right relating to any combination, machine, or process in which TI products or services are used. Information published by TI regarding third-party products or services does not constitute a license from TI to use such products or services or a warranty or endorsement thereof. Use of such information may require a license from a third party under the patents or other intellectual property of the third party, or a license from TI under the patents or other intellectual property of TI.

Reproduction of information in TI data books or data sheets is permissible only if reproduction is without alteration and is accompanied by all associated warranties, conditions, limitations, and notices. Reproduction of this information with alteration is an unfair and deceptive business practice. TI is not responsible or liable for such altered documentation.

Resale of TI products or services with statements different from or beyond the parameters stated by TI for that product or service voids all express and any implied warranties for the associated TI product or service and is an unfair and deceptive business practice. TI is not responsible or liable for any such statements.

Following are URLs where you can obtain information on other Texas Instruments products and application solutions:

Products		Applications	
Amplifiers	amplifier.ti.com	Audio	www.ti.com/audio
Data Converters	dataconverter.ti.com	Automotive	www.ti.com/automotive
DSP	dsp.ti.com	Broadband	www.ti.com/broadband
Interface	interface.ti.com	Digital Control	www.ti.com/digitalcontrol
Logic	logic.ti.com	Military	www.ti.com/military
Power Mgmt	power.ti.com	Optical Networking	www.ti.com/opticalnetwork
Microcontrollers	microcontroller.ti.com	Security	www.ti.com/security
Low Power Wireless	www.ti.com/lpw	Telephony	www.ti.com/telephony
		Video & Imaging	www.ti.com/video
		Wireless	www.ti.com/wireless

Mailing Address: Texas Instruments
Post Office Box 655303 Dallas, Texas 75265