

IRF510SPbF

HEXFET® Power MOSFET

- Surface Mount
- Available in Tape & Reel
- Dynamic dv/dt Rating
- Repetitive Avalanche Rated
- 175°C Operating Temperature
- Fast Switching
- Ease of Paralleling
- Lead-Free

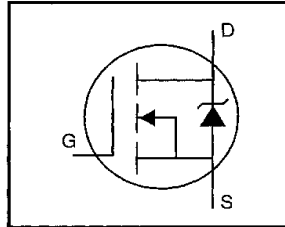

$$V_{DSS} = 100V$$

$$R_{DS(on)} = 0.54\Omega$$

$$I_D = 5.6A$$

Description

Third Generation HEXFETs from International Rectifier provide the designer with the best combination of fast switching, ruggedized device design, low on-resistance and cost-effectiveness.

The SMD-220 is a surface mount power package capable of accommodating die sizes up to HEX-4. It provides the highest power capability and the lowest possible on-resistance in any existing surface mount package. The SMD-220 is suitable for high current applications because of its low internal connection resistance and can dissipate up to 2.0W in a typical surface mount application.

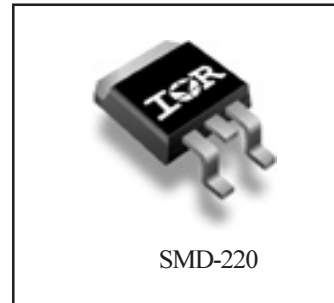

Absolute Maximum Ratings

	Parameter	Max.	Units
$I_D @ T_C = 25^\circ C$	Continuous Drain Current, $V_{GS} @ 10 V$	5.6	A
$I_D @ T_C = 100^\circ C$	Continuous Drain Current, $V_{GS} @ 10 V$	4.0	
I_{DM}	Pulsed Drain Current ①	20	
$P_D @ T_C = 25^\circ C$	Power Dissipation	43	W
$P_D @ T_A = 25^\circ C$	Power Dissipation (PCB Mount)**	3.7	
	Linear Derating Factor	0.29	
	Linear Derating Factor (PCB Mount)**	0.025	W/°C
V_{GS}	Gate-to-Source Voltage	± 20	V
E_{AS}	Single Pulse Avalanche Energy ②	100	mJ
I_{AR}	Avalanche Current ①	5.6	A
E_{AR}	Repetitive Avalanche Energy ①	4.3	mJ
dv/dt	Peak Diode Recovery dv/dt ③	5.5	V/ns
T_J, T_{STG}	Junction and Storage Temperature Range	-55 to +175	°C
	Soldering Temperature, for 10 seconds	300 (1.6mm from case)	

Thermal Resistance

	Parameter	Min.	Typ.	Max.	Units
$R_{\theta JC}$	Junction-to-Case	—	—	3.5	°C/W
$R_{\theta JA}$	Junction-to-Ambient (PCB mount)**	—	—	40	
$R_{\theta JA}$	Junction-to-Ambient	—	—	62	

** When mounted on 1" square PCB (FR-4 or G-10 Material).

For recommended footprint and soldering techniques refer to application note #AN-994.

Electrical Characteristics @ $T_J = 25^\circ\text{C}$ (unless otherwise specified)

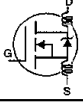
	Parameter	Min.	Typ.	Max.	Units	Test Conditions
$V_{(BR)DSS}$	Drain-to-Source Breakdown Voltage	100	—	—	V	$V_{GS}=0V, I_D=250\mu A$
$\Delta V_{(BR)DSS}/\Delta T_J$	Breakdown Voltage Temp. Coefficient	—	0.12	—	V/°C	Reference to 25°C , $I_D=1\text{mA}$
$R_{DS(on)}$	Static Drain-to-Source On-Resistance	—	—	0.54	Ω	$V_{GS}=10V, I_D=3.4A$ ③
$V_{GS(th)}$	Gate Threshold Voltage	2.0	—	4.0	V	$V_{DS}=V_{GS}, I_D=250\mu A$
g_{fs}	Forward Transconductance	1.3	—	—	S	$V_{DS}=50V, I_D=3.4A$ ③
I_{DSS}	Drain-to-Source Leakage Current	—	—	25	μA	$V_{DS}=100V, V_{GS}=0V$
		—	—	250		$V_{DS}=80V, V_{GS}=0V, T_J=150^\circ\text{C}$
I_{GSS}	Gate-to-Source Forward Leakage	—	—	100	nA	$V_{GS}=20V$
	Gate-to-Source Reverse Leakage	—	—	-100		$V_{GS}=-20V$
Q_g	Total Gate Charge	—	—	8.3	nC	$I_D=5.6A$
Q_{gs}	Gate-to-Source Charge	—	—	2.3		$V_{DS}=80V$
Q_{gd}	Gate-to-Drain ("Miller") Charge	—	—	3.8		$V_{GS}=10V$ See Fig. 6 and 13 ④
$t_{d(on)}$	Turn-On Delay Time	—	6.9	—	ns	$V_{DD}=50V$
t_r	Rise Time	—	16	—		$I_D=5.6A$
$t_{d(off)}$	Turn-Off Delay Time	—	15	—		$R_G=24\Omega$
t_f	Fall Time	—	9.4	—		$R_D=8.4\Omega$ See Figure 10 ④
L_D	Internal Drain Inductance	—	4.5	—	nH	Between lead, 6 mm (0.25in.) from package and center of die contact 
L_S	Internal Source Inductance	—	7.5	—		
C_{iss}	Input Capacitance	—	180	—	pF	$V_{GS}=0V$
C_{oss}	Output Capacitance	—	81	—		$V_{DS}=25V$
C_{rss}	Reverse Transfer Capacitance	—	15	—		$f=1.0\text{MHz}$ See Figure 5

Source-Drain Ratings and Characteristics

	Parameter	Min.	Typ.	Max.	Units	Test Conditions
I_S	Continuous Source Current (Body Diode)	—	—	5.6	A	MOSFET symbol showing the integral reverse p-n junction diode. 
I_{SM}	Pulsed Source Current (Body Diode) ①	—	—	20		
V_{SD}	Diode Forward Voltage	—	—	2.5	V	$T_J=25^\circ\text{C}, I_S=5.6A, V_{GS}=0V$ ④
t_{rr}	Reverse Recovery Time	—	100	200	ns	$T_J=25^\circ\text{C}, I_F=5.6A$
Q_{rr}	Reverse Recovery Charge	—	0.44	0.88	μC	$di/dt=100A/\mu s$ ④
t_{on}	Forward Turn-On Time	Intrinsic turn-on time is negligible (turn-on is dominated by L_S+L_D)				

Notes:

- ① Repetitive rating; pulse width limited by max. junction temperature (See Figure 11)
- ② $V_{DD}=25V$, starting $T_J=25^\circ\text{C}$, $L=4.8\text{mH}$, $R_G=25\Omega$, $I_{AS}=5.6A$ (See Figure 12)
- ③ $I_{SD}\leq 5.6A$, $di/dt\leq 75A/\mu s$, $V_{DD}\leq V_{(BR)DSS}$, $T_J\leq 175^\circ\text{C}$
- ④ Pulse width $\leq 300\mu s$; duty cycle $\leq 2\%$.

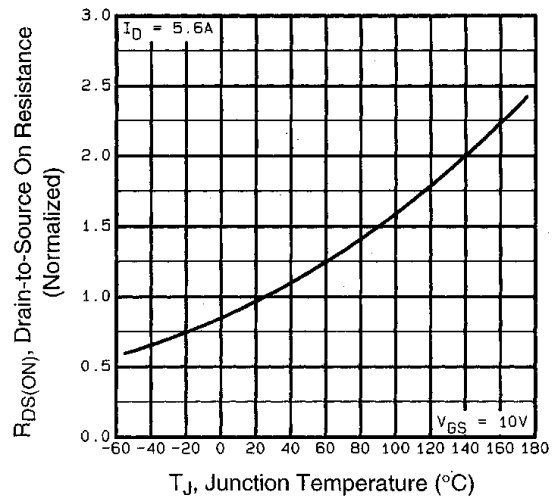
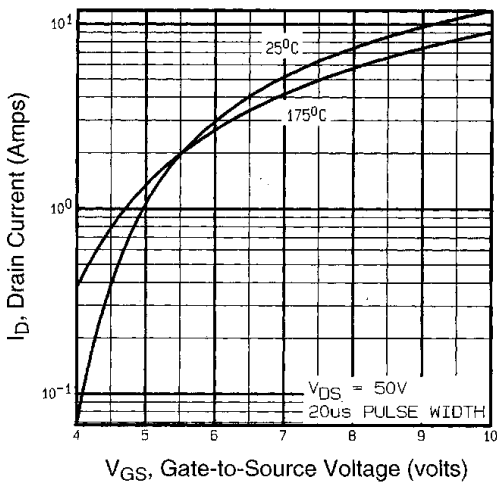
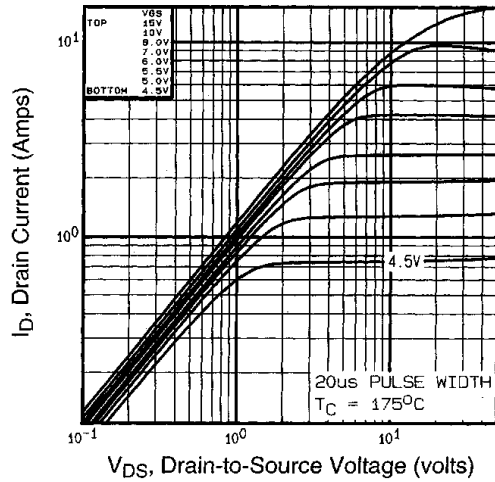
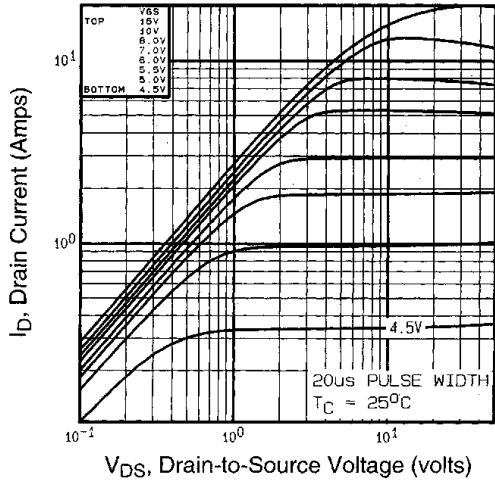

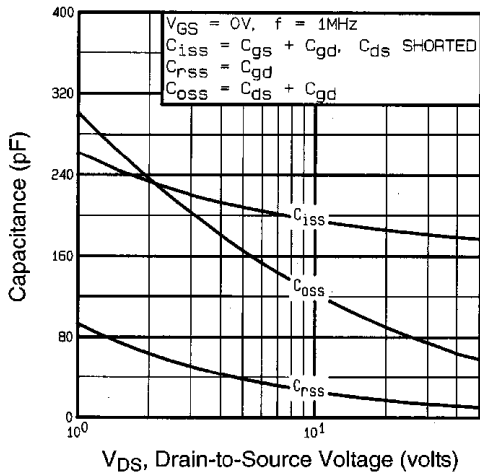

Fig 5. Typical Capacitance Vs. Drain-to-Source Voltage

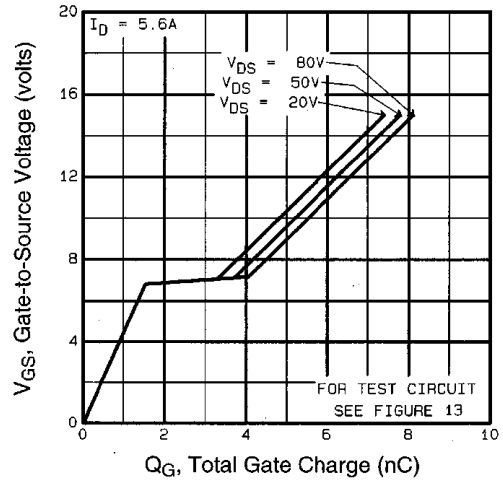

Fig 6. Typical Gate Charge Vs. Gate-to-Source Voltage

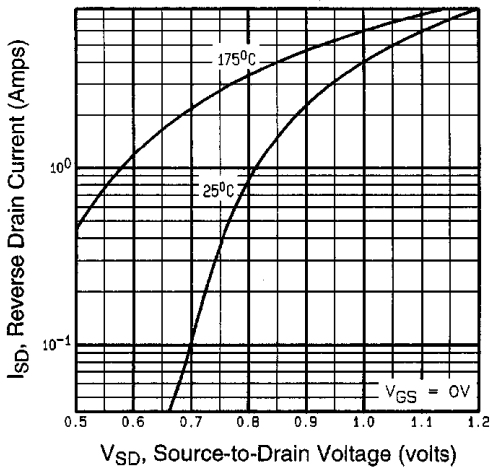

Fig 7. Typical Source-Drain Diode Forward Voltage

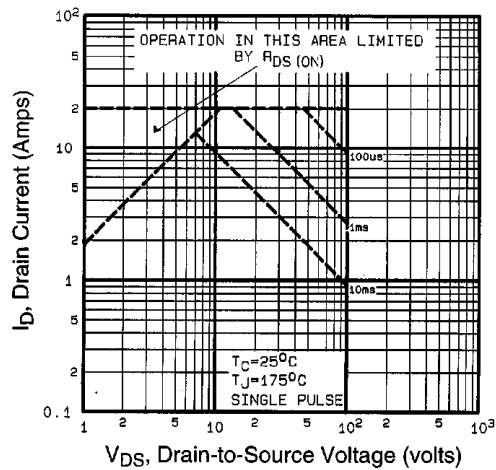

Fig 8. Maximum Safe Operating Area

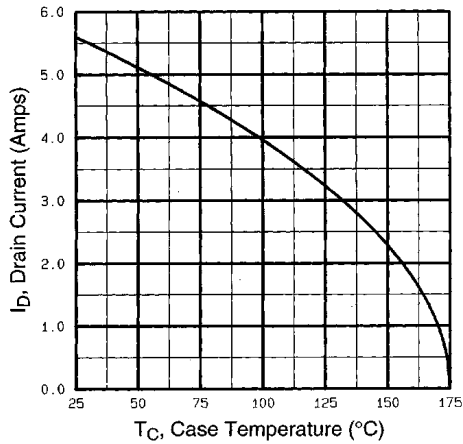

Fig 9. Maximum Drain Current Vs. Case Temperature

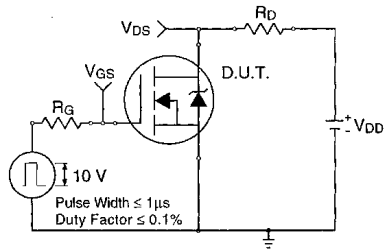

Fig 10a. Switching Time Test Circuit

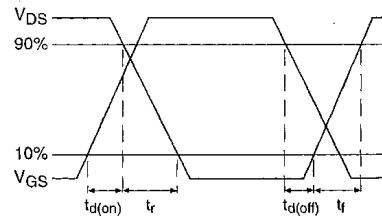

Fig 10b. Switching Time Waveforms

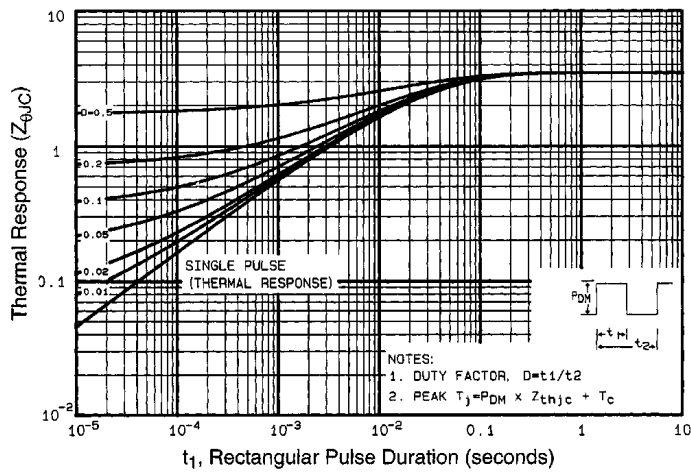

Fig 11. Maximum Effective Transient Thermal Impedance, Junction-to-Case

IRF510SPbF

International
IR Rectifier

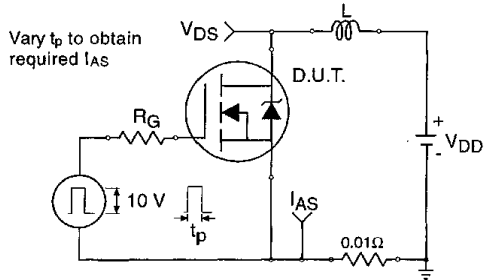

Fig 12a. Unclamped Inductive Test Circuit

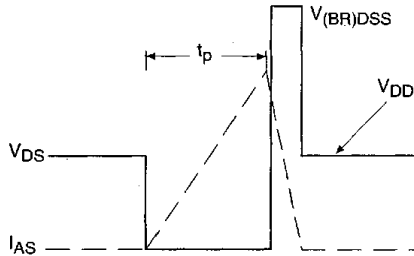

Fig 12b. Unclamped Inductive Waveforms

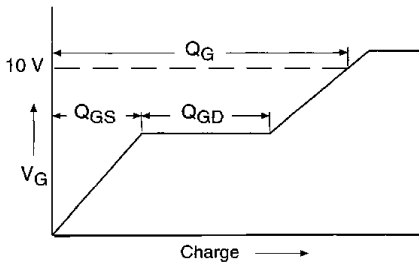

Fig 13a. Basic Gate Charge Waveform

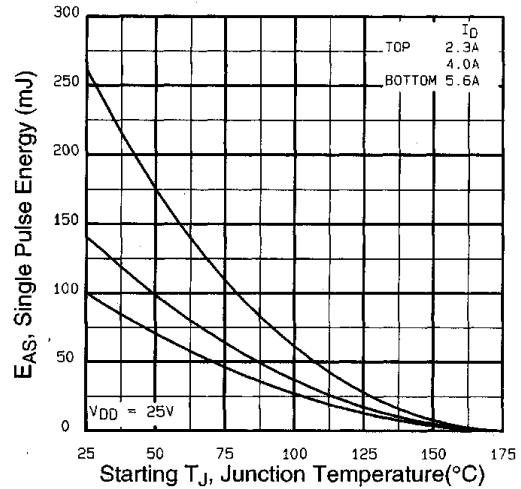

Fig 12c. Maximum Avalanche Energy Vs. Drain Current

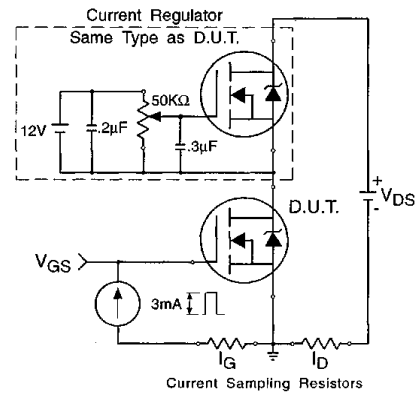
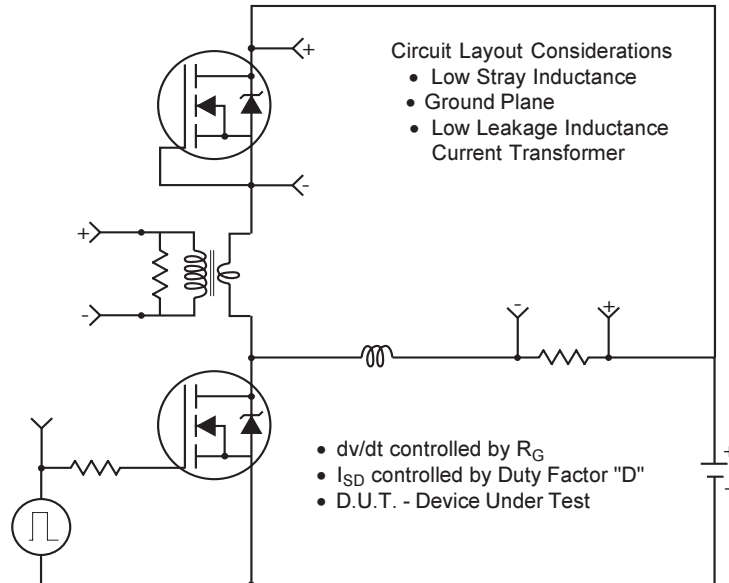

Fig 13b. Gate Charge Test Circuit

Peak Diode Recovery dv/dt Test Circuit



* Reverse Polarity for P-Channel

** Use P-Channel Driver for P-Channel Measurements

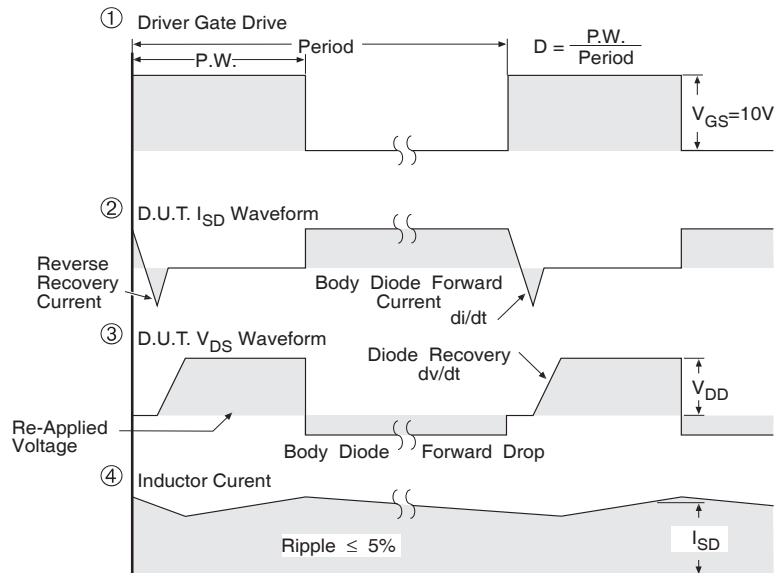

*** $V_{GS} = 5.0V$ for Logic Level and 3V Drive Devices

Fig. 14 For N and P Channel HEXFETS

IRF510SPbF

International
IR Rectifier

D²Pak Package Outline

Dimensions are shown in millimeters (inches)

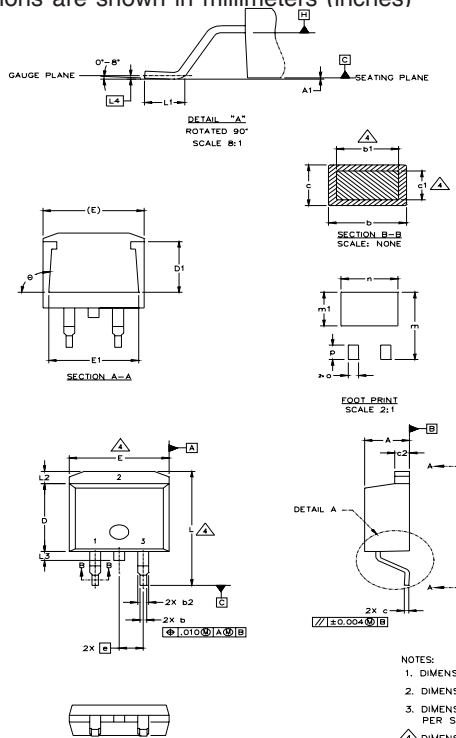

SYMBOL	DIMENSIONS				NOTES
	MILLIMETERS		INCHES		
	MIN.	MAX.	MIN.	MAX.	
A	4.06	4.83	.160	.190	4
A1		0.127		.005	
b	0.51	0.99	.020	.039	
b1	0.51	0.89	.020	.035	4
b2	1.14	1.40	.045	.055	
c	0.43	0.63	.017	.025	
c1	0.38	0.74	.015	.029	3
c2	1.14	1.40	.045	.055	
D	8.51	9.65	.335	.380	
D1	5.33		.210		3
E	9.65	10.67	.380	.420	
E1	6.22		.245		
e	2.54 BSC		.100 BSC		
L	14.61	15.88	.575	.625	
L1	1.78	2.79	.070	.110	
L2		1.65		.065	
L3	1.27	1.78	.050	.070	
L4	0.25 BSC		.010 BSC		
m	17.78		.700		
m1	8.89		.350		
n	11.43		.450		
o	2.08		.082		
p	3.81		.150		
theta	90°		90°		

LEAD ASSIGNMENTS

HEXFET	IGBTs, CoPACK	DIODES
1.- GATE	1.- GATE	1.- ANODE *
2.- DRAIN	2.- COLLECTOR	2.- CATHODE
3.- SOURCE	3.- EMITTER	3.- ANODE

* PART DEPENDENT.

- NOTES:
1. DIMENSIONING AND TOLERANCING PER ASME Y14.5M-1994
 2. DIMENSIONS ARE SHOWN IN MILLIMETERS [INCHES].
 3. DIMENSION D & E DO NOT INCLUDE MOLD FLASH. MOLD FLASH SHALL NOT EXCEED 0.127 [0.005"] PER SIDE. THESE DIMENSIONS ARE MEASURED AT THE OUTMOST EXTREMES OF THE PLASTIC BODY.
 4. DIMENSION b1 AND c1 APPLY TO BASE METAL ONLY.
 5. CONTROLLING DIMENSION: INCH.

D²Pak Part Marking Information (Lead-Free)

EXAMPLE: THIS IS AN IRF530S WITH
LOT CODE 8024
ASSEMBLED ON WW 02, 2000
IN THE ASSEMBLY LINE "L"

Note: "P" in assembly line
position indicates "Lead-Free"

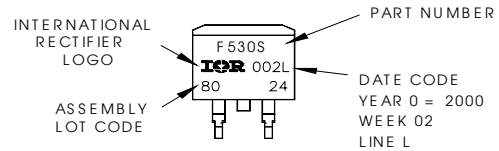

OR

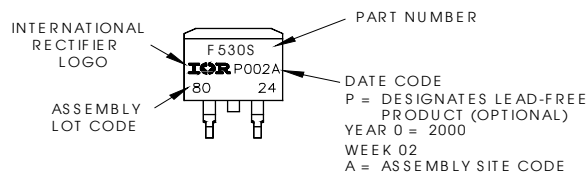

D²Pak Tape & Reel Information

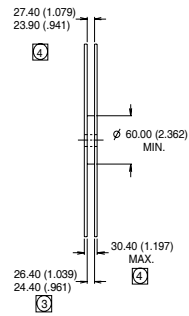
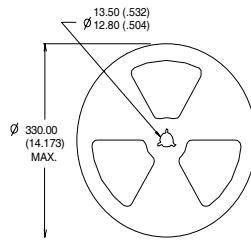
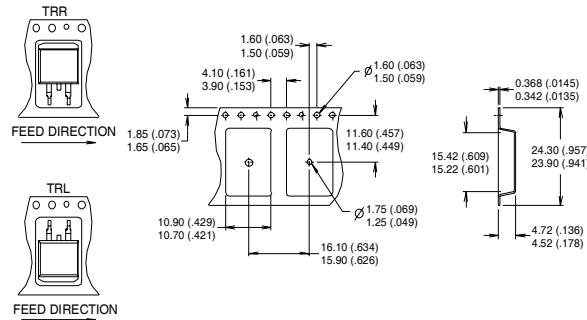

- NOTES:
1. COMFORMS TO EIA-418.
 2. CONTROLLING DIMENSION: MILLIMETER.
 - ④ DIMENSION MEASURED @ HUB.
 - ③ INCLUDES FLANGE DISTORTION @ OUTER EDGE.

Data and specifications subject to change without notice.

International
IR Rectifier

IR WORLD HEADQUARTERS: 233 Kansas St., El Segundo, California 90245, USA Tel: (310) 252-7105
 TAC Fax: (310) 252-7903

Visit us at www.irf.com for sales contact information.07/04