

MODEL NO. & SELECTION GUIDE:

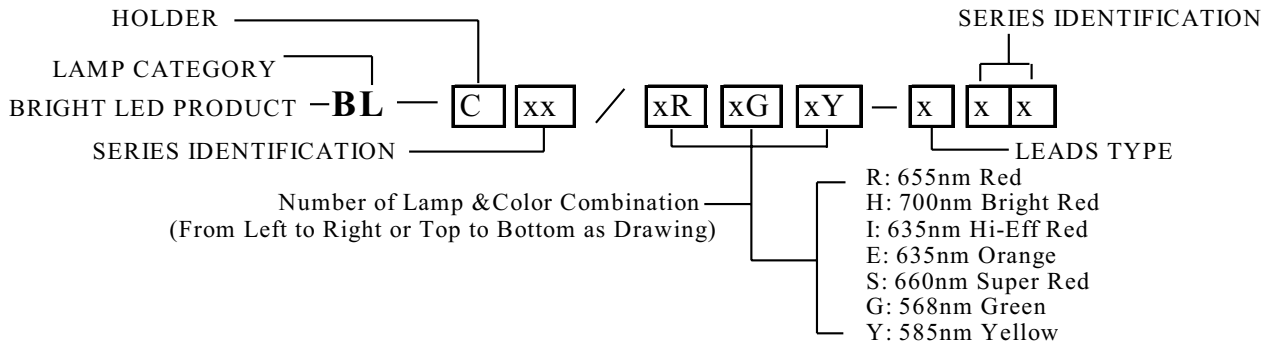
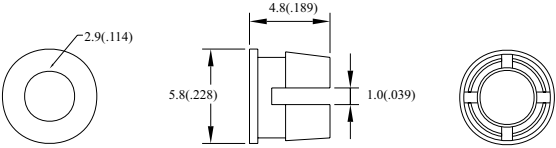
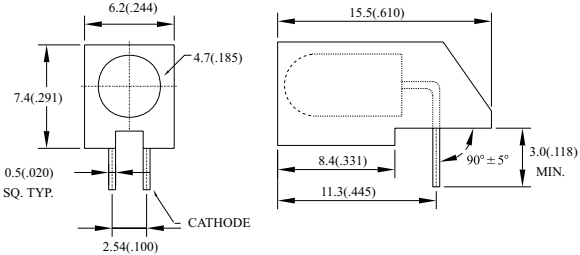
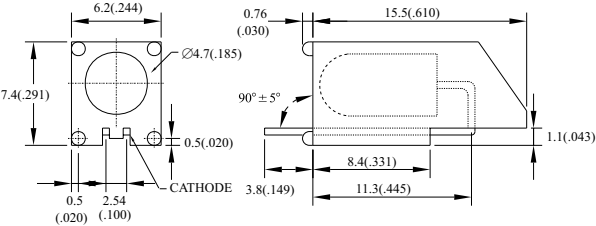
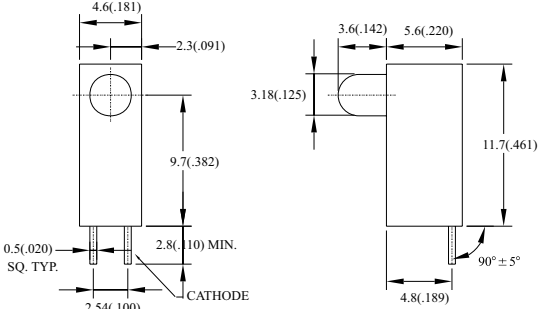
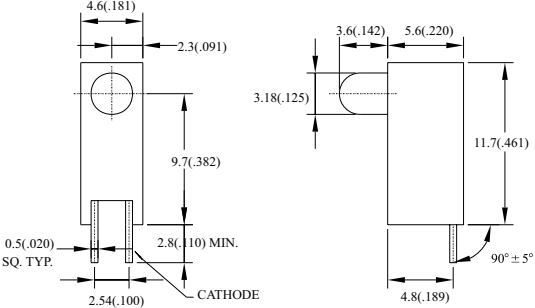
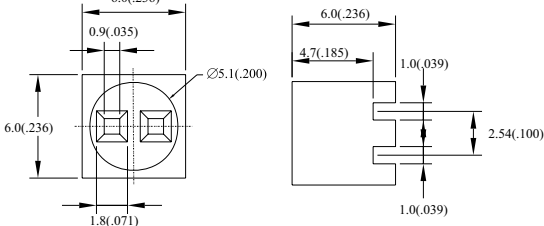

H-01 BL-C1 (3) Series	H-02 BL-C13A/xx-37N Series
	
H-03 BL-C13C/xx37N Series	H-04 BL-C15A/xx-31H Series
	
H-05 BL-C15B/xx-31H Series	H-06 BL-C16 Series
	

Notes : 1.All Dimensions are in millimeters (inches).
2.Tolerance is $\pm 0.25\text{mm}$ (.010").