

Hex Buffers/Logic-Level Down Converters

High-Performance Silicon-Gate CMOS

The MC54/74HC4049 consists of six inverting buffers, and the MC54/74HC4050 consists of six noninverting buffers. They are identical in pinout to the MC14049UB and MC14050B metal-gate CMOS buffers. The device inputs are compatible with standard CMOS outputs; with pullup resistors, they are compatible with LSTTL outputs.

The input protection circuitry on these devices has been modified by eliminating the V_{CC} diodes to allow the use of input voltages up to 15 volts. Thus, the devices may be used as logic-level translators that convert from a high voltage to a low voltage while operating at the low-voltage power supply. They allow MC14000-series CMOS operating up to 15 volts to be interfaced with High-Speed CMOS at 2 to 6 volts. The protection diodes to GND are Zener diodes, which protect the inputs from both positive and negative voltage transients.

- Output Drive Capability: 10 LSTTL Loads
- Outputs Directly Interface to CMOS, NMOS, and TTL
- Operating Voltage Range: 2 to 6 V
- Low Input Current: 5 μ A
- High Noise Immunity Characteristic of CMOS Devices
- In Compliance with the Requirements Defined by JEDEC Standard No. 7A
- Chip Complexity: 36 FETs or 9 Equivalent Gates (4049)
24 FETs or 6 Equivalent Gates (4050)

LOGIC DIAGRAMS

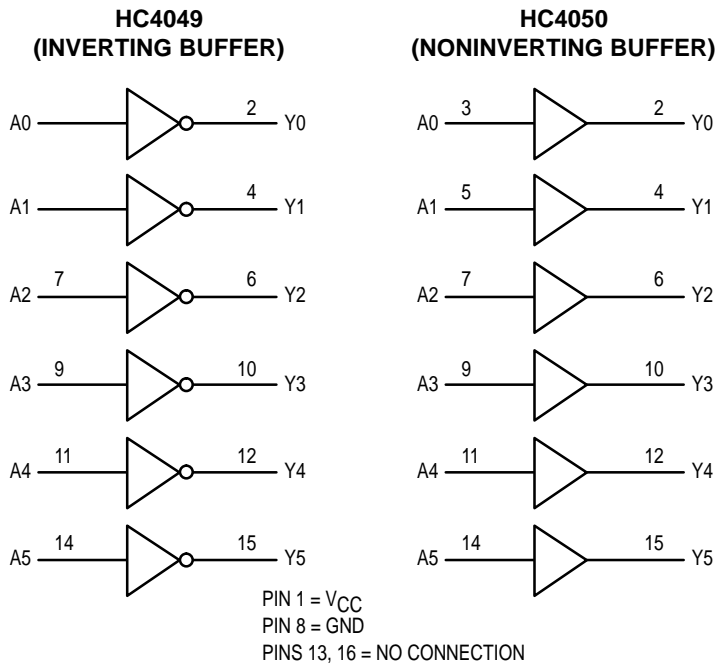

MC54/74HC4049 MC54/74HC4050

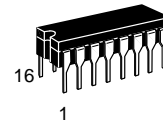

J SUFFIX
CERAMIC PACKAGE
CASE 620-10

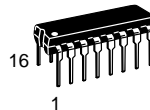

N SUFFIX
PLASTIC PACKAGE
CASE 648-08

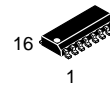

D SUFFIX
SOIC PACKAGE
CASE 751B-05

ORDERING INFORMATION

MC54HCXXXXJ	Ceramic
MC74HCXXXXN	Plastic
MC74HCXXXXD	SOIC

PIN ASSIGNMENT

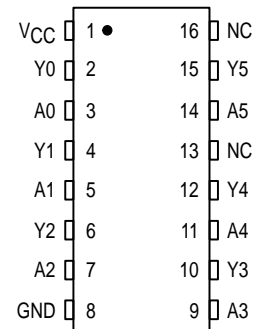

NC = NO CONNECTION

FUNCTION TABLE

A Input	Y Outputs	
	HC4049	HC4050
L	H	L
H	L	H



MC54/74HC4049 MC54/74HC4050

MAXIMUM RATINGS*

Symbol	Parameter	Value	Unit
V _{CC}	DC Supply Voltage (Referenced to GND)	- 0.5 to + 7.0	V
V _{in}	DC Input Voltage (Referenced to GND)	- 1.5 to + 18	V
V _{out}	DC Output Voltage (Referenced to GND)	- 0.5 to V _{CC} + 0.5	V
I _{in}	DC Input Current, per Pin	± 20	mA
I _{out}	DC Output Current, per Pin	± 25	mA
I _{CC}	DC Supply Current, V _{CC} and GND Pins	± 50	mA
P _D	Power Dissipation in Still Air, Plastic or Ceramic DIP† SOIC Package†	750 500	mW
T _{stg}	Storage Temperature	- 65 to + 150	°C
T _L	Lead Temperature, 1 mm from Case for 10 Seconds (Plastic DIP or SOIC Package) (Ceramic DIP)	260 300	°C

This device contains circuitry to protect the inputs against damage due to high static voltages or electric fields referenced to the GND pin, only. Extra precautions must be taken to avoid applications of any voltage higher than maximum rated voltages to this high-impedance circuit. For proper operation, the ranges $GND \leq V_{in} \leq 15\text{ V}$ and $GND \leq V_{out} \leq V_{CC}$ are recommended.

Unused inputs must always be tied to an appropriate logic voltage level (e.g., either GND or V_{CC}).

* Maximum Ratings are those values beyond which damage to the device may occur. Functional operation should be restricted to the Recommended Operating Conditions.

† Derating — Plastic DIP: - 10 mW/°C from 65° to 125°C
Ceramic DIP: - 10 mW/°C from 100° to 125°C
SOIC Package: - 7 mW/°C from 65° to 125°C

For high frequency or heavy load considerations, see Chapter 2 of the Motorola High-Speed CMOS Data Book (DL129/D).

RECOMMENDED OPERATING CONDITIONS

Symbol	Parameter	Min	Max	Unit	
V _{CC}	DC Supply Voltage (Referenced to GND)	2.0	6.0	V	
V _{in}	DC Input Voltage (Referenced to GND)	0	V _{CC} to 15	V	
V _{out}	DC Output Voltage (Referenced to GND)	0	V _{CC}	V	
T _A	Operating Temperature, All Package Types	- 55	+ 125	°C	
t _r , t _f	Input Rise and Fall Time (Figure 1)	V _{CC} = 2.0 V V _{CC} = 4.5 V V _{CC} = 6.0 V	0 0 0	1000 500 400	ns

DC ELECTRICAL CHARACTERISTICS (Voltages Referenced to GND)

Symbol	Parameter	Test Conditions	V _{CC} V	Guaranteed Limit			Unit
				- 55 to 25°C	≤ 85°C	≤ 125°C	
V _{IH}	Minimum High-Level Input Voltage	V _{out} = V _{CC} - 0.1 V I _{out} ≤ 20 μA	2.0	1.5	1.5	1.5	V
			4.5	3.15	3.15	3.15	
			6.0	4.2	4.2	4.2	
V _{IL}	Maximum Low-Level Input Voltage	V _{out} = 0.1 V or V _{CC} - 0.1 V I _{out} ≤ 20 μA	2.0	0.3	0.3	0.3	V
			4.5	0.9	0.9	0.9	
			6.0	1.2	1.2	1.2	
V _{OH}	Minimum High-Level Output Voltage	V _{in} = V _{IH} I _{out} ≤ 20 μA	2.0	1.9	1.9	1.9	V
			4.5	4.4	4.4	4.4	
			6.0	5.9	5.9	5.9	
			V _{in} = V _{IH} or V _{IL} I _{out} ≤ 4.0 mA I _{out} ≤ 5.2 mA	4.5	3.98	3.84	
V _{OL}	Maximum Low-Level Output Voltage	V _{in} = V _{IH} or V _{IL} I _{out} ≤ 20 μA	2.0	0.1	0.1	0.1	V
			4.5	0.1	0.1	0.1	
			6.0	0.1	0.1	0.1	
			V _{in} = V _{IH} or V _{IL} I _{out} ≤ 4.0 mA I _{out} ≤ 5.2 mA	4.5	0.26	0.33	
I _{in}	Maximum Input Leakage Current	V _{in} = V _{CC} or GND V _{in} = 15 V	6.0	± 0.1	± 1.0	± 1.0	μA
			6.0	0.5	5.0	5.0	
I _{CC}	Maximum Quiescent Supply Current (per Package)	V _{in} = 15 V or GND I _{out} = 0 μA	6.0	2	20	40	μA

NOTE: Information on typical parametric values can be found in Chapter 2 of the Motorola High-Speed CMOS Data Book (DL129/D).

AC ELECTRICAL CHARACTERISTICS ($C_L = 50 \text{ pF}$, Input $t_r = t_f = 6 \text{ ns}$)

Symbol	Parameter	VCC V	Guaranteed Limit			Unit
			- 55 to 25°C	≤ 85°C	≤ 125°C	
t _{PLH} , t _{PHL}	Maximum Propagation Delay, Input A to Output Y (Figures 1 and 2)	2.0	85	105	130	ns
		4.5	17	21	26	
		6.0	14	18	22	
t _{TLH} , t _{THL}	Maximum Output Transition Time, Any Output (Figures 1 and 2)	2.0	75	95	110	ns
		4.5	15	19	22	
		6.0	13	16	19	
C _{in}	Maximum Input Capacitance		10	10	10	pF

NOTES:

1. For propagation delays with loads other than 50 pF, see Chapter 2 of the Motorola High-Speed CMOS Data Book (DL129/D).
2. Information on typical parametric values can be found in Chapter 2 of the Motorola High-Speed CMOS Data Book (DL129/D).

C _{PD}	Power Dissipation Capacitance (Per Buffer)*	Typical @ 25°C, VCC = 5.0 V	pF
		27	

* Used to determine the no-load dynamic power consumption: $P_D = C_{PD} V_{CC}^2 f + I_{CC} V_{CC}$. For load considerations, see Chapter 2 of the Motorola High-Speed CMOS Data Book (DL129/D).

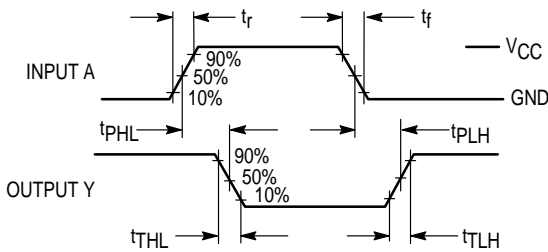

Figure 1a. Switching Waveforms (HC4049)

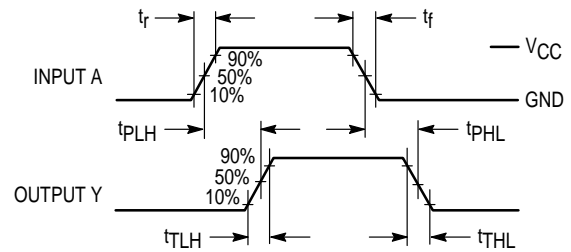
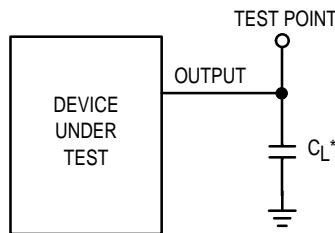

Figure 1b. Switching Waveforms (HC4050)



* Includes all probe and jig capacitance

Figure 2. Test Circuit

LOGIC DETAIL

**HC4049
(1/6 of the Device)**

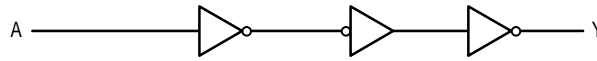

**HC4050
(1/6 of the Device)**

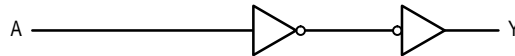

TYPICAL APPLICATIONS

LSTTL to Low-Voltage HSCMOS

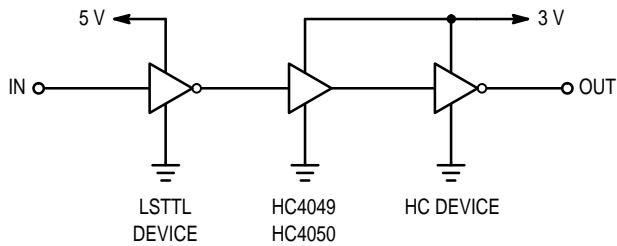

High-Voltage CMOS to HSCMOS

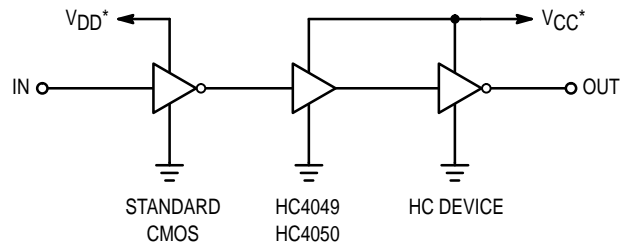

NOTE: To determine the noise immunity for the LSTTL to low-voltage configuration, use Eq. 1 and Eq. 2:

(TTL) V_{OH} - (CMOS) V_{IH} Eq. 1

(TTL) V_{OL} - (CMOS) V_{IL} Eq. 2

For the supply levels shown:

$2.4 - 3 (75\%) = 2.4 - 2.25 = 0.15 \text{ V}$

$0.4 - 3 (15\%) = 0.4 - 0.45 = 0.05 \text{ V}$

Therefore, worst case noise immunity is 50 mV.

For supply levels greater than 4.5 volts use the 74HCT04A for direct interface to TTL outputs.

***Table 1. Supply Examples**

V_{DD}	V_{CC}
15 V	2 V
12 V	5 V
12 V	3 V

Motorola reserves the right to make changes without further notice to any products herein. Motorola makes no warranty, representation or guarantee regarding the suitability of its products for any particular purpose, nor does Motorola assume any liability arising out of the application or use of any product or circuit, and specifically disclaims any and all liability, including without limitation consequential or incidental damages. "Typical" parameters can and do vary in different applications. All operating parameters, including "Typicals" must be validated for each customer application by customer's technical experts. Motorola does not convey any license under its patent rights nor the rights of others. Motorola products are not designed, intended, or authorized for use as components in systems intended for surgical implant into the body, or other applications intended to support or sustain life, or for any other application in which the failure of the Motorola product could create a situation where personal injury or death may occur. Should Buyer purchase or use Motorola products for any such unintended or unauthorized application, Buyer shall indemnify and hold Motorola and its officers, employees, subsidiaries, affiliates, and distributors harmless against all claims, costs, damages, and expenses, and reasonable attorney fees arising out of, directly or indirectly, any claim of personal injury or death associated with such unintended or unauthorized use, even if such claim alleges that Motorola was negligent regarding the design or manufacture of the part. Motorola and  are registered trademarks of Motorola, Inc. Motorola, Inc. is an Equal Opportunity/Affirmative Action Employer.

How to reach us:

USA/EUROPE: Motorola Literature Distribution;
P.O. Box 20912; Phoenix, Arizona 85036. 1-800-441-2447

MFAX: RMFAX0@email.sps.mot.com -TOUCHTONE (602) 244-6609
INTERNET: <http://Design-NET.com>

JAPAN: Nippon Motorola Ltd.; Tatsumi-SPD-JLDC, Toshikatsu Otsuki,
6F Seibu-Butsuryu-Center, 3-14-2 Tatsumi Koto-Ku, Tokyo 135, Japan. 03-3521-8315

HONG KONG: Motorola Semiconductors H.K. Ltd.; 8B Tai Ping Industrial Park,
51 Ting Kok Road, Tai Po, N.T., Hong Kong. 852-26629298



◇ CODELINE

MC54/74HC4049/D

