

3532 / 3132

SMT Stiftheisen - RM 2,54 mm - stehend - Präzisionskontakte

SMT Header - Pitch 2,54 mm - Vertical Type - Precision Contacts

Technische Daten / Technical Data

Isolierkörper	High-Temp. Polyester, nach UL94V0
Insulator	High-Temp. Polyester, rated UL94V0
Kontakt	Vierkantstift □ 0,635 mm, CuZn30, thermisch gerissen
Contact	Square Pin □ 0,635 mm, CuZn30, thermal striceted
Kontaktoberfläche	lt. Oberflächenoptionen, über 2,5 µm Ni
Contact Surface	acc. to options (see below) over 2,5 µm Ni
Durchgangswiderstand	≤ 20 mOhm
Transition Resistance	
Isolationswiderstand	> 10 ⁹ Ohm
Insulation Resistance	
Betriebsspannung	250 V _{AC}
Operating Voltage	
Spannungsfestigkeit	1000 V _{eff.}
Test Voltage	
Nennstrom	3 A
Current Rating	
Temperaturbereich	-55°C ... +125°C
Temperature Range	
Verarbeitungstemperatur	230°C für max. 60 s, 260°C für max. 10 s
Processing Temperature	230°C for max. 60 s, 260°C for max. 10 s

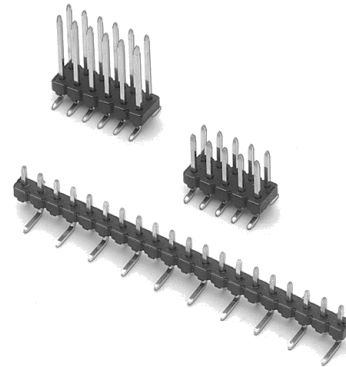

© W+P PRODUCTS

Passende Buchsenleisten Serie:
Mates with Female Headers Series:
3490 / 3491 / 1531 / 1532

Series 3532

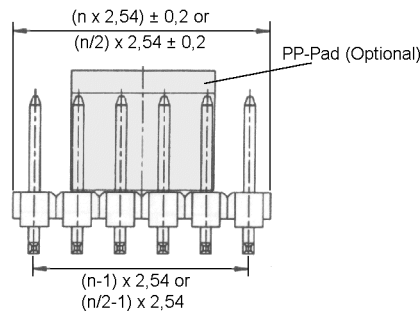
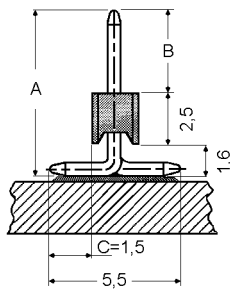

Series 3132

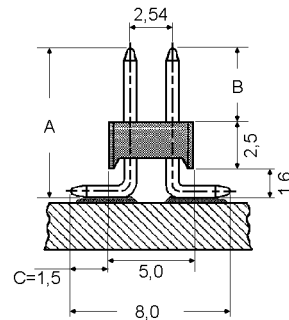

n = Anzahl der Kontakte
n = No. of Contacts

Layout B1

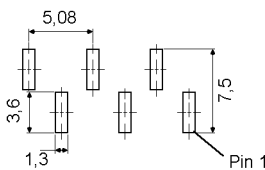

Layout B2

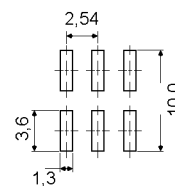
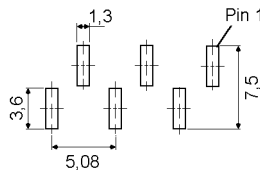

Series	Dimensions*	Contacts*	Plating*	Layout*	Packing*
3532	13	010	00	1	PPTR
3532 einreihig single row	12 = A/B/C : 9,4 / 5,3 / 1,5 13 = A/B/C : 10,7 / 6,6 / 1,5	003-050-pol. einreihig single row	00 = vergoldet gold plated	0 = für Serie 3132 for Series 3132	00 ST
3132 zweireihig double row	14 = A/B/C : 12,0 / 7,9 / 1,5 15 = A/B/C : 12,9 / 8,8 / 1,5 16 = A/B/C : 15,8 / 11,7 / 1,5 17 = A/B/C : 17,9 / 13,8 / 1,5 18 = A/B/C : 19,7 / 15,6 / 1,5 19 = A/B/C : 20,9 / 16,8 / 1,5 20 = A/B/C : 23,0 / 18,9 / 1,5	004-100-pol. zweireihig double row	10 = 0,25 µm Gold 0,25 µm gold plated 50 = verzinkt tin plated	1 = Layout B1 für Serie 3532 Layout B1 for Series 3532 2 = Layout B2 für Serie 3532 Layout B2 for Series 3532	PPST PPTR

Weitere Stiftlängen und Oberflächenveredelungen auf Anfrage.
Other contact lengths and plating options upon request.

(* Bestellbeispiel - Bitte durch Ihre Spezifikationen ersetzen.
* Order example - To be replaced by your specifications.)

Lieferformen / Packing Options:

00 = Schüttgut ohne PP-Pad / bulk goods w/o PP-Pad

ST = verpackt in Stangen / packed in tubes

PPST = in Stangen mit PP-Pad / in tubes w/ PP-Pad

PPTR = mit PP-Pad, Tape & Reel Verpackung / Tape & Reel Packing w/ PP-Pad

TEL.: +49 5223 98507-0
FAX : +49 5223 98507-50

W+P PRODUCTS

E-MAIL: sales@wpro.com
INTERNET: www.wpro.com