

ER2A THRU ER2J

SURFACE MOUNT SUPERFAST RECTIFIER
VOLTAGE - 50 - 600 Volts CURRENT - 2.0 Amperes

FEATURES

- For surface mounted applications
- Low profile package
- Built-in strain relief
- Easy pick and place
- Superfast recovery times for high efficiency
- Plastic package has Underwriters Laboratory Flammability Classification 94V-0
- Glass passivated junction
- High temperature soldering:
280°C/10 seconds at terminals

MECHANICAL DATA

Case: JEDEC DO-214AA molded plastic
 Terminals: Solder plated solderable per MIL-STD-750, Method 2028
 Polarity: Indicated by cathode band
 Standard Packaging: 12mm tape (EIA-481)
 Weight: 0.003 ounces, 0.093 gram

SMB/DO-214AA

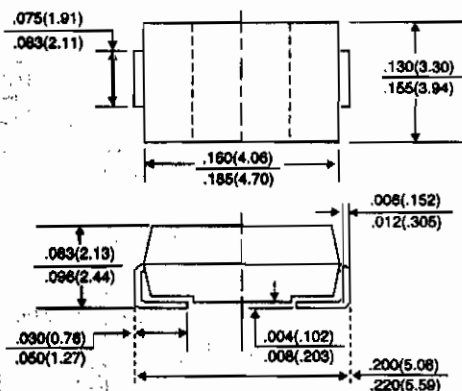

Dimensions in inches and (millimeters)

MAXIMUM RATINGS AND ELECTRICAL CHARACTERISTICS

Ratings at 25°C ambient temperature unless otherwise specified.
 Single phase, half wave, 60 Hz, resistive or inductive load.
 For capacitive load, derate current by 20%.

	SYMBOLS	ER2A	ER2B	ER2C	ER2D	ER2E	ER2G	ER2J	UNITS
Maximum Recurrent Peak Reverse Voltage	V _{RRM}	50	100	150	200	300	400	600	Volts
Maximum RMS Voltage	V _{RMS}	35	70	105	140	210	280	420	Volts
Maximum DC Blocking Voltage	V _{DC}	50	100	150	200	300	400	600	Volts
Maximum Average Forward Rectified Current, at T _L = 110°C	I _{AV}	2.0							Amps
Peak Forward Surge Current 8.3ms single half sine-wave superimposed on rated load (JEDEC Method)	I _{FSM}	50.0							Amps
Maximum Instantaneous Forward Voltage at 2.0A	V _F	0.95			1.25		1.7		Volts
Maximum DC Reverse Current at Rated DC Blocking Voltage T _A = 25°C T _A = 100°C	I _R	5.0			100				μA
Maximum Reverse Recovery Time (NOTE 1)	T _{RR}	35.0							Ns
Typical Junction Capacitance (NOTE 2)	C _J	25.0							pf
Typical Thermal Resistance (NOTE 3)	R _{θJL}	20.0							°C/W
Operating and Storage Temperature Range	T _J , T _{STG}	-50 to +150							°C

NOTES:

1. Reverse Recovery Test Conditions: I_F = 0.5A, I_R = 1.0A, I_{rr} = 0.25A.
2. Measured at 1.0 MHz and applied reverse voltage of 4.0 volts.
3. 8.0mm² (.013mm thick) land areas.

**RATING AND CHARACTERISTIC CURVES
ER2A THRU ER2J**

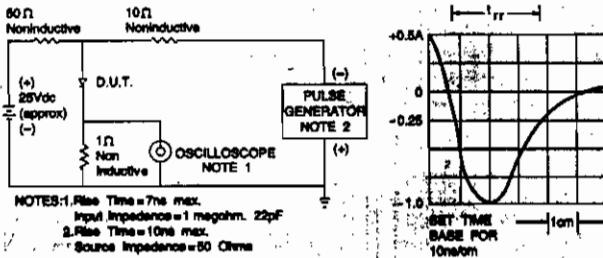

FIG. 1 - REVERSE RECOVERY TIME CHARACTERISTIC AND TEST DIAGRAM

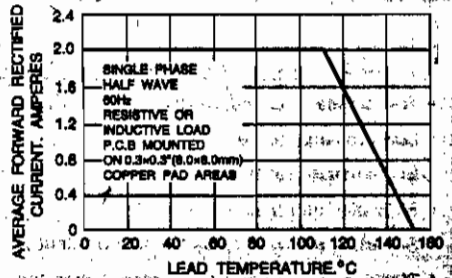

FIG. 2 - MAXIMUM AVERAGE FORWARD CURRENT RATINGS

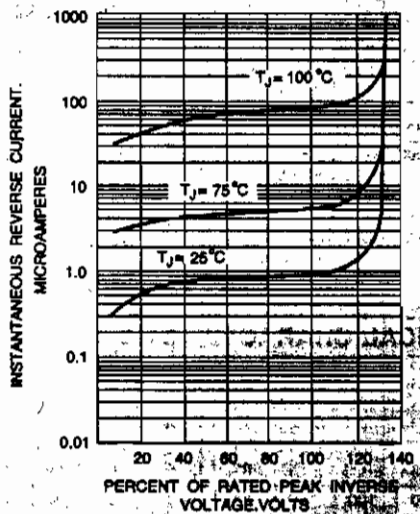

FIG. 3 - TYPICAL REVERSE CHARACTERISTICS

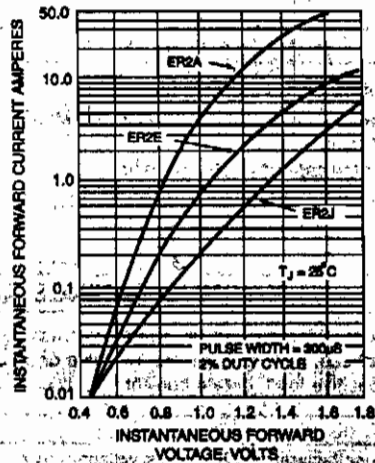

FIG. 4 - TYPICAL FORWARD CHARACTERISTICS

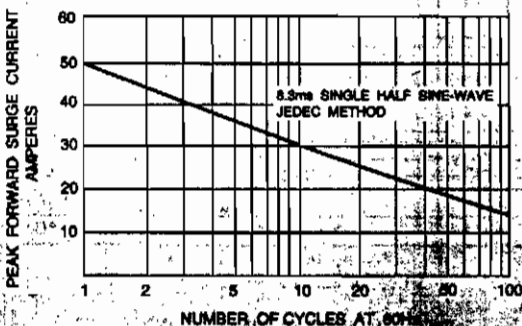

FIG. 5 - MAXIMUM NON-REPETITIVE PEAK FORWARD SURGE CURRENT

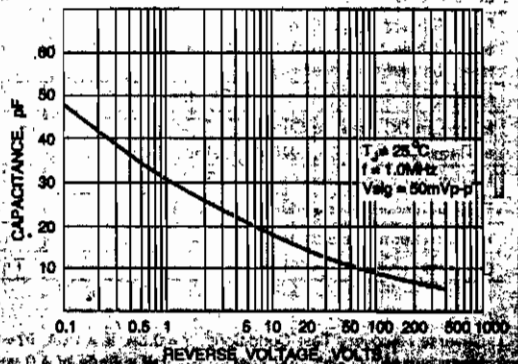

FIG. 6 - TYPICAL JUNCTION CAPACITANCE