

CONTENT (MLCC)

E STANDARD NUMBER..... 3

STRUCTURE..... 4

ORDERING CODE..... 4

GENERAL PURPOSE 5

 CLASS I: TEMPERATURE COMPENSATING TYPE..... 6

 CLASS II: HIGH DIELECTRIC CONSTANT TYPE 12

X5R Series..... 12

X6S Series..... 17

X7R Series..... 19

X7S Series..... 28

X7T Series..... 29

X7U Series..... 30

Y5V Series..... 31

 TEST SPEC..... 33

PACKAGE..... 37

OTHERS..... 41

E Standard Number

E3	1.0				2.2				4.7															
E6	1.0		1.5		2.2		3.3		4.7		6.8													
E12	1.0	1.2	1.5	1.8	2.2	2.7	3.3	3.9	4.7	5.6	6.8	8.2												
E24	1.0	1.1	1.2	1.3	1.5	1.6	1.8	2.0	2.2	2.4	2.7	3.0	3.3	3.6	3.9	4.3	4.7	5.1	5.6	6.2	6.8	7.5	8.2	9.1

Structure

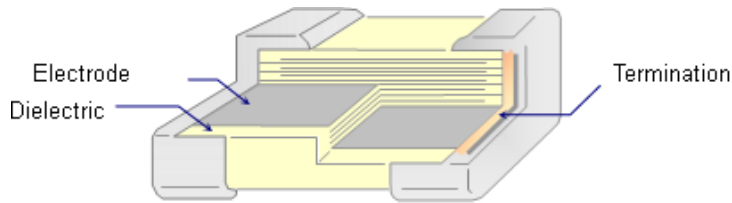

Ordering Code

C 1005 NP0 101 J G T S Δ

PRODUCT CODE

C = MLCC

SIZE in mm (EIA CODE, in inch)

0402(01005)	0603(0201)	1005 (0402)	1608 (0603)	2012 (0805)
3216 (1206)	3225(1210)	4520 (1808)	4532 (1812)	

T. C.

NP0: $0 \pm 30\text{ppm}/^\circ\text{C}$ -55°C to +125°C X5R: $\pm 15\%$ -55°C to +85°C
 X7R: $\pm 15\%$ X7S: $\pm 22\%$ X7T: $+22\%/-33\%$ X7U: $+22\%/-56\%$ -55°C to +125°C
 X6S: $\pm 22\%$ -55°C to +105°C Y5V: $+22\%/-82\%$ -30°C to +85°C

CAPACITANCE CODE

Expressed in pico-farads and identified by a three-digit number.
 First two digits represent significant figures.
 Last digit specifies the number of zeros.
 (Use 9 for 1.0 through 9.9pF ; Use 8 for 0.20 through 0.99pF)

Examples:

Code	Cap (pF)
478	0.47
229	2.2
101	100
102	1000

TOLERANCE CODE

A: $\pm 0.05\text{pF}$ B: $\pm 0.1\text{pF}$ C: $\pm 0.25\text{pF}$ D: $\pm 0.5\text{pF}$ F: $\pm 1\%$ G: $\pm 2\%$
 J: $\pm 5\%$ K: $\pm 10\%$ M: $\pm 20\%$ Z: $+80/-20\%$

VOLTAGE CODE

B: 4V C: 6.3V D: 10V E: 16V F: 25V N: 35V G: 50V H: 100V
 J: 200V K: 250V L: 500V M: 630V P: 1KV Q: 2KV R: 3KV S: 4KV

PACKAGING CODE

T: Paper tape reel Ø180mm (7") P: Embossed tape reel Ø180mm (7")
 N: Paper tape reel Ø250mm (10") D: Embossed tape reel Ø250mm (10")
 A: Paper tape reel Ø330mm (13") E: Embossed tape reel Ø330mm (13")
 W: Special Packing

Application Code

S: Standard Q: High Q/Low ESR F: Microwave A: Automotive Infotainment with AEC-Q200

Thickness Code

Code	Thick (mm)	Code	Thick(mm)	Code	Thick (mm)	Code	Thick (mm)
(blank)	Standard Thick	M	0.70	G	1.25	S	1.90
Z	0.20	D	0.80	H	1.50	--	--
A	0.30	E	0.85	L	1.60	--	--
Q	0.45	I	0.95	N	2.00	--	--
B	0.50	J	1.00	P	2.50	--	--
C	0.60	F	1.15	R	3.20	--	--

General Purpose

■ External Dimensions

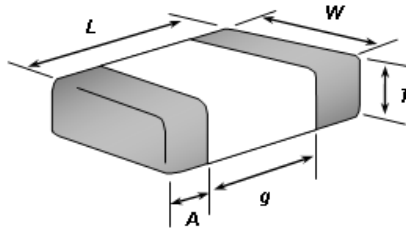

TYPE		Dimension (mm)				
Size (EIA Size)	Kind	L (Length)	W (Width)	T (Max.)	g (Min)	A (Min/Max)
C0603 (0201)	Standard	0.6 ± 0.03	0.30 ± 0.03	0.33	0.15	0.10 / 0.20
	Special (1)	0.6 ± 0.05	0.30 ± 0.05	0.35		
	Special (2)	0.6 ± 0.09	0.30 ± 0.09	0.39		0.10 / 0.25
C1005 (0402)	Standard	1.0 ± 0.05	0.50 ± 0.05	0.55	0.30	0.15 / 0.35
	Special (1)	1.0 ± 0.10	0.50 ± 0.10	0.60		
	Special (2)	1.0 ± 0.15	0.50 ± 0.15	0.65		
C1608 (0603)	Standard	1.6 ± 0.10	0.80 ± 0.10	0.90	0.50	0.25 / 0.65
	Special (1)	1.6 ± 0.15	0.80 ± 0.15	0.95		
	Special (2)	1.6 ± 0.20	0.80 ± 0.20	1.00		
C2012 (0805)	Standard	2.0 ± 0.15	1.25 ± 0.15	1.45	0.70	0.25 / 0.75
	Special (1)	2.0 ± 0.20	1.25 ± 0.20	1.45		
C3216 (1206)	Standard	3.2 ± 0.15	1.60 ± 0.15	1.80	1.50	0.25 / 0.75
	Special (1)	3.2 ± 0.20	1.60 ± 0.20	1.90		
	Special (2)	3.2 ± 0.30	1.60 ± 0.30	1.90		
C3225 (1210)	Standard	3.2 ± 0.30	2.50 ± 0.20	2.80	1.50	0.3 / 0.90
	Special (1)	3.2 ± 0.40	2.50 ± 0.30	2.80		

For special parts, please see the "Part Number & Characteristic" for detail specification.

● Class I: Temperature Compensating Type

■ Feature

1. Ultra-stable
2. Tight tolerance available
3. Low ESR (Frequency is within 800MHz)
4. Good frequency performance
5. No aging of capacitance
6. RoHS compliant
7. Halogen Free

■ Application

1. LC and RC tuned circuit
2. Filtering
3. Timing

■ Part Number & Characteristic

● C0603NP0_S Series (EIA0201)

RV	DARFON P/N	DARFON P/N 2	Measuring Condition	Capacitance		Available Tolerance	Thick. (mm)	Tolerance(mm)		DF (max.)	Standard Packing
				Value	Unit			L/W	Thick.		
50V	C0603NP0208	C0603NP0208	1V, 1MHz	0.20	pF	±0.25pF,±0.1pF,±0.05pF	0.30	±0.03	±0.03	0.25%	Paper,15Kpcs
	C0603NP0308	C0603NP0308	1V, 1MHz	0.30	pF	±0.25pF,±0.1pF,±0.05pF	0.30	±0.03	±0.03	0.25%	
	C0603NP0408	C0603NP0408	1V, 1MHz	0.40	pF	±0.25pF,±0.1pF,±0.05pF	0.30	±0.03	±0.03	0.25%	
	C0603NP0508	C0603NP0508	1V, 1MHz	0.50	pF	±0.25pF,±0.1pF,±0.05pF	0.30	±0.03	±0.03	0.24%	
	C0603NP0608	C0603NP0608	1V, 1MHz	0.60	pF	±0.25pF,±0.1pF,±0.05pF	0.30	±0.03	±0.03	0.24%	
	C0603NP0708	C0603NP0708	1V, 1MHz	0.70	pF	±0.25pF,±0.1pF,±0.05pF	0.30	±0.03	±0.03	0.24%	
	C0603NP0758	C0603NP0758	1V, 1MHz	0.75	pF	±0.25pF,±0.1pF,±0.05pF	0.30	±0.03	±0.03	0.24%	
	C0603NP0808	C0603NP0808	1V, 1MHz	0.80	pF	±0.25pF,±0.1pF,±0.05pF	0.30	±0.03	±0.03	0.24%	
	C0603NP0908	C0603NP0908	1V, 1MHz	0.90	pF	±0.25pF,±0.1pF,±0.05pF	0.30	±0.03	±0.03	0.24%	
	C0603NP0109	C0603NP0109	1V, 1MHz	1.0	pF	±0.25pF,±0.1pF,±0.05pF	0.30	±0.03	±0.03	0.24%	
	C0603NP0119	C0603NP0119	1V, 1MHz	1.1	pF	±0.25pF,±0.1pF	0.30	±0.03	±0.03	0.24%	
	C0603NP0129	C0603NP0129	1V, 1MHz	1.2	pF	±0.25pF,±0.1pF	0.30	±0.03	±0.03	0.24%	
	C0603NP0139	C0603NP0139	1V, 1MHz	1.3	pF	±0.25pF,±0.1pF	0.30	±0.03	±0.03	0.23%	
	C0603NP0159	C0603NP0159	1V, 1MHz	1.5	pF	±0.25pF,±0.1pF	0.30	±0.03	±0.03	0.23%	
	C0603NP0169	C0603NP0169	1V, 1MHz	1.6	pF	±0.25pF,±0.1pF	0.30	±0.03	±0.03	0.23%	
	C0603NP0189	C0603NP0189	1V, 1MHz	1.8	pF	±0.25pF,±0.1pF	0.30	±0.03	±0.03	0.23%	
	C0603NP0209	C0603NP0209	1V, 1MHz	2.0	pF	±0.25pF,±0.1pF	0.30	±0.03	±0.03	0.23%	
	C0603NP0229	C0603NP0229	1V, 1MHz	2.2	pF	±0.25pF,±0.1pF	0.30	±0.03	±0.03	0.23%	
	C0603NP0249	C0603NP0249	1V, 1MHz	2.4	pF	±0.25pF,±0.1pF	0.30	±0.03	±0.03	0.22%	
	C0603NP0279	C0603NP0279	1V, 1MHz	2.7	pF	±0.25pF,±0.1pF	0.30	±0.03	±0.03	0.22%	
	C0603NP0309	C0603NP0309	1V, 1MHz	3.0	pF	±0.25pF,±0.1pF	0.30	±0.03	±0.03	0.22%	
	C0603NP0339	C0603NP0339	1V, 1MHz	3.3	pF	±0.25pF,±0.1pF	0.30	±0.03	±0.03	0.21%	
	C0603NP0359	C0603NP0359	1V, 1MHz	3.5	pF	±0.25pF,±0.1pF	0.30	±0.03	±0.03	0.21%	
	C0603NP0399	C0603NP0399	1V, 1MHz	3.9	pF	±0.25pF,±0.1pF	0.30	±0.03	±0.03	0.21%	
	C0603NP0409	C0603NP0409	1V, 1MHz	4.0	pF	±0.25pF,±0.1pF	0.30	±0.03	±0.03	0.21%	
	C0603NP0439	C0603NP0439	1V, 1MHz	4.3	pF	±0.25pF,±0.1pF	0.30	±0.03	±0.03	0.21%	
	C0603NP0479	C0603NP0479	1V, 1MHz	4.7	pF	±0.25pF,±0.1pF	0.30	±0.03	±0.03	0.20%	
	C0603NP0509	C0603NP0509	1V, 1MHz	5.0	pF	±0.5pF,±0.25pF,±0.1pF	0.30	±0.03	±0.03	0.20%	
	C0603NP0519	C0603NP0519	1V, 1MHz	5.1	pF	±0.5pF,±0.25pF,±0.1pF	0.30	±0.03	±0.03	0.20%	
	C0603NP0569	C0603NP0569	1V, 1MHz	5.6	pF	±0.5pF,±0.25pF,±0.1pF	0.30	±0.03	±0.03	0.20%	
	C0603NP0609	C0603NP0609	1V, 1MHz	6.0	pF	±0.5pF,±0.25pF,±0.1pF	0.30	±0.03	±0.03	0.19%	
	C0603NP0629	C0603NP0629	1V, 1MHz	6.2	pF	±0.5pF,±0.25pF,±0.1pF	0.30	±0.03	±0.03	0.19%	
	C0603NP0689	C0603NP0689	1V, 1MHz	6.8	pF	±0.5pF,±0.25pF,±0.1pF	0.30	±0.03	±0.03	0.19%	
	C0603NP0709	C0603NP0709	1V, 1MHz	7.0	pF	±0.5pF,±0.25pF,±0.1pF	0.30	±0.03	±0.03	0.19%	
	C0603NP0759	C0603NP0759	1V, 1MHz	7.5	pF	±0.5pF,±0.25pF,±0.1pF	0.30	±0.03	±0.03	0.18%	
	C0603NP0809	C0603NP0809	1V, 1MHz	8.0	pF	±0.5pF,±0.25pF,±0.1pF	0.30	±0.03	±0.03	0.18%	
	C0603NP0829	C0603NP0829	1V, 1MHz	8.2	pF	±0.5pF,±0.25pF,±0.1pF	0.30	±0.03	±0.03	0.18%	
	C0603NP0909	C0603NP0909	1V, 1MHz	9.0	pF	±0.5pF,±0.25pF,±0.1pF	0.30	±0.03	±0.03	0.17%	
	C0603NP0100	C0603NP0100	1V, 1MHz	10	pF	±5%,±2%,±1%	0.30	±0.03	±0.03	0.17%	
	C0603NP0120	C0603NP0120	1V, 1MHz	12	pF	±5%,±2%,±1%	0.30	±0.03	±0.03	0.16%	
C0603NP0150	C0603NP0150	1V, 1MHz	15	pF	±5%,±2%,±1%	0.30	±0.03	±0.03	0.14%		
C0603NP0180	C0603NP0180	1V, 1MHz	18	pF	±5%,±2%,±1%	0.30	±0.03	±0.03	0.13%		
C0603NP0200	C0603NP0200	1V, 1MHz	20	pF	±5%,±2%,±1%	0.30	±0.03	±0.03	0.13%		
C0603NP0220	C0603NP0220	1V, 1MHz	22	pF	±5%,±2%,±1%	0.30	±0.03	±0.03	0.12%		
C0603NP0270	C0603NP0270	1V, 1MHz	27	pF	±5%,±2%,±1%	0.30	±0.03	±0.03	0.11%		
C0603NP0330	C0603NP0330	1V, 1MHz	33	pF	±5%,±2%,±1%	0.30	±0.03	±0.03	0.10%		
C0603NP0390	C0603NP0390	1V, 1MHz	39	pF	±5%,±2%,±1%	0.30	±0.03	±0.03	0.10%		
C0603NP0470	C0603NP0470	1V, 1MHz	47	pF	±5%,±2%,±1%	0.30	±0.03	±0.03	0.10%		
C0603NP0560	C0603NP0560	1V, 1MHz	56	pF	±5%,±2%,±1%	0.30	±0.03	±0.03	0.10%		
C0603NP0680	C0603NP0680	1V, 1MHz	68	pF	±5%,±2%,±1%	0.30	±0.03	±0.03	0.10%		
C0603NP0820	C0603NP0820	1V, 1MHz	82	pF	±5%,±2%,±1%	0.30	±0.03	±0.03	0.10%		
C0603NP0101	C0603NP0101	1V, 1MHz	100	pF	±5%,±2%,±1%	0.30	±0.03	±0.03	0.10%		

□ Tolerance Code: A=±0.05 pF, B=±0.1pF, C=±0.25pF ,D=±0.5pF, F=±1%, G=±2%, J=±5%; Special tolerance on the request.

RV	DARFON P/N	DARFON P/N 2	Measuring Condition	Capacitance		Available Tolerance	Thick. (mm)	Tolerance(mm)		DF (max.)	Standard Packing
				Value	Unit			L/W	Thick.		
25V	C0603NP0208	C0603NP0208	1V, 1MHz	0.20	pF	±0.25pF,±0.1pF,±0.05pF	0.30	±0.03	±0.03	0.25%	Paper, 15Kpcs
	C0603NP0308	C0603NP0308	1V, 1MHz	0.30	pF	±0.25pF,±0.1pF,±0.05pF	0.30	±0.03	±0.03	0.25%	
	C0603NP0408	C0603NP0408	1V, 1MHz	0.40	pF	±0.25pF,±0.1pF,±0.05pF	0.30	±0.03	±0.03	0.25%	
	C0603NP0508	C0603NP0508	1V, 1MHz	0.50	pF	±0.25pF,±0.1pF,±0.05pF	0.30	±0.03	±0.03	0.24%	
	C0603NP0608	C0603NP0608	1V, 1MHz	0.60	pF	±0.25pF,±0.1pF,±0.05pF	0.30	±0.03	±0.03	0.24%	
	C0603NP0708	C0603NP0708	1V, 1MHz	0.70	pF	±0.25pF,±0.1pF,±0.05pF	0.30	±0.03	±0.03	0.24%	
	C0603NP0758	C0603NP0758	1V, 1MHz	0.75	pF	±0.25pF,±0.1pF,±0.05pF	0.30	±0.03	±0.03	0.24%	
	C0603NP0808	C0603NP0808	1V, 1MHz	0.80	pF	±0.25pF,±0.1pF,±0.05pF	0.30	±0.03	±0.03	0.24%	
	C0603NP0908	C0603NP0908	1V, 1MHz	0.90	pF	±0.25pF,±0.1pF,±0.05pF	0.30	±0.03	±0.03	0.24%	
	C0603NP0109	C0603NP0109	1V, 1MHz	1.0	pF	±0.25pF,±0.1pF,±0.05pF	0.30	±0.03	±0.03	0.24%	
	C0603NP0129	C0603NP0129	1V, 1MHz	1.2	pF	±0.25pF,±0.1pF	0.30	±0.03	±0.03	0.24%	
	C0603NP0139	C0603NP0139	1V, 1MHz	1.3	pF	±0.25pF,±0.1pF	0.30	±0.03	±0.03	0.23%	
	C0603NP0159	C0603NP0159	1V, 1MHz	1.5	pF	±0.25pF,±0.1pF	0.30	±0.03	±0.03	0.23%	
	C0603NP0169	C0603NP0169	1V, 1MHz	1.6	pF	±0.25pF,±0.1pF	0.30	±0.03	±0.03	0.23%	
	C0603NP0189	C0603NP0189	1V, 1MHz	1.8	pF	±0.25pF,±0.1pF	0.30	±0.03	±0.03	0.23%	
	C0603NP0209	C0603NP0209	1V, 1MHz	2.0	pF	±0.25pF,±0.1pF	0.30	±0.03	±0.03	0.23%	
	C0603NP0229	C0603NP0229	1V, 1MHz	2.2	pF	±0.25pF,±0.1pF	0.30	±0.03	±0.03	0.23%	
	C0603NP0279	C0603NP0279	1V, 1MHz	2.7	pF	±0.25pF,±0.1pF	0.30	±0.03	±0.03	0.22%	
	C0603NP0309	C0603NP0309	1V, 1MHz	3.0	pF	±0.25pF,±0.1pF	0.30	±0.03	±0.03	0.22%	
	C0603NP0339	C0603NP0339	1V, 1MHz	3.3	pF	±0.25pF,±0.1pF	0.30	±0.03	±0.03	0.21%	
	C0603NP0359	C0603NP0359	1V, 1MHz	3.5	pF	±0.25pF,±0.1pF	0.30	±0.03	±0.03	0.21%	
	C0603NP0399	C0603NP0399	1V, 1MHz	3.9	pF	±0.25pF,±0.1pF	0.30	±0.03	±0.03	0.21%	
	C0603NP0409	C0603NP0409	1V, 1MHz	4.0	pF	±0.25pF,±0.1pF	0.30	±0.03	±0.03	0.21%	
	C0603NP0439	C0603NP0439	1V, 1MHz	4.3	pF	±0.25pF,±0.1pF	0.30	±0.03	±0.03	0.21%	
	C0603NP0479	C0603NP0479	1V, 1MHz	4.7	pF	±0.25pF,±0.1pF	0.30	±0.03	±0.03	0.20%	
	C0603NP0509	C0603NP0509	1V, 1MHz	5.0	pF	±0.5pF,±0.25pF,±0.1pF	0.30	±0.03	±0.03	0.20%	
	C0603NP0519	C0603NP0519	1V, 1MHz	5.1	pF	±0.5pF,±0.25pF,±0.1pF	0.30	±0.03	±0.03	0.20%	
	C0603NP0569	C0603NP0569	1V, 1MHz	5.6	pF	±0.5pF,±0.25pF,±0.1pF	0.30	±0.03	±0.03	0.20%	
	C0603NP0609	C0603NP0609	1V, 1MHz	6.0	pF	±0.5pF,±0.25pF,±0.1pF	0.30	±0.03	±0.03	0.19%	
	C0603NP0629	C0603NP0629	1V, 1MHz	6.2	pF	±0.5pF,±0.25pF,±0.1pF	0.30	±0.03	±0.03	0.19%	
	C0603NP0689	C0603NP0689	1V, 1MHz	6.8	pF	±0.5pF,±0.25pF,±0.1pF	0.30	±0.03	±0.03	0.19%	
	C0603NP0709	C0603NP0709	1V, 1MHz	7.0	pF	±0.5pF,±0.25pF,±0.1pF	0.30	±0.03	±0.03	0.19%	
	C0603NP0759	C0603NP0759	1V, 1MHz	7.5	pF	±0.5pF,±0.25pF,±0.1pF	0.30	±0.03	±0.03	0.18%	
	C0603NP0809	C0603NP0809	1V, 1MHz	8.0	pF	±0.5pF,±0.25pF,±0.1pF	0.30	±0.03	±0.03	0.18%	
	C0603NP0829	C0603NP0829	1V, 1MHz	8.2	pF	±0.5pF,±0.25pF,±0.1pF	0.30	±0.03	±0.03	0.18%	
	C0603NP0909	C0603NP0909	1V, 1MHz	9.0	pF	±0.5pF,±0.25pF,±0.1pF	0.30	±0.03	±0.03	0.17%	
	C0603NP0100	C0603NP0100	1V, 1MHz	10	pF	±5%,±2%,±1%	0.30	±0.03	±0.03	0.17%	
	C0603NP0120	C0603NP0120	1V, 1MHz	12	pF	±5%,±2%,±1%	0.30	±0.03	±0.03	0.16%	
	C0603NP0150	C0603NP0150	1V, 1MHz	15	pF	±5%,±2%,±1%	0.30	±0.03	±0.03	0.14%	
	C0603NP0180	C0603NP0180	1V, 1MHz	18	pF	±5%,±2%,±1%	0.30	±0.03	±0.03	0.13%	
C0603NP0200	C0603NP0200	1V, 1MHz	20	pF	±5%,±2%,±1%	0.30	±0.03	±0.03	0.13%		
C0603NP0220	C0603NP0220	1V, 1MHz	22	pF	±5%,±2%,±1%	0.30	±0.03	±0.03	0.12%		
C0603NP0240	C0603NP0240	1V, 1MHz	24	pF	±5%,±2%,±1%	0.30	±0.03	±0.03	0.11%		
C0603NP0270	C0603NP0270	1V, 1MHz	27	pF	±5%,±2%,±1%	0.30	±0.03	±0.03	0.11%		
C0603NP0330	C0603NP0330	1V, 1MHz	33	pF	±5%,±2%,±1%	0.30	±0.03	±0.03	0.10%		
C0603NP0390	C0603NP0390	1V, 1MHz	39	pF	±5%,±2%,±1%	0.30	±0.03	±0.03	0.10%		
C0603NP0470	C0603NP0470	1V, 1MHz	47	pF	±5%,±2%,±1%	0.30	±0.03	±0.03	0.10%		
C0603NP0560	C0603NP0560	1V, 1MHz	56	pF	±5%,±2%,±1%	0.30	±0.03	±0.03	0.10%		
C0603NP0680	C0603NP0680	1V, 1MHz	68	pF	±5%,±2%,±1%	0.30	±0.03	±0.03	0.10%		
C0603NP0820	C0603NP0820	1V, 1MHz	82	pF	±5%,±2%,±1%	0.30	±0.03	±0.03	0.10%		
C0603NP0101	C0603NP0101	1V, 1MHz	100	pF	±5%,±2%,±1%	0.30	±0.03	±0.03	0.10%		
16V	C0603NP0279	C0603NP0279	1V, 1MHz	2.7	pF	±0.25pF,±0.1pF	0.30	±0.03	±0.03	0.22%	Paper, 15Kpcs
	C0603NP0330	C0603NP0330	1V, 1MHz	33	pF	±5%,±2%,±1%	0.30	±0.03	±0.03	0.10%	

● C1005NP0_S Series (EIA0402)

RV	DARFON P/N	DARFON P/N 2	Measuring Condition	Capacitance		Available Tolerance	Thick. (mm)	Tolerance(mm)		DF (max.)	Standard Packing
				Value	Unit			L/W	Thick.		
50V	C1005NP0208	C1005NP0208	1V, 1MHz	0.20	pF	±0.25pF,±0.1pF,±0.05pF	0.50	±0.05	±0.05	0.25%	Paper, 10Kpcs
	C1005NP0308	C1005NP0308	1V, 1MHz	0.30	pF	±0.25pF,±0.1pF,±0.05pF	0.50	±0.05	±0.05	0.25%	
	C1005NP0408	C1005NP0408	1V, 1MHz	0.40	pF	±0.25pF,±0.1pF,±0.05pF	0.50	±0.05	±0.05	0.25%	
	C1005NP0508	C1005NP0508	1V, 1MHz	0.50	pF	±0.25pF,±0.1pF,±0.05pF	0.50	±0.05	±0.05	0.24%	
	C1005NP0608	C1005NP0608	1V, 1MHz	0.60	pF	±0.25pF,±0.1pF,±0.05pF	0.50	±0.05	±0.05	0.24%	
	C1005NP0688	C1005NP0688	1V, 1MHz	0.68	pF	±0.25pF,±0.1pF,±0.05pF	0.50	±0.05	±0.05	0.24%	
	C1005NP0708	C1005NP0708	1V, 1MHz	0.70	pF	±0.25pF,±0.1pF,±0.05pF	0.50	±0.05	±0.05	0.24%	
	C1005NP0808	C1005NP0808	1V, 1MHz	0.80	pF	±0.25pF,±0.1pF,±0.05pF	0.50	±0.05	±0.05	0.24%	
	C1005NP0828	C1005NP0828	1V, 1MHz	0.82	pF	±0.25pF,±0.1pF,±0.05pF	0.50	±0.05	±0.05	0.24%	
	C1005NP0908	C1005NP0908	1V, 1MHz	0.90	pF	±0.25pF,±0.1pF,±0.05pF	0.50	±0.05	±0.05	0.24%	
	C1005NP109	C1005NP109	1V, 1MHz	1.0	pF	±0.25pF,±0.1pF,±0.05pF	0.50	±0.05	±0.05	0.24%	
	C1005NP129	C1005NP129	1V, 1MHz	1.2	pF	±0.25pF,±0.1pF,±0.05pF	0.50	±0.05	±0.05	0.24%	
	C1005NP139	C1005NP139	1V, 1MHz	1.3	pF	±0.25pF,±0.1pF,±0.05pF	0.50	±0.05	±0.05	0.23%	
	C1005NP159	C1005NP159	1V, 1MHz	1.5	pF	±0.25pF,±0.1pF,±0.05pF	0.50	±0.05	±0.05	0.23%	
	C1005NP189	C1005NP189	1V, 1MHz	1.8	pF	±0.25pF,±0.1pF,±0.05pF	0.50	±0.05	±0.05	0.23%	
	C1005NP209	C1005NP209	1V, 1MHz	2.0	pF	±0.25pF,±0.1pF,±0.05pF	0.50	±0.05	±0.05	0.23%	
	C1005NP229	C1005NP229	1V, 1MHz	2.2	pF	±0.25pF,±0.1pF,±0.05pF	0.50	±0.05	±0.05	0.23%	
	C1005NP249	C1005NP249	1V, 1MHz	2.4	pF	±0.25pF,±0.1pF,±0.05pF	0.50	±0.05	±0.05	0.22%	
	C1005NP259	C1005NP259	1V, 1MHz	2.5	pF	±0.25pF,±0.1pF,±0.05pF	0.50	±0.05	±0.05	0.22%	
	C1005NP279	C1005NP279	1V, 1MHz	2.7	pF	±0.25pF,±0.1pF,±0.05pF	0.50	±0.05	±0.05	0.22%	
	C1005NP309	C1005NP309	1V, 1MHz	3.0	pF	±0.25pF,±0.1pF,±0.05pF	0.50	±0.05	±0.05	0.22%	
	C1005NP339	C1005NP339	1V, 1MHz	3.3	pF	±0.25pF,±0.1pF,±0.05pF	0.50	±0.05	±0.05	0.21%	
	C1005NP369	C1005NP369	1V, 1MHz	3.6	pF	±0.25pF,±0.1pF,±0.05pF	0.50	±0.05	±0.05	0.21%	
	C1005NP399	C1005NP399	1V, 1MHz	3.9	pF	±0.25pF,±0.1pF,±0.05pF	0.50	±0.05	±0.05	0.21%	
	C1005NP409	C1005NP409	1V, 1MHz	4.0	pF	±0.25pF,±0.1pF,±0.05pF	0.50	±0.05	±0.05	0.21%	
	C1005NP439	C1005NP439	1V, 1MHz	4.3	pF	±0.25pF,±0.1pF,±0.05pF	0.50	±0.05	±0.05	0.21%	
	C1005NP479	C1005NP479	1V, 1MHz	4.7	pF	±0.25pF,±0.1pF,±0.05pF	0.50	±0.05	±0.05	0.20%	
	C1005NP509	C1005NP509	1V, 1MHz	5.0	pF	±0.5pF,±0.25pF,±0.1pF	0.50	±0.05	±0.05	0.20%	
	C1005NP519	C1005NP519	1V, 1MHz	5.1	pF	±0.5pF,±0.25pF,±0.1pF	0.50	±0.05	±0.05	0.20%	
	C1005NP569	C1005NP569	1V, 1MHz	5.6	pF	±0.5pF,±0.25pF,±0.1pF	0.50	±0.05	±0.05	0.20%	
	C1005NP609	C1005NP609	1V, 1MHz	6.0	pF	±0.5pF,±0.25pF,±0.1pF	0.50	±0.05	±0.05	0.19%	
	C1005NP629	C1005NP629	1V, 1MHz	6.2	pF	±0.5pF,±0.25pF,±0.1pF	0.50	±0.05	±0.05	0.19%	
	C1005NP689	C1005NP689	1V, 1MHz	6.8	pF	±0.5pF,±0.25pF,±0.1pF	0.50	±0.05	±0.05	0.19%	
	C1005NP709	C1005NP709	1V, 1MHz	7.0	pF	±0.5pF,±0.25pF,±0.1pF	0.50	±0.05	±0.05	0.19%	
	C1005NP759	C1005NP759	1V, 1MHz	7.5	pF	±0.5pF,±0.25pF,±0.1pF	0.50	±0.05	±0.05	0.18%	
	C1005NP809	C1005NP809	1V, 1MHz	8.0	pF	±0.5pF,±0.25pF,±0.1pF	0.50	±0.05	±0.05	0.18%	
	C1005NP829	C1005NP829	1V, 1MHz	8.2	pF	±0.5pF,±0.25pF,±0.1pF	0.50	±0.05	±0.05	0.18%	
	C1005NP909	C1005NP909	1V, 1MHz	9.0	pF	±0.5pF,±0.25pF,±0.1pF	0.50	±0.05	±0.05	0.17%	
	C1005NP919	C1005NP919	1V, 1MHz	9.1	pF	±0.5pF,±0.25pF,±0.1pF	0.50	±0.05	±0.05	0.17%	
	C1005NP100	C1005NP100	1V, 1MHz	10	pF	±5%,±2%,±1%	0.50	±0.05	±0.05	0.17%	
	C1005NP110	C1005NP110	1V, 1MHz	11	pF	±5%,±2%,±1%	0.50	±0.05	±0.05	0.16%	
	C1005NP120	C1005NP120	1V, 1MHz	12	pF	±5%,±2%,±1%	0.50	±0.05	±0.05	0.16%	
C1005NP150	C1005NP150	1V, 1MHz	15	pF	±5%,±2%,±1%	0.50	±0.05	±0.05	0.14%		
C1005NP160	C1005NP160	1V, 1MHz	16	pF	±5%,±2%,±1%	0.50	±0.05	±0.05	0.14%		
C1005NP180	C1005NP180	1V, 1MHz	18	pF	±5%,±2%,±1%	0.50	±0.05	±0.05	0.13%		
C1005NP200	C1005NP200	1V, 1MHz	20	pF	±5%,±2%,±1%	0.50	±0.05	±0.05	0.13%		
C1005NP220	C1005NP220	1V, 1MHz	22	pF	±5%,±2%,±1%	0.50	±0.05	±0.05	0.12%		
C1005NP240	C1005NP240	1V, 1MHz	24	pF	±5%,±2%,±1%	0.50	±0.05	±0.05	0.11%		
C1005NP270	C1005NP270	1V, 1MHz	27	pF	±5%,±2%,±1%	0.50	±0.05	±0.05	0.11%		
C1005NP300	C1005NP300	1V, 1MHz	30	pF	±5%,±2%,±1%	0.50	±0.05	±0.05	0.10%		
C1005NP330	C1005NP330	1V, 1MHz	33	pF	±5%,±2%,±1%	0.50	±0.05	±0.05	0.10%		
C1005NP360	C1005NP360	1V, 1MHz	36	pF	±5%,±2%,±1%	0.50	±0.05	±0.05	0.10%		
C1005NP390	C1005NP390	1V, 1MHz	39	pF	±5%,±2%,±1%	0.50	±0.05	±0.05	0.10%		
C1005NP430	C1005NP430	1V, 1MHz	43	pF	±5%,±2%,±1%	0.50	±0.05	±0.05	0.10%		
C1005NP470	C1005NP470	1V, 1MHz	47	pF	±5%,±2%,±1%	0.50	±0.05	±0.05	0.10%		
C1005NP510	C1005NP510	1V, 1MHz	51	pF	±5%,±2%,±1%	0.50	±0.05	±0.05	0.10%		
C1005NP560	C1005NP560	1V, 1MHz	56	pF	±5%,±2%,±1%	0.50	±0.05	±0.05	0.10%		
C1005NP620	C1005NP620	1V, 1MHz	62	pF	±5%,±2%,±1%	0.50	±0.05	±0.05	0.10%		
C1005NP680	C1005NP680	1V, 1MHz	68	pF	±5%,±2%,±1%	0.50	±0.05	±0.05	0.10%		
C1005NP750	C1005NP750	1V, 1MHz	75	pF	±5%,±2%,±1%	0.50	±0.05	±0.05	0.10%		
C1005NP820	C1005NP820	1V, 1MHz	82	pF	±5%,±2%,±1%	0.50	±0.05	±0.05	0.10%		
C1005NP910	C1005NP910	1V, 1MHz	91	pF	±5%,±2%,±1%	0.50	±0.05	±0.05	0.10%		
C1005NP101	C1005NP101	1V, 1MHz	100	pF	±5%,±2%,±1%	0.50	±0.05	±0.05	0.10%		
C1005NP121	C1005NP121	1V, 1MHz	120	pF	±5%,±2%,±1%	0.50	±0.05	±0.05	0.10%		
C1005NP151	C1005NP151	1V, 1MHz	150	pF	±5%,±2%,±1%	0.50	±0.05	±0.05	0.10%		
C1005NP181	C1005NP181	1V, 1MHz	180	pF	±5%,±2%,±1%	0.50	±0.05	±0.05	0.10%		
C1005NP201	C1005NP201	1V, 1MHz	200	pF	±5%,±2%,±1%	0.50	±0.05	±0.05	0.10%		
C1005NP221	C1005NP221	1V, 1MHz	220	pF	±5%,±2%,±1%	0.50	±0.05	±0.05	0.10%		

□ Tolerance Code: A=±0.05 pF, B=±0.1pF, C=±0.25pF ,D=±0.5pF, F=±1%, G=±2%, J=±5%; Special tolerance on the request.

RV	DARFON P/N	DARFON P/N 2	Measuring Condition	Capacitance		Available Tolerance	Thick. (mm)	Tolerance(mm)		DF (max.)	Standard Packing
				Value	Unit			L/W	Thick.		
50V	C1005NP0271 GTS	C1005NP0271 GT	1V, 1MHz	270	pF	±5%, ±2%, ±1%	0.50	±0.05	±0.05	0.10%	Paper, 10Kpcs
	C1005NP0301 GTS	C1005NP0301 GT	1V, 1MHz	300	pF	±5%, ±2%	0.50	±0.05	±0.05	0.10%	
	C1005NP0331 GTS	C1005NP0331 GT	1V, 1MHz	330	pF	±5%, ±2%	0.50	±0.05	±0.05	0.10%	
	C1005NP0391 GTS	C1005NP0391 GT	1V, 1MHz	390	pF	±5%, ±2%, ±1%	0.50	±0.05	±0.05	0.10%	
	C1005NP0471 GTS	C1005NP0471 GT	1V, 1MHz	470	pF	±5%, ±2%	0.50	±0.05	±0.05	0.10%	
	C1005NP0561 GTS	C1005NP0561 GT	1V, 1MHz	560	pF	±5%, ±2%	0.50	±0.05	±0.05	0.10%	
	C1005NP0681 GTS	C1005NP0681 GT	1V, 1MHz	680	pF	±5%, ±2%, ±1%	0.50	±0.05	±0.05	0.10%	
	C1005NP0821 GTS	C1005NP0821 GT	1V, 1MHz	820	pF	±5%, ±2%	0.50	±0.05	±0.05	0.10%	
25V	C1005NP0102 GTS	C1005NP0102 GT	1V, 1MHz	1.0	nF	±5%, ±2%	0.50	±0.05	±0.05	0.10%	Paper, 10Kpcs
	C1005NP0308 FTS	C1005NP0308 FT	1V, 1MHz	0.3	pF	±0.25pF, ±0.1pF, ±0.05pF	0.50	±0.05	±0.05	0.25%	
	C1005NP0120 FTS	C1005NP0120 FT	1V, 1MHz	12.0	pF	±5%, ±2%, ±1%	0.50	±0.05	±0.05	0.16%	
16V	C1005NP0102 JFTS	C1005NP0102 JFT	1V, 1MHz	1.0	nF	±5%	0.50	±0.05	±0.05	0.10%	Paper, 10Kpcs
	C1005NP0470 ETS	C1005NP0470 ET	1V, 1MHz	47	pF	±5%, ±2%, ±1%	0.50	±0.05	±0.05	0.10%	
10V	C1005NP0331 ETS	C1005NP0331 ET	1V, 1MHz	330	pF	±5%, ±2%	0.50	±0.05	±0.05	0.10%	Paper, 10Kpcs
	C1005NP0220 DTS	C1005NP0220 DT	1V, 1MHz	22	pF	±5%, ±2%, ±1%	0.50	±0.05	±0.05	0.12%	

● C1608NP0_S Series (EIA0603)

RV	DARFON P/N	DARFON P/N 2	Measuring Condition	Capacitance		Available Tolerance	Thick. (mm)	Tolerance(mm)		DF (max.)	Standard Packing
				Value	Unit			L/W	Thick.		
50V	C1608NP0308 GTS	C1608NP0308 GT	1V, 1MHz	0.30	pF	±0.25pF, ±0.1pF, ±0.05pF	0.80	±0.10	±0.10	0.25%	Paper, 4Kpcs
	C1608NP0508 GTS	C1608NP0508 GT	1V, 1MHz	0.50	pF	±0.25pF, ±0.1pF, ±0.05pF	0.80	±0.10	±0.10	0.24%	
	C1608NP0758 GTS	C1608NP0758 GT	1V, 1MHz	0.75	pF	±0.25pF, ±0.1pF, ±0.05pF	0.80	±0.10	±0.10	0.24%	
	C1608NP0109 GTS	C1608NP0109 GT	1V, 1MHz	1.0	pF	±0.25pF, ±0.1pF	0.80	±0.10	±0.10	0.24%	
	C1608NP0129 GTS	C1608NP0129 GT	1V, 1MHz	1.2	pF	±0.25pF, ±0.1pF	0.80	±0.10	±0.10	0.24%	
	C1608NP0159 GTS	C1608NP0159 GT	1V, 1MHz	1.5	pF	±0.25pF, ±0.1pF	0.80	±0.10	±0.10	0.23%	
	C1608NP0189 GTS	C1608NP0189 GT	1V, 1MHz	1.8	pF	±0.25pF, ±0.1pF	0.80	±0.10	±0.10	0.23%	
	C1608NP0209 GTS	C1608NP0209 GT	1V, 1MHz	2.0	pF	±0.25pF, ±0.1pF	0.80	±0.10	±0.10	0.23%	
	C1608NP0229 GTS	C1608NP0229 GT	1V, 1MHz	2.2	pF	±0.25pF, ±0.1pF	0.80	±0.10	±0.10	0.23%	
	C1608NP0249 GTS	C1608NP0249 GT	1V, 1MHz	2.4	pF	±0.25pF, ±0.1pF	0.80	±0.10	±0.10	0.22%	
	C1608NP0279 GTS	C1608NP0279 GT	1V, 1MHz	2.7	pF	±0.25pF, ±0.1pF	0.80	±0.10	±0.10	0.22%	
	C1608NP0309 GTS	C1608NP0309 GT	1V, 1MHz	3.0	pF	±0.25pF, ±0.1pF	0.80	±0.10	±0.10	0.22%	
	C1608NP0339 GTS	C1608NP0339 GT	1V, 1MHz	3.3	pF	±0.25pF, ±0.1pF	0.80	±0.10	±0.10	0.21%	
	C1608NP0399 GTS	C1608NP0399 GT	1V, 1MHz	3.9	pF	±0.25pF, ±0.1pF	0.80	±0.10	±0.10	0.21%	
	C1608NP0409 GTS	C1608NP0409 GT	1V, 1MHz	4.0	pF	±0.25pF, ±0.1pF	0.80	±0.10	±0.10	0.21%	
	C1608NP0479 GTS	C1608NP0479 GT	1V, 1MHz	4.7	pF	±0.25pF, ±0.1pF	0.80	±0.10	±0.10	0.20%	
	C1608NP0509 GTS	C1608NP0509 GT	1V, 1MHz	5.0	pF	±0.5pF, ±0.25pF, ±0.1pF	0.80	±0.10	±0.10	0.20%	
	C1608NP0569 GTS	C1608NP0569 GT	1V, 1MHz	5.6	pF	±0.5pF, ±0.25pF, ±0.1pF	0.80	±0.10	±0.10	0.20%	
	C1608NP0609 GTS	C1608NP0609 GT	1V, 1MHz	6.0	pF	±0.5pF, ±0.25pF, ±0.1pF	0.80	±0.10	±0.10	0.19%	
	C1608NP0629 GTS	C1608NP0629 GT	1V, 1MHz	6.2	pF	±0.5pF, ±0.25pF, ±0.1pF	0.80	±0.10	±0.10	0.19%	
	C1608NP0689 GTS	C1608NP0689 GT	1V, 1MHz	6.8	pF	±0.5pF, ±0.25pF, ±0.1pF	0.80	±0.10	±0.10	0.19%	
	C1608NP0709 GTS	C1608NP0709 GT	1V, 1MHz	7.0	pF	±0.5pF, ±0.25pF, ±0.1pF	0.80	±0.10	±0.10	0.19%	
	C1608NP0829 GTS	C1608NP0829 GT	1V, 1MHz	8.2	pF	±0.5pF, ±0.25pF, ±0.1pF	0.80	±0.10	±0.10	0.18%	
	C1608NP0909 GTS	C1608NP0909 GT	1V, 1MHz	9.0	pF	±0.5pF, ±0.25pF, ±0.1pF	0.80	±0.10	±0.10	0.17%	
	C1608NP0100 GTS	C1608NP0100 GT	1V, 1MHz	10	pF	±5%, ±2%, ±1%	0.80	±0.10	±0.10	0.17%	
	C1608NP0110 GTS	C1608NP0110 GT	1V, 1MHz	11	pF	±5%, ±2%, ±1%	0.80	±0.10	±0.10	0.16%	
	C1608NP0120 GTS	C1608NP0120 GT	1V, 1MHz	12	pF	±5%, ±2%, ±1%	0.80	±0.10	±0.10	0.16%	
	C1608NP0150 GTS	C1608NP0150 GT	1V, 1MHz	15	pF	±5%, ±2%, ±1%	0.80	±0.10	±0.10	0.14%	
	C1608NP0180 GTS	C1608NP0180 GT	1V, 1MHz	18	pF	±5%, ±2%, ±1%	0.80	±0.10	±0.10	0.13%	
	C1608NP0200 GTS	C1608NP0200 GT	1V, 1MHz	20	pF	±5%, ±2%, ±1%	0.80	±0.10	±0.10	0.13%	
	C1608NP0220 GTS	C1608NP0220 GT	1V, 1MHz	22	pF	±5%, ±2%, ±1%	0.80	±0.10	±0.10	0.12%	
	C1608NP0240 GTS	C1608NP0240 GT	1V, 1MHz	24	pF	±5%, ±2%, ±1%	0.80	±0.10	±0.10	0.11%	
	C1608NP0270 GTS	C1608NP0270 GT	1V, 1MHz	27	pF	±5%, ±2%, ±1%	0.80	±0.10	±0.10	0.11%	
	C1608NP0300 GTS	C1608NP0300 GT	1V, 1MHz	30	pF	±5%, ±2%, ±1%	0.80	±0.10	±0.10	0.10%	
	C1608NP0330 GTS	C1608NP0330 GT	1V, 1MHz	33	pF	±5%, ±2%, ±1%	0.80	±0.10	±0.10	0.10%	
	C1608NP0360 GTS	C1608NP0360 GT	1V, 1MHz	36	pF	±5%, ±2%, ±1%	0.80	±0.10	±0.10	0.10%	
	C1608NP0390 GTS	C1608NP0390 GT	1V, 1MHz	39	pF	±5%, ±2%, ±1%	0.80	±0.10	±0.10	0.10%	
	C1608NP0430 GTS	C1608NP0430 GT	1V, 1MHz	43	pF	±5%, ±2%, ±1%	0.80	±0.10	±0.10	0.10%	
	C1608NP0470 GTS	C1608NP0470 GT	1V, 1MHz	47	pF	±5%, ±2%, ±1%	0.80	±0.10	±0.10	0.10%	
	C1608NP0560 GTS	C1608NP0560 GT	1V, 1MHz	56	pF	±5%, ±2%, ±1%	0.80	±0.10	±0.10	0.10%	
	C1608NP0620 GTS	C1608NP0620 GT	1V, 1MHz	62	pF	±5%, ±2%, ±1%	0.80	±0.10	±0.10	0.10%	
	C1608NP0680 GTS	C1608NP0680 GT	1V, 1MHz	68	pF	±5%, ±2%, ±1%	0.80	±0.10	±0.10	0.10%	
C1608NP0750 GTS	C1608NP0750 GT	1V, 1MHz	75	pF	±5%, ±2%, ±1%	0.80	±0.10	±0.10	0.10%		
C1608NP0820 GTS	C1608NP0820 GT	1V, 1MHz	82	pF	±5%, ±2%, ±1%	0.80	±0.10	±0.10	0.10%		
C1608NP0910 GTS	C1608NP0910 GT	1V, 1MHz	91	pF	±5%, ±2%, ±1%	0.80	±0.10	±0.10	0.10%		
C1608NP0101 GTS	C1608NP0101 GT	1V, 1MHz	100	pF	±5%, ±2%, ±1%	0.80	±0.10	±0.10	0.10%		
C1608NP0121 GTS	C1608NP0121 GT	1V, 1MHz	120	pF	±5%, ±2%, ±1%	0.80	±0.10	±0.10	0.10%		
C1608NP0151 GTS	C1608NP0151 GT	1V, 1MHz	150	pF	±5%, ±2%, ±1%	0.80	±0.10	±0.10	0.10%		
C1608NP0181 GTS	C1608NP0181 GT	1V, 1MHz	180	pF	±5%, ±2%, ±1%	0.80	±0.10	±0.10	0.10%		
C1608NP0201 GTS	C1608NP0201 GT	1V, 1MHz	200	pF	±5%, ±2%, ±1%	0.80	±0.10	±0.10	0.10%		
C1608NP0221 GTS	C1608NP0221 GT	1V, 1MHz	220	pF	±5%, ±2%, ±1%	0.80	±0.10	±0.10	0.10%		

RV	DARFON P/N	DARFON P/N 2	Measuring Condition	Capacitance		Available Tolerance	Thick. (mm)	Tolerance(mm)		DF (max.)	Standard Packing
				Value	Unit			L/W	Thick.		
50V	C1608NP0271 GTS	C1608NP0271 GT	1V, 1MHz	270	pF	±5%, ±2%	0.80	±0.10	±0.10	0.10%	Paper, 4Kpcs
	C1608NP0331 GTS	C1608NP0331 GT	1V, 1MHz	330	pF	±5%, ±2%	0.80	±0.10	±0.10	0.10%	
	C1608NP0391 GTS	C1608NP0391 GT	1V, 1MHz	390	pF	±5%, ±2%	0.80	±0.10	±0.10	0.10%	
	C1608NP0471 GTS	C1608NP0471 GT	1V, 1MHz	470	pF	±5%, ±2%	0.80	±0.10	±0.10	0.10%	
	C1608NP0561 GTS	C1608NP0561 GT	1V, 1MHz	560	pF	±5%, ±2%	0.80	±0.10	±0.10	0.10%	
	C1608NP0681 GTS	C1608NP0681 GT	1V, 1MHz	680	pF	±5%, ±2%	0.80	±0.10	±0.10	0.10%	
	C1608NP0821 GTS	C1608NP0821 GT	1V, 1MHz	820	pF	±5%, ±2%	0.80	±0.10	±0.10	0.10%	
	C1608NP0102 GTS	C1608NP0102 GT	1V, 1MHz	1.0	nF	±5%, ±2%	0.80	±0.10	±0.10	0.10%	
	C1608NP0122 JGTS	C1608NP0122 JGT	1V, 1kHz	1.2	nF	±5%	0.80	+0.15/-0.10	+0.15/-0.10	0.10%	
	C1608NP0152 JGTS	C1608NP0152 JGT	1V, 1kHz	1.5	nF	±5%	0.80	+0.15/-0.10	+0.15/-0.10	0.10%	
	C1608NP0182 JGTS	C1608NP0182 JGT	1V, 1kHz	1.8	nF	±5%	0.80	+0.15/-0.10	+0.15/-0.10	0.10%	
	C1608NP0222 JGTS	C1608NP0222 JGT	1V, 1kHz	2.2	nF	±5%	0.80	+0.15/-0.10	+0.15/-0.10	0.10%	
	C1608NP0272 JGTS	C1608NP0272 JGT	1V, 1kHz	2.7	nF	±5%	0.80	+0.15/-0.10	+0.15/-0.10	0.10%	
	C1608NP0332 JGTS	C1608NP0332 JGT	1V, 1kHz	3.3	nF	±5%	0.80	+0.15/-0.10	+0.15/-0.10	0.10%	
25V	C1608NP0103 JGTS	C1608NP0103 JGT	1V, 1kHz	10	nF	±5%	0.80	+0.15/-0.10	+0.15/-0.10	0.10%	Paper, 4Kpcs
	C1608NP0152 JFTS	C1608NP0152 JFT	1V, 1kHz	1.5	nF	±5%	0.80	+0.15/-0.10	+0.15/-0.10	0.10%	
	C1608NP0682 JFTS	C1608NP0682 JFT	1V, 1kHz	6.8	nF	±5%	0.80	+0.15/-0.10	+0.15/-0.10	0.10%	
16V	C1608NP0103 JFTS	C1608NP0103 JFT	1V, 1kHz	10	nF	±5%	0.80	+0.15/-0.10	+0.15/-0.10	0.10%	Paper, 4Kpcs
	C1608NP0180 ETS	C1608NP0180 ET	1V, 1MHz	18	pF	±5%, ±2%, ±1%	0.80	±0.10	±0.10	0.13%	
	C1608NP0300 JETS	C1608NP0300 JET	1V, 1MHz	30	pF	±5%	0.80	±0.10	±0.10	0.10%	
	C1608NP0272 JETS	C1608NP0272 JET	1V, 1kHz	2.7	nF	±5%	0.80	+0.15/-0.10	+0.15/-0.10	0.10%	
	C1608NP0332 JETS	C1608NP0332 JET	1V, 1kHz	3.3	nF	±5%	0.80	+0.15/-0.10	+0.15/-0.10	0.10%	

● C2012NP0_S Series (EIA0805)

RV	DARFON P/N	DARFON P/N 2	Measuring Condition	Capacitance		Available Tolerance	Thick. (mm)	Tolerance(mm)		DF (max.)	Standard Packing	
				Value	Unit			L/W	Thick.			
50V	C2012NP0100 GTS	C2012NP0100 GT	1V, 1MHz	10	pF	±5%, ±2%	0.60	±0.15	±0.15	0.17%	Paper, 4Kpcs	
	C2012NP0120 GTS	C2012NP0120 GT	1V, 1MHz	12	pF	±5%, ±2%	0.60	±0.15	±0.15	0.16%		
	C2012NP0150 GTS	C2012NP0150 GT	1V, 1MHz	15	pF	±5%, ±2%	0.60	±0.15	±0.15	0.14%		
	C2012NP0180 GTS	C2012NP0180 GT	1V, 1MHz	18	pF	±5%, ±2%	0.60	±0.15	±0.15	0.13%		
	C2012NP0200 GTS	C2012NP0200 GT	1V, 1MHz	20	pF	±5%, ±2%	0.60	±0.15	±0.15	0.13%		
	C2012NP0220 GTS	C2012NP0220 GT	1V, 1MHz	22	pF	±5%, ±2%	0.60	±0.15	±0.15	0.12%		
	C2012NP0270 GTS	C2012NP0270 GT	1V, 1MHz	27	pF	±5%, ±2%	0.60	±0.15	±0.15	0.11%		
	C2012NP0300 GTS	C2012NP0300 GT	1V, 1MHz	30	pF	±5%, ±2%	0.60	±0.15	±0.15	0.10%		
	C2012NP0330 GTS	C2012NP0330 GT	1V, 1MHz	33	pF	±5%, ±2%	0.60	±0.15	±0.15	0.10%		
	C2012NP0360 GTS	C2012NP0360 GT	1V, 1MHz	36	pF	±5%, ±2%	0.60	±0.15	±0.15	0.10%		
	C2012NP0470 GTS	C2012NP0470 GT	1V, 1MHz	47	pF	±5%, ±2%	0.60	±0.15	±0.15	0.10%		
	C2012NP0680 GTS	C2012NP0680 GT	1V, 1MHz	68	pF	±5%, ±2%	0.60	±0.15	±0.15	0.10%		
	C2012NP0820 GTS	C2012NP0820 GT	1V, 1MHz	82	pF	±5%, ±2%	0.60	±0.15	±0.15	0.10%		
	C2012NP0101 GTS	C2012NP0101 GT	1V, 1MHz	100	pF	±5%, ±2%	0.60	±0.15	±0.15	0.10%		
	C2012NP0121 JGTS	C2012NP0121 JGT	1V, 1MHz	120	pF	±5%	0.60	±0.15	±0.15	0.10%		
	C2012NP0151 JGTS	C2012NP0151 JGT	1V, 1MHz	150	pF	±5%	0.60	±0.15	±0.15	0.10%		
	C2012NP0201 JGTS	C2012NP0201 JGT	1V, 1MHz	200	pF	±5%	0.60	±0.15	±0.15	0.10%		
	C2012NP0221 JGTS	C2012NP0221 JGT	1V, 1MHz	220	pF	±5%	0.60	±0.15	±0.15	0.10%		
	C2012NP0271 JGTS	C2012NP0271 JGT	1V, 1MHz	270	pF	±5%	0.60	±0.15	±0.15	0.10%		
	C2012NP0331 JGTS	C2012NP0331 JGT	1V, 1MHz	330	pF	±5%	0.60	±0.15	±0.15	0.10%		
	C2012NP0391 JGTS	C2012NP0391 JGT	1V, 1MHz	390	pF	±5%	0.60	±0.15	±0.15	0.10%		
	C2012NP0471 JGTS	C2012NP0471 JGT	1V, 1MHz	470	pF	±5%	0.60	±0.15	±0.15	0.10%		
	C2012NP0561 JGTS	C2012NP0561 JGT	1V, 1MHz	560	pF	±5%	0.60	±0.15	±0.15	0.10%		
	C2012NP0681 JGTS	C2012NP0681 JGT	1V, 1MHz	680	pF	±5%	0.60	±0.15	±0.15	0.10%		
	C2012NP0821 JGTS	C2012NP0821 JGT	1V, 1MHz	820	pF	±5%	0.60	±0.15	±0.15	0.10%		
	C2012NP0102 JGTS	C2012NP0102 JGT	1V, 1MHz	1.0	nF	±5%	0.60	±0.15	±0.15	0.10%		
	C2012NP0122 JGTS	C2012NP0122 JGT	1V, 1kHz	1.2	nF	±5%	0.85	±0.15	±0.15	0.10%		
	C2012NP0152 JGTS	C2012NP0152 JGT	1V, 1kHz	1.5	nF	±5%	0.85	±0.15	±0.15	0.10%		
	C2012NP0182 JGTS	C2012NP0182 JGT	1V, 1kHz	1.8	nF	±5%	0.85	±0.15	±0.15	0.10%		
	C2012NP0222 JGTS	C2012NP0222 JGT	1V, 1kHz	2.2	nF	±5%	0.85	±0.15	±0.15	0.10%		
	C2012NP0272 JGTS	C2012NP0272 JGT	1V, 1kHz	2.7	nF	±5%	0.85	±0.15	±0.15	0.10%		
	C2012NP0332 JGTS	C2012NP0332 JGT	1V, 1kHz	3.3	nF	±5%	0.85	±0.15	±0.15	0.10%		
	C2012NP0392 JGTS	C2012NP0392 JGT	1V, 1kHz	3.9	nF	±5%	0.85	±0.15	±0.15	0.10%		
	C2012NP0472 JGTS	C2012NP0472 JGT	1V, 1kHz	4.7	nF	±5%	0.85	±0.15	±0.15	0.10%		
	C2012NP0272 JGPS	C2012NP0272 JGP	1V, 1kHz	2.7	nF	±5%	1.25	±0.15	±0.20	0.10%		Embossed, 3Kpcs
	C2012NP0332 JGPS	C2012NP0332 JGP	1V, 1kHz	3.3	nF	±5%	1.25	±0.15	±0.20	0.10%		
	C2012NP0392 JGPS	C2012NP0392 JGP	1V, 1kHz	3.9	nF	±5%	1.25	±0.15	±0.20	0.10%		
	C2012NP0472 JGPS	C2012NP0472 JGP	1V, 1kHz	4.7	nF	±5%	1.25	±0.15	±0.20	0.10%		
	C2012NP0562 JGPS	C2012NP0562 JGP	1V, 1kHz	5.6	nF	±5%	1.25	±0.15	±0.20	0.10%		
	C2012NP0682 JGPS	C2012NP0682 JGP	1V, 1kHz	6.8	nF	±5%	1.25	±0.15	±0.20	0.10%		
	C2012NP0822 JGPS	C2012NP0822 JGP	1V, 1kHz	8.2	nF	±5%	1.25	±0.15	±0.20	0.10%		
	C2012NP0103 JGTS	C2012NP0103 JGT	1V, 1kHz	10	nF	±5%	0.85	±0.15	±0.10	0.10%		
C2012NP0103 JGPS	C2012NP0103 JGP	1V, 1kHz	10	nF	±5%	1.25	±0.15	±0.20	0.10%	Embossed, 3Kpcs		
16V	C2012NP0270 ETS	C2012NP0270 ET	1V, 1MHz	27	pF	±5%, ±2%	0.60	±0.15	±0.15	0.11%	Paper, 4Kpcs	

□ Tolerance Code: F=±1%, G=±2%, J=±5%; Special tolerance on the request.

● C3216NP0_S Series (EIA1206)

RV	DARFON P/N	DARFON P/N 2	Measuring Condition	Capacitance		Available Tolerance	Thick. (mm)	Tolerance(mm)		DF (max.)	Standard Packing
				Value	Unit			L/W	Thick.		
50V	C3216NP0123JGPS	C3216NP0123JGP	1V, 1kHz	12	nF	±5%	1.60	±0.30	±0.30	0.10%	Embossed, 2Kpcs
	C3216NP0153JGPS	C3216NP0153JGP	1V, 1kHz	15	nF	±5%	1.60	±0.30	±0.30	0.10%	
	C3216NP0183JGPS	C3216NP0183JGP	1V, 1kHz	18	nF	±5%	1.60	±0.30	±0.30	0.10%	
	C3216NP0223JGPS	C3216NP0223JGP	1V, 1kHz	22	nF	±5%	1.60	±0.30	±0.30	0.10%	
	C3216NP0273JGPS	C3216NP0273JGP	1V, 1kHz	27	nF	±5%	1.60	±0.30	±0.30	0.10%	
	C3216NP0333JGPS	C3216NP0333JGP	1V, 1kHz	33	nF	±5%	1.60	±0.30	±0.30	0.10%	
	C3216NP0393JGPS	C3216NP0393JGP	1V, 1kHz	39	nF	±5%	1.60	±0.30	±0.30	0.10%	
	C3216NP0473JGPS	C3216NP0473JGP	1V, 1kHz	47	nF	±5%	1.15	±0.20	±0.20	0.10%	Embossed, 3Kpcs
16V	C3216NP0123JEPS	C3216NP0123JEP	1V, 1kHz	12	nF	±5%	1.60	±0.30	±0.30	0.10%	Embossed, 2Kpcs
	C3216NP0153JEPS	C3216NP0153JEP	1V, 1kHz	15	nF	±5%	1.60	±0.30	±0.30	0.10%	
	C3216NP0183JEPS	C3216NP0183JEP	1V, 1kHz	18	nF	±5%	1.60	±0.30	±0.30	0.10%	
	C3216NP0223JEPS	C3216NP0223JEP	1V, 1kHz	22	nF	±5%	1.60	±0.30	±0.30	0.10%	
	C3216NP0273JEPS	C3216NP0273JEP	1V, 1kHz	27	nF	±5%	1.60	±0.30	±0.30	0.10%	
	C3216NP0333JEPS	C3216NP0333JEP	1V, 1kHz	33	nF	±5%	1.60	±0.30	±0.30	0.10%	
	C3216NP0393JEPS	C3216NP0393JEP	1V, 1kHz	39	nF	±5%	1.60	±0.30	±0.30	0.10%	

□ Tolerance Code: F=±1%, G=±2%, J=±5%; Special tolerance on the request.

● Class II: High Dielectric Constant Type

■ Feature

1. High volumetric efficiency
2. High insulation resistance
3. RoHS compliant
4. Halogen Free

■ Application

1. Blocking
2. Coupling
3. Timing
4. Bypassing
5. Frequency discriminating
6. Flittering

■ Part Number & Characteristic

■ X5R Series

● C0603X5R Series(EIA0201)

RV	DARFON P/N	DARFON P/N 2	Measuring Condition	Capacitance		Available Tolerance	Thick. (mm)	Tolerance(mm)		DF (max.)	Standard Packing	Test Spec.		
				Value	Unit			L/W	Thick.					
50V	C0603X5R102□GTS	C0603X5R102□GT	1V, 1kHz	1.0	nF	±10%, ±20%	0.30	±0.03	±0.03	5.0%	Paper, 15Kpcs	(I)		
25V	C0603X5R102□FTS	C0603X5R102□FT	1V, 1kHz	1.0	nF	±10%, ±20%	0.30	±0.03	±0.03	5.0%	Paper, 15Kpcs	(I)*		
	C0603X5R103□FTS	C0603X5R103□FT	1V, 1kHz	10	nF	±10%, ±20%	0.30	±0.03	±0.03	5.0%		(II)*		
	C0603X5R223□FTS	C0603X5R223□FT	1V, 1kHz	22	nF	±10%, ±20%	0.30	±0.03	±0.03	7.5%		(II)*		
	C0603X5R104□FTS	C0603X5R104□FT	1V, 1kHz	100	nF	±10%, ±20%	0.30	±0.03	±0.03	10.0%		(II)*		
	C0603X5R474MFTS	C0603X5R474MFT	1V, 1kHz	470	nF	±20%	0.30	±0.09	±0.09	10.0%		(II)*		
16V	C0603X5R103□ETS	C0603X5R103□ET	1V, 1kHz	10	nF	±10%, ±20%	0.30	±0.03	±0.03	5.0%	Paper, 15Kpcs	(II)		
	C0603X5R223□ETS	C0603X5R223□ET	1V, 1kHz	22	nF	±10%, ±20%	0.30	±0.03	±0.03	10.0%		(II)*		
	C0603X5R104□ETS	C0603X5R104□ET	1V, 1kHz	100	nF	±10%, ±20%	0.30	±0.03	±0.03	10.0%		(II)		
	C0603X5R224□ETS	C0603X5R224□ET	1V, 1kHz	220	nF	±10%, ±20%	0.30	±0.03	±0.03	10.0%		(II)		
	C0603X5R105METS	C0603X5R105MET	0.5V, 1kHz	1.0	uF	±20%	0.30	±0.09	±0.09	12.5%		(II)*		
10V	C0603X5R222□DTS	C0603X5R222□DT	1V, 1kHz	2.2	nF	±10%, ±20%	0.30	±0.03	±0.03	7.5%	Paper, 15Kpcs	(I)		
	C0603X5R332□DTS	C0603X5R332□DT	1V, 1kHz	3.3	nF	±10%, ±20%	0.30	±0.03	±0.03	7.5%		(I)		
	C0603X5R472□DTS	C0603X5R472□DT	1V, 1kHz	4.7	nF	±10%, ±20%	0.30	±0.03	±0.03	7.5%		(I)		
	C0603X5R562□DTS	C0603X5R562□DT	1V, 1kHz	5.6	nF	±10%, ±20%	0.30	±0.03	±0.03	7.5%		(I)		
	C0603X5R682□DTS	C0603X5R682□DT	1V, 1kHz	6.8	nF	±10%, ±20%	0.30	±0.03	±0.03	7.5%		(I)		
	C0603X5R822□DTS	C0603X5R822□DT	1V, 1kHz	8.2	nF	±10%, ±20%	0.30	±0.03	±0.03	7.5%		(I)		
	C0603X5R103□DTS	C0603X5R103□DT	1V, 1kHz	10	nF	±10%, ±20%	0.30	±0.03	±0.03	7.5%		(I)		
	C0603X5R153□DTS	C0603X5R153□DT	1V, 1kHz	15	nF	±10%, ±20%	0.30	±0.03	±0.03	7.5%		(II)		
	C0603X5R223□DTS	C0603X5R223□DT	1V, 1kHz	22	nF	±10%, ±20%	0.30	±0.03	±0.03	7.5%		(II)		
	C0603X5R333□DTS	C0603X5R333□DT	1V, 1kHz	33	nF	±10%, ±20%	0.30	±0.03	±0.03	7.5%		(II)		
	C0603X5R473□DTS	C0603X5R473□DT	1V, 1kHz	47	nF	±10%, ±20%	0.30	±0.03	±0.03	7.5%		(II)		
	C0603X5R563□DTS	C0603X5R563□DT	1V, 1kHz	56	nF	±10%, ±20%	0.30	±0.03	±0.03	7.5%		(II)		
	C0603X5R683□DTS	C0603X5R683□DT	1V, 1kHz	68	nF	±10%, ±20%	0.30	±0.03	±0.03	7.5%		(II)		
	C0603X5R823□DTS	C0603X5R823□DT	1V, 1kHz	82	nF	±10%, ±20%	0.30	±0.03	±0.03	7.5%		(II)		
	C0603X5R104□DTS	C0603X5R104□DT	0.5V, 1kHz	100	nF	±10%, ±20%	0.30	±0.03	±0.03	10.0%		(II)		
	C0603X5R224□DTS	C0603X5R224□DT	0.5V, 1kHz	220	nF	±10%, ±20%	0.30	±0.03	±0.03	10.0%		(II)*		
	C0603X5R474□DTS	C0603X5R474□DT	0.5V, 1kHz	470	nF	±10%, ±20%	0.30	±0.03	±0.03	12.5%		(II)*		
	C0603X5R105MDTS	C0603X5R105MDT	0.5V, 1kHz	1.0	uF	±20%	0.30	±0.09	±0.09	12.5%		(II)*		
	6.3V	C0603X5R222□CTS	C0603X5R222□CT	1V, 1kHz	2.2	nF	±10%, ±20%	0.30	±0.03	±0.03		10.0%	Paper, 15Kpcs	(I)
		C0603X5R332□CTS	C0603X5R332□CT	1V, 1kHz	3.3	nF	±10%, ±20%	0.30	±0.03	±0.03		10.0%		(I)
C0603X5R472□CTS		C0603X5R472□CT	1V, 1kHz	4.7	nF	±10%, ±20%	0.30	±0.03	±0.03	10.0%	(I)			
C0603X5R562□CTS		C0603X5R562□CT	1V, 1kHz	5.6	nF	±10%, ±20%	0.30	±0.03	±0.03	10.0%	(I)			
C0603X5R682□CTS		C0603X5R682□CT	1V, 1kHz	6.8	nF	±10%, ±20%	0.30	±0.03	±0.03	10.0%	(I)			
C0603X5R822□CTS		C0603X5R822□CT	1V, 1kHz	8.2	nF	±10%, ±20%	0.30	±0.03	±0.03	10.0%	(I)			
C0603X5R103□CTS		C0603X5R103□CT	1V, 1kHz	10	nF	±10%, ±20%	0.30	±0.03	±0.03	10.0%	(I)			
C0603X5R223□CTS		C0603X5R223□CT	1V, 1kHz	22	nF	±10%, ±20%	0.30	±0.03	±0.03	10.0%	(II)			
C0603X5R333□CTS		C0603X5R333□CT	1V, 1kHz	33	nF	±10%, ±20%	0.30	±0.03	±0.03	10.0%	(II)			
C0603X5R473□CTS		C0603X5R473□CT	1V, 1kHz	47	nF	±10%, ±20%	0.30	±0.03	±0.03	10.0%	(II)			
C0603X5R563□CTS		C0603X5R563□CT	1V, 1kHz	56	nF	±10%, ±20%	0.30	±0.03	±0.03	10.0%	(II)			
C0603X5R683□CTS		C0603X5R683□CT	1V, 1kHz	68	nF	±10%, ±20%	0.30	±0.03	±0.03	10.0%	(II)			
C0603X5R823□CTS		C0603X5R823□CT	1V, 1kHz	82	nF	±10%, ±20%	0.30	±0.03	±0.03	10.0%	(II)			
C0603X5R104□CTS		C0603X5R104□CT	0.5V, 1kHz	100	nF	±10%, ±20%	0.30	±0.03	±0.03	10.0%	(II)			
C0603X5R224□CTS		C0603X5R224□CT	0.5V, 1kHz	220	nF	±10%, ±20%	0.30	±0.03	±0.03	10.0%	(II)*			
C0603X5R334□CTS		C0603X5R334□CT	0.5V, 1kHz	330	nF	±10%, ±20%	0.30	±0.03	±0.03	10.0%	(II)*			
C0603X5R474□CTS		C0603X5R474□CT	0.5V, 1kHz	470	nF	±10%, ±20%	0.30	±0.03	±0.03	12.5%	(II)*			
C0603X5R105□CTS		C0603X5R105□CT	0.5V, 1kHz	1.0	uF	±10%, ±20%	0.30	±0.05	±0.05	12.5%	(II)*			
C0603X5R225MCTS		C0603X5R225MCT	0.5V, 1kHz	2.2	uF	±20%	0.30	±0.09	±0.09	20.0%	(II)*			
4V		C0603X5R224□BTS	C0603X5R224□BT	0.5V, 1kHz	220	nF	±10%, ±20%	0.30	±0.03	±0.03	10.0%	Paper, 15Kpcs		(II)
	C0603X5R474□BTS	C0603X5R474□BT	0.5V, 1kHz	470	nF	±10%, ±20%	0.30	±0.03	±0.03	12.5%	(II)*			
	C0603X5R105□BTS	C0603X5R105□BT	0.5V, 1kHz	1.0	uF	±10%, ±20%	0.30	±0.05	±0.05	10.0%	(II)*			

● C1005X5R Series (EIA0402)

RV	DARFON P/N	DARFON P/N 2	Measuring Condition	Capacitance		Available Tolerance	Thick. (mm)	Tolerance(mm)		DF (max.)	Standard Packing	Test Spec.
				Value	Unit			L/W	Thick.			
50V	C1005X5R103KGTS	C1005X5R103KGT	1V, 1kHz	10	nF	±10%	0.50	±0.05	±0.05	5.0%	Paper, 10Kpcs	(I)
	C1005X5R473KGTS	C1005X5R473KGT	1V, 1kHz	47	nF	±10%	0.50	±0.05	±0.05	5.0%		(I)
	C1005X5R104□GTS	C1005X5R104□GT	1V, 1kHz	100	nF	±10%, ±20%	0.50	±0.05	±0.05	10.0%		(II)
	C1005X5R474□GTS	C1005X5R474□GT	1V, 1kHz	470	nF	±10%, ±20%	0.50	±0.10	±0.10	10.0%		(II)
	C1005X5R105KGTS	C1005X5R105KGT	1V, 1kHz	1	uF	±10%	0.50	±0.20	±0.20	10.0%		(II)
35V	C1005X5R105□NTS	C1005X5R105□NT	1V, 1kHz	1.0	uF	±10%, ±20%	0.50	±0.10	±0.10	10.0%	Paper, 10Kpcs	(II)*
	C1005X5R225KNTS	C1005X5R225KNNT	1V, 1kHz	2.2	uF	±10%	0.50	±0.10	±0.10	10.0%		(II)*

RV	DARFON P/N	DARFON P/N 2	Measuring Condition	Capacitance		Available Tolerance	Thick. (mm)	Tolerance(mm)		DF (max.)	Standard Packing	Test Spec.	
				Value	Unit			L/W	Thick.				
25V	C1005X5R103KFTS	C1005X5R103KFT	1V, 1kHz	10	nF	±10%	0.50	±0.05	±0.05	5.0%	Paper, 10Kpcs	(I)	
	C1005X5R223KFTS	C1005X5R223KFT	1V, 1kHz	22	nF	±10%	0.50	±0.05	±0.05	5.0%		(I)	
	C1005X5R473KFTS	C1005X5R473KFT	1V, 1kHz	47	nF	±10%	0.50	±0.05	±0.05	5.0%		(I)	
	C1005X5R683KFTS	C1005X5R683KFT	1V, 1kHz	68	nF	±10%	0.50	±0.05	±0.05	5.0%		(I)	
	C1005X5R104□FTS	C1005X5R104□FT	1V, 1kHz	100	nF	±10%, ±20%	0.50	±0.05	±0.05	5.0%		(I)	
	C1005X5R224□FTS	C1005X5R224□FT	1V, 1kHz	220	nF	±10%, ±20%	0.50	±0.05	±0.05	10.0%		(II)	
	C1005X5R474□FTS	C1005X5R474□FT	1V, 1kHz	470	nF	±10%, ±20%	0.50	±0.05	±0.05	12.5%		(II)	
16V	C1005X5R105□FTS	C1005X5R105□FT	1V, 1kHz	1.0	uF	±10%, ±20%	0.50	±0.10	±0.10	12.5%	Paper, 10Kpcs	(II)*	
	C1005X5R225□FTS	C1005X5R225□FT	1V, 1kHz	2.2	uF	±10%, ±20%	0.50	±0.20	±0.20	10.0%		(II)	
	C1005X5R153□ETS	C1005X5R153□ET	1V, 1kHz	15	nF	±10%, ±20%	0.50	±0.05	±0.05	5.0%		(I)	
	C1005X5R223□ETS	C1005X5R223□ET	1V, 1kHz	22	nF	±10%, ±20%	0.50	±0.05	±0.05	5.0%		(I)	
	C1005X5R333□ETS	C1005X5R333□ET	1V, 1kHz	33	nF	±10%, ±20%	0.50	±0.05	±0.05	5.0%		(I)	
	C1005X5R473□ETS	C1005X5R473□ET	1V, 1kHz	47	nF	±10%, ±20%	0.50	±0.05	±0.05	5.0%		(I)	
	C1005X5R563□ETS	C1005X5R563□ET	1V, 1kHz	56	nF	±10%, ±20%	0.50	±0.05	±0.05	5.0%		(I)	
	C1005X5R683□ETS	C1005X5R683□ET	1V, 1kHz	68	nF	±10%, ±20%	0.50	±0.05	±0.05	5.0%		(I)	
	C1005X5R823□ETS	C1005X5R823□ET	1V, 1kHz	82	nF	±10%, ±20%	0.50	±0.05	±0.05	5.0%		(I)	
	C1005X5R104□ETS	C1005X5R104□ET	1V, 1kHz	100	nF	±10%, ±20%	0.50	±0.05	±0.05	5.0%		(I)	
	C1005X5R124□ETS	C1005X5R124□ET	1V, 1kHz	120	nF	±10%, ±20%	0.50	±0.05	±0.05	7.5%		(II)	
	C1005X5R154□ETS	C1005X5R154□ET	1V, 1kHz	150	nF	±10%, ±20%	0.50	±0.05	±0.05	7.5%		(II)	
	C1005X5R184□ETS	C1005X5R184□ET	1V, 1kHz	180	nF	±10%, ±20%	0.50	±0.05	±0.05	7.5%		(II)	
	C1005X5R224□ETS	C1005X5R224□ET	1V, 1kHz	220	nF	±10%, ±20%	0.50	±0.05	±0.05	10.0%		(II)	
	C1005X5R474□ETS	C1005X5R474□ET	1V, 1kHz	470	nF	±10%, ±20%	0.50	±0.10	±0.10	12.5%		(II)	
10V	C1005X5R684□ETS	C1005X5R684□ET	1V, 1kHz	680	nF	±10%, ±20%	0.50	±0.05	±0.05	12.5%	Paper, 10Kpcs	(II)	
	C1005X5R105□ETS	C1005X5R105□ET	1V, 1kHz	1.0	uF	±10%, ±20%	0.50	±0.05	±0.05	12.5%		(II)	
	C1005X5R225□ETS	C1005X5R225□ET	1V, 1kHz	2.2	uF	±10%, ±20%	0.50	±0.20	±0.20	12.5%		(II)*	
	C1005X5R475METS	C1005X5R475MET	1V, 1kHz	4.7	uF	±20%	0.50	±0.20	±0.20	12.5%		(II)*	
	C1005X5R153□DTS	C1005X5R153□DT	1V, 1kHz	15	nF	±10%, ±20%	0.50	±0.05	±0.05	7.5%		Paper, 10Kpcs	(I)
	C1005X5R223□DTS	C1005X5R223□DT	1V, 1kHz	22	nF	±10%, ±20%	0.50	±0.05	±0.05	7.5%			(I)
	C1005X5R333□DTS	C1005X5R333□DT	1V, 1kHz	33	nF	±10%, ±20%	0.50	±0.05	±0.05	7.5%			(I)
	C1005X5R473□DTS	C1005X5R473□DT	1V, 1kHz	47	nF	±10%, ±20%	0.50	±0.05	±0.05	7.5%			(I)
	C1005X5R563□DTS	C1005X5R563□DT	1V, 1kHz	56	nF	±10%, ±20%	0.50	±0.05	±0.05	7.5%			(I)
	C1005X5R683□DTS	C1005X5R683□DT	1V, 1kHz	68	nF	±10%, ±20%	0.50	±0.05	±0.05	7.5%			(I)
	C1005X5R823□DTS	C1005X5R823□DT	1V, 1kHz	82	nF	±10%, ±20%	0.50	±0.05	±0.05	7.5%			(I)
	C1005X5R104□DTS	C1005X5R104□DT	1V, 1kHz	100	nF	±10%, ±20%	0.50	±0.05	±0.05	7.5%			(I)
	C1005X5R124□DTS	C1005X5R124□DT	1V, 1kHz	120	nF	±10%, ±20%	0.50	±0.05	±0.05	7.5%			(II)
C1005X5R154□DTS	C1005X5R154□DT	1V, 1kHz	150	nF	±10%, ±20%	0.50	±0.05	±0.05	7.5%	(II)			
C1005X5R184□DTS	C1005X5R184□DT	1V, 1kHz	180	nF	±10%, ±20%	0.50	±0.05	±0.05	7.5%	(II)			
C1005X5R224□DTS	C1005X5R224□DT	1V, 1kHz	220	nF	±10%, ±20%	0.50	±0.05	±0.05	7.5%	(II)			
C1005X5R334□DTS	C1005X5R334□DT	1V, 1kHz	330	nF	±10%, ±20%	0.50	±0.05	±0.05	10.0%	(II)			
6.3V	C1005X5R394□DTS	C1005X5R394□DT	1V, 1kHz	390	nF	±10%, ±20%	0.50	±0.05	±0.05	10.0%	Paper, 10Kpcs	(II)	
	C1005X5R474□DTS	C1005X5R474□DT	1V, 1kHz	470	nF	±10%, ±20%	0.50	±0.05	±0.05	10.0%		(II)	
	C1005X5R684□DTS	C1005X5R684□DT	1V, 1kHz	680	nF	±10%, ±20%	0.50	±0.05	±0.05	10.0%		(II)	
	C1005X5R105□DTS	C1005X5R105□DT	1V, 1kHz	1.0	uF	±10%, ±20%	0.50	±0.05	±0.05	10.0%		(II)	
	C1005X5R225□DTS	C1005X5R225□DT	0.5V, 1kHz	2.2	uF	±10%, ±20%	0.50	±0.05	±0.05	10.0%		(II)*	
	C1005X5R475□DTS	C1005X5R475□DT	1V, 1kHz	4.7	uF	±10%, ±20%	0.50	±0.15	±0.15	12.5%		(II)*	
	C1005X5R106MDTS	C1005X5R106MDT	0.5V, 1kHz	10	uF	±20%	0.50	±0.20	±0.20	12.5%		(II)*	
	C1005X5R223KCTS	C1005X5R223KCT	1V, 1kHz	22	nF	±10%	0.50	±0.05	±0.05	7.5%		Paper, 10Kpcs	(I)
	C1005X5R224□CTS	C1005X5R224□CT	1V, 1kHz	220	nF	±10%, ±20%	0.50	±0.05	±0.05	10.0%			(II)
	C1005X5R334□CTS	C1005X5R334□CT	1V, 1kHz	330	nF	±10%, ±20%	0.50	±0.05	±0.05	10.0%			(II)
	C1005X5R474□CTS	C1005X5R474□CT	1V, 1kHz	470	nF	±10%, ±20%	0.50	±0.05	±0.05	10.0%			(II)
	C1005X5R684□CTS	C1005X5R684□CT	1V, 1kHz	680	nF	±10%, ±20%	0.50	±0.05	±0.05	10.0%			(II)
	C1005X5R105MCTSA		1V, 1kHz	1.0	uF	±20%	0.30	±0.05	±0.03	12.5%			Paper, 15Kpcs
C1005X5R105□CTS	C1005X5R105□CT	0.5V, 1kHz	1.0	uF	±10%, ±20%	0.50	±0.05	±0.05	12.5%	Paper, 10Kpcs	(II)		
C1005X5R225MCTSA		0.5V, 1kHz	2.2	uF	±20%	0.30	±0.05	±0.03	10.0%	Paper, 15Kpcs	(II)*		
C1005X5R225□CTS	C1005X5R225□CT	0.5V, 1kHz	2.2	uF	±10%, ±20%	0.50	±0.05	±0.05	10.0%	Paper, 10Kpcs	(II)*		
C1005X5R475MCTSA		0.5V, 1kHz	4.7	uF	±20%	0.30	±0.20	±0.03	10.0%	Paper, 15Kpcs	(II)*		
C1005X5R475□CTS	C1005X5R475□CT	0.5V, 1kHz	4.7	uF	±10%, ±20%	0.50	±0.15	±0.15	10.0%	Paper, 15Kpcs	(II)*		
C1005X5R106MCTS	C1005X5R106MCT	0.5V, 1kHz	10	uF	±20%	0.50	±0.20	±0.20	15.0%	Paper, 10Kpcs	(II)*		
C1005X5R226MCTS	C1005X5R226MCT	0.5V, 120Hz	22	uF	±20%	0.50	±0.20	±0.20	15.0%	Paper, 10Kpcs	(II)*		
4V	C1005X5R105□BTS	C1005X5R105□BT	1V, 1kHz	1.0	uF	±10%, ±20%	0.50	±0.05	±0.05	15.0%	Paper, 10Kpcs	(II)	
	C1005X5R225□BTS	C1005X5R225□BT	0.5V, 1kHz	2.2	uF	±10%, ±20%	0.50	±0.05	±0.05	10.0%		(II)	
	C1005X5R225MBTSA		0.5V, 1kHz	2.2	uF	±20%	0.30	±0.05	±0.03	10.0%		Paper, 15Kpcs	(II)
	C1005X5R475□BTS	C1005X5R475□BT	0.5V, 1kHz	4.7	uF	±10%, ±20%	0.50	±0.15	±0.15	10.0%		Paper, 15Kpcs	(II)
	C1005X5R106MBTS	C1005X5R106MBT	0.5V, 1kHz	10	uF	±20%	0.50	±0.20	±0.20	15.0%	Paper, 10Kpcs	(II)	

□ Tolerance Code: K=±10%, M=±20% ;Special tolerance on the request.

(II)* High temperature load life test are applicable in rated voltage *100%

● C1608X5R Series (EIA0603)

RV	DARFON P/N	DARFON P/N 2	Measuring Condition	Capacitance		Available Tolerance	Thick. (mm)	Tolerance(mm)		DF (max.)	Standard Packing	Test Spec.
				Value	Unit			L/W	Thick.			
50V	C1608X5R102KGTS	C1608X5R102KGT	1V, 1kHz	1.0	nF	±10%	0.80	±0.10	±0.10	5.0%	Paper, 4Kpcs	(I)
	C1608X5R103KGT	C1608X5R103KGT	1V, 1kHz	10	nF	±10%	0.80	±0.10	±0.10	5.0%		(I)
	C1608X5R333KGT	C1608X5R333KGT	1V, 1kHz	33	nF	±10%	0.80	±0.15	±0.15	5.0%		(II)
	C1608X5R224KGT	C1608X5R224KGT	1V, 1kHz	220	nF	±10%	0.80	±0.15	±0.15	5.0%		(II)
	C1608X5R474□GTS	C1608X5R474□GT	1V, 1kHz	470	nF	±10%, ±20%	0.80	±0.15	±0.15	10.0%		(II)
	C1608X5R105□GTS	C1608X5R105□GT	1V, 1kHz	1.0	uF	±10%, ±20%	0.80	±0.10	±0.10	10.0%		(II)
35V	C1608X5R225□GTS	C1608X5R225□GT	1V, 1kHz	2.2	uF	±10%, ±20%	0.80	±0.20	±0.20	10.0%	Paper, 4Kpcs	(II)
	C1608X5R105□NTS	C1608X5R105□NT	1V, 1kHz	1.0	uF	±10%, ±20%	0.80	±0.10	±0.10	10.0%		(II)*
	C1608X5R475□NTS	C1608X5R475□NT	1V, 1kHz	4.7	uF	±10%, ±20%	0.80	±0.20	±0.20	10.0%		(II)*
	C1608X5R106MNTS	C1608X5R106MNT	1V, 1kHz	10	uF	±20%	0.80	±0.20	±0.20	10.0%		(II)*
	C1608X5R104□FTS	C1608X5R104□FT	1V, 1kHz	100	nF	±10%, ±20%	0.80	±0.10	±0.10	5.0%		(I)
	C1608X5R224□FTS	C1608X5R224□FT	1V, 1kHz	220	nF	±10%, ±20%	0.80	±0.10	±0.10	5.0%		(I)
25V	C1608X5R334KFTS	C1608X5R334KFT	1V, 1kHz	330	nF	±10%	0.80	±0.15	±0.15	7.5%	Paper, 4Kpcs	(I)
	C1608X5R474□FTS	C1608X5R474□FT	1V, 1kHz	470	nF	±10%, ±20%	0.80	±0.10	±0.10	5.0%		(II)
	C1608X5R105□FTS	C1608X5R105□FT	1V, 1kHz	1.0	uF	±10%, ±20%	0.80	±0.15	±0.15	10.0%		(II)
	C1608X5R105□FTSB		1V, 1kHz	1.0	uF	±10%, ±20%	0.50	±0.10	+0/-0.10	12.5%		(II)*
	C1608X5R225□FTS	C1608X5R225□FT	1V, 1kHz	2.2	uF	±10%, ±20%	0.80	±0.15	±0.15	10.0%		(II)
	C1608X5R475□FTS	C1608X5R475□FT	1V, 1kHz	4.7	uF	±10%, ±20%	0.80	±0.20	±0.20	10.0%		(II)
	C1608X5R106MFTS	C1608X5R106MFT	1V, 1kHz	10	uF	±20%	0.80	±0.20	±0.20	10.0%		(II)
	C1608X5R104□ETS	C1608X5R104□ET	1V, 1kHz	100	nF	±10%, ±20%	0.80	±0.10	±0.10	5.0%		(I)
	C1608X5R224□ETS	C1608X5R224□ET	1V, 1kHz	220	nF	±10%, ±20%	0.80	±0.10	±0.10	5.0%		(I)
	C1608X5R334□ETS	C1608X5R334□ET	1V, 1kHz	330	nF	±10%, ±20%	0.80	±0.10	±0.10	5.0%		(I)
	C1608X5R474□ETS	C1608X5R474□ET	1V, 1kHz	470	nF	±10%, ±20%	0.80	±0.10	±0.10	3.5%		(II)
	C1608X5R684□ETS	C1608X5R684□ET	1V, 1kHz	680	nF	±10%, ±20%	0.80	±0.10	±0.10	7.5%		(II)
16V	C1608X5R105□ETS	C1608X5R105□ET	1V, 1kHz	1.0	uF	±10%, ±20%	0.80	±0.10	±0.10	10.0%	Paper, 4Kpcs	(II)
	C1608X5R105□ETSB		0.5V, 1kHz	1.0	uF	±10%, ±20%	0.50	±0.10	+0/-0.10	10.0%		(II)
	C1608X5R225□ETS	C1608X5R225□ET	1V, 1kHz	2.2	uF	±10%, ±20%	0.80	±0.10	±0.10	10.0%		(II)
	C1608X5R475□ETS	C1608X5R475□ET	1V, 1kHz	4.7	uF	±10%, ±20%	0.80	±0.20	±0.15	10.0%		(II)*
	C1608X5R106□ETS	C1608X5R106□ET	1V, 1kHz	10	uF	±10%, ±20%	0.80	±0.20	±0.20	10.0%		(II)*
	C1608X5R104□DTS	C1608X5R104□DT	1V, 1kHz	100	nF	±10%, ±20%	0.80	±0.10	±0.10	7.5%		(I)
	C1608X5R224□DTS	C1608X5R224□DT	1V, 1kHz	220	nF	±10%, ±20%	0.80	±0.10	±0.10	7.5%		(I)
	C1608X5R334□DTS	C1608X5R334□DT	1V, 1kHz	330	nF	±10%, ±20%	0.80	±0.10	±0.10	7.5%		(I)
	C1608X5R474□DTS	C1608X5R474□DT	1V, 1kHz	470	nF	±10%, ±20%	0.80	±0.10	±0.10	7.5%		(I)
	C1608X5R684□DTS	C1608X5R684□DT	1V, 1kHz	680	nF	±10%, ±20%	0.80	±0.10	±0.10	7.5%		(I)
	C1608X5R105□DTS	C1608X5R105□DT	1V, 1kHz	1.0	uF	±10%, ±20%	0.80	±0.10	±0.10	7.5%		(II)
	C1608X5R105□DTSB		1V, 1kHz	1.0	uF	±10%, ±20%	0.50	±0.10	+0/-0.10	10.0%		(II)
10V	C1608X5R225□DTS	C1608X5R225□DT	1V, 1kHz	2.2	uF	±10%, ±20%	0.80	±0.10/±0.15	±0.15	10.0%	Paper, 4Kpcs	(II)
	C1608X5R225□DTSB		0.5V, 1kHz	2.2	uF	±10%, ±20%	0.50	±0.10	+0/-0.10	10.0%		(II)*
	C1608X5R335□DTS	C1608X5R335□DT	1V, 1kHz	3.3	uF	±10%, ±20%	0.80	±0.15	±0.15	10.0%		(II)
	C1608X5R475□DTS	C1608X5R475□DT	1V, 1kHz	4.7	uF	±10%, ±20%	0.80	±0.15	±0.15	10.0%		(II)
	C1608X5R475□DTSB		1V, 1kHz	4.7	uF	±10%, ±20%	0.50	±0.20	±0.05	10.0%		(II)
	C1608X5R106□DTS	C1608X5R106□DT	1V, 1kHz	10	uF	±10%, ±20%	0.80	±0.20	±0.20	10.0%		(II)*
	C1608X5R226MDTS	C1608X5R226MDT	0.5V, 120Hz	22	uF	±20%	0.80	±0.20	±0.20	10.0%		(II)*
	C1608X5R226MDWS	C1608X5R226MDW	0.5V, 120Hz	22	uF	±20%	0.80	±0.20	±0.20	10.0%		(II)*
	C1608X5R104□CTS	C1608X5R104□CT	1V, 1kHz	100	nF	±10%, ±20%	0.80	±0.10	±0.10	7.5%		(I)
	C1608X5R105□CTS	C1608X5R105□CT	1V, 1kHz	1.0	uF	±10%, ±20%	0.80	±0.10	±0.10	7.5%		(II)
	C1608X5R225□CTS	C1608X5R225□CT	0.5V, 1kHz	2.2	uF	±10%, ±20%	0.80	±0.10	±0.10	10.0%		(II)
	C1608X5R335KCTS	C1608X5R335KCT	1V, 1kHz	3.3	uF	±10%	0.80	±0.15	±0.15	10.0%		(II)
6.3V	C1608X5R475□CTS	C1608X5R475□CT	0.5V, 1kHz	4.7	uF	±10%, ±20%	0.80	±0.10	±0.10	10.0%	Paper, 4Kpcs	(II)
	C1608X5R106MCTS		0.5V, 1kHz	10	uF	±20%	0.50	±0.10	±0.10	10.0%		(II)*
	C1608X5R106□CTS	C1608X5R106□CT	0.5V, 1kHz	10	uF	±10%, ±20%	0.80	±0.15	±0.15	10.0%		(II)*
	C1608X5R226MCTS	C1608X5R226MCT	0.5V, 120Hz	22	uF	±20%	0.80	±0.20	±0.20	15.0%		(II)*
	C1608X5R476MCTS	C1608X5R476MCT	0.5V, 120Hz	47	uF	±20%	0.80	±0.20	±0.20	12.5%		(II)*
	C1608X5R106MBTS	C1608X5R106MBT	0.5V, 1kHz	10	uF	±20%	0.80	±0.10	±0.10	10.0%		(II)
4V	C1608X5R226MBTS	C1608X5R226MBT	0.5V, 120Hz	22	uF	±20%	0.80	±0.20	±0.20	10.0%	Paper, 4Kpcs	(II)*
	C1608X5R476MBTS	C1608X5R476MBT	0.5V, 120Hz	47	uF	±20%	0.80	±0.20	±0.20	12.5%		(II)*

● C2012X5R Series (EIA0805)

RV	DARFON P/N	DARFON P/N 2	Measuring Condition	Capacitance		Available Tolerance	Thick. (mm)	Tolerance(mm)		DF (max.)	Standard Packing	Test Spec.	
				Value	Unit			L/W	Thick.				
50V	C2012X5R105□GTS	C2012X5R105□GT	1V, 1kHz	1.0	uF	±10%, ±20%	0.85	±0.15	±0.15	10.0%	Paper, 4Kpcs	(II)	
	C2012X5R225□GTS	C2012X5R225□GT	1V, 1kHz	2.2	uF	±10%, ±20%	0.85	±0.20	±0.15	10.0%		(II)	
	C2012X5R105□GPS	C2012X5R105□GP	1V, 1kHz	1.0	uF	±10%, ±20%	1.25	±0.15	±0.20	10.0%		(II)	
	C2012X5R225□GPS	C2012X5R225□GP	1V, 1kHz	2.2	uF	±10%, ±20%	1.25	±0.15	±0.20	10.0%		(II)	
	C2012X5R475□GPS	C2012X5R475□GP	1V, 1kHz	4.7	uF	±10%, ±20%	1.25	±0.20	±0.20	10.0%		(II)	
	C2012X5R106MGPS	C2012X5R106MGP	1V, 1kHz	10.0	uF	±20%	1.25	±0.20	±0.20	10.0%		(II)*	
35V	C2012X5R106KNPS	C2012X5R106KNP	1V, 1kHz	10.0	uF	±10%	1.25	±0.20	±0.20	10.0%	Embossed, 3Kpcs	(II)*	
25V	C2012X5R105□FTS	C2012X5R105□FT	1V, 1kHz	1.0	uF	±10%, ±20%	0.85	±0.15	±0.10	10.0%	Paper, 4Kpcs	(II)	
	C2012X5R105□FPS	C2012X5R105□FP	1V, 1kHz	1.0	uF	±10%, ±20%	1.25	±0.20	±0.20	10.0%		Embossed, 3Kpcs	(I)
	C2012X5R225□FTS	C2012X5R225□FT	1V, 1kHz	2.2	uF	±10%, ±20%	0.85	±0.20	±0.10	10.0%	Paper, 4Kpcs	(II)	
	C2012X5R225□FPS	C2012X5R225□FP	1V, 1kHz	2.2	uF	±10%, ±20%	1.25	±0.15	±0.20	10.0%		Embossed, 3Kpcs	(II)
	C2012X5R475□FTS	C2012X5R475□FT	1V, 1kHz	4.7	uF	±10%, ±20%	0.85	±0.20	±0.10	10.0%	Paper, 4Kpcs	(II)*	
	C2012X5R475□FPS	C2012X5R475□FP	1V, 1kHz	4.7	uF	±10%, ±20%	1.25	±0.15	±0.20	10.0%		Embossed, 3Kpcs	(II)
	C2012X5R106□FTS	C2012X5R106□FT	1V, 1kHz	10	uF	±10%, ±20%	0.85	±0.20	±0.10	12.5%	Paper, 4Kpcs	(II)*	
	C2012X5R106□FPS	C2012X5R106□FP	1V, 1kHz	10	uF	±10%, ±20%	1.25	±0.20	±0.20	12.5%		Embossed, 3Kpcs	(II)*
		C2012X5R226MFPS	C2012X5R226MFP	0.5V, 120Hz	22	uF	±20%	1.25	±0.20	±0.20	15.0%	Embossed, 3Kpcs	(II)

□ Tolerance Code: K=±10%, M=±20% ;(II)* High temperature load life test are applicable in rated voltage *100%

RV	DARFON P/N	DARFON P/N 2	Measuring Condition	Capacitance		Available Tolerance	Thick. (mm)	Tolerance(mm)		DF (max.)	Standard Packing	Test Spec.
				Value	Unit			L/W	Thick.			
16V	C2012X5R105 ETS	C2012X5R105 ET	1V, 1kHz	1.0	uF	±10%, ±20%	0.85	±0.15	±0.15	10.0%	Paper, 4Kpcs	(II)
	C2012X5R105 EPS	C2012X5R105 EP	1V, 1kHz	1.0	uF	±10%, ±20%	1.25	±0.15	±0.20	5.0%	Embossed, 3Kpcs	(I)
	C2012X5R225 EPS	C2012X5R225 EP	1V, 1kHz	2.2	uF	±10%, ±20%	1.25	±0.15	±0.20	5.0%		(II)
	C2012X5R335 EPS	C2012X5R335 EP	1V, 1kHz	3.3	uF	±10%, ±20%	1.25	±0.20	±0.20	10.0%		(II)
	C2012X5R475 ETS	C2012X5R475 ET	0.5V, 1kHz	4.7	uF	±10%, ±20%	0.85	±0.20	±0.10	10.0%		Paper, 4Kpcs
	C2012X5R475 EPS	C2012X5R475 EP	1V, 1kHz	4.7	uF	±10%, ±20%	1.25	±0.15	±0.20	7.5%	Embossed, 3Kpcs	(II)
	C2012X5R106 ETS	C2012X5R106 ET	1V, 1kHz	10	uF	±10%, ±20%	0.85	±0.15	±0.10	10.0%	Paper, 4Kpcs	(II)*
	C2012X5R106 EPS	C2012X5R106 EP	0.5V, 1kHz	10	uF	±10%, ±20%	1.25	±0.15	±0.20	10.0%	Embossed, 3Kpcs	(II)*
C2012X5R226METS	C2012X5R226MET	0.5V, 120Hz	22	uF	±20%	0.85	±0.20	±0.10	10.0%	Paper, 4Kpcs	(II)*	
10V	C2012X5R226MEPS	C2012X5R226MEP	0.5V, 120Hz	22	uF	±20%	1.25	±0.20	±0.20	10.0%	Embossed, 3Kpcs	(II)*
	C2012X5R225 DTS	C2012X5R225 DT	1V, 1kHz	2.2	uF	±10%, ±20%	0.85	±0.15	±0.10	10.0%	Paper, 4Kpcs	(II)
	C2012X5R335 DPS	C2012X5R335 DP	1V, 1kHz	3.3	uF	±10%, ±20%	1.25	±0.20	±0.20	10.0%	Embossed, 3Kpcs	(II)
	C2012X5R475 DPS	C2012X5R475 DP	1V, 1kHz	4.7	uF	±10%, ±20%	1.25	±0.15	±0.20	10.0%		(II)
	C2012X5R106 DTS	C2012X5R106 DT	0.5V, 1kHz	10	uF	±10%, ±20%	0.85	±0.20	±0.15	10.0%	Paper, 4Kpcs	(II)
	C2012X5R106 DPS	C2012X5R106 DP	0.5V, 1kHz	10	uF	±10%, ±20%	1.25	±0.15	±0.20	10.0%	Embossed, 3Kpcs	(II)
	C2012X5R226MDTS	C2012X5R226MDT	0.5V, 120Hz	22	uF	±20%	0.85	±0.20	±0.15	10.0%	Paper, 4Kpcs	(II)*
	C2012X5R226MDPS	C2012X5R226MDP	0.5V, 120Hz	22	uF	±20%	1.25	±0.20	±0.20	15.0%	Embossed, 3Kpcs	(II)*
C2012X5R476MDPS	C2012X5R476MDP	0.5V, 120Hz	47	uF	±20%	1.25	±0.20	±0.20	10.0%	(II)*		
6.3V	C2012X5R225KCTS	C2012X5R225KCT	1V, 1kHz	2.2	uF	±10%	0.85	±0.15	±0.10	10.0%	Paper, 4Kpcs	(II)
	C2012X5R475 CPS	C2012X5R475 CP	0.5V, 1kHz	4.7	uF	±10%, ±20%	1.25	±0.15	±0.20	10.0%	Embossed, 3Kpcs	(I)
	C2012X5R106 CTS	C2012X5R106 CT	0.5V, 1kHz	10	uF	±10%, ±20%	0.85	±0.20	±0.15	10.0%	Paper, 4Kpcs	(II)
	C2012X5R106 CPS	C2012X5R106 CP	0.5V, 1kHz	10	uF	±10%, ±20%	1.25	±0.15	±0.20	10.0%	Embossed, 3Kpcs	(II)
	C2012X5R226MCTS	C2012X5R226MCT	0.5V, 120Hz	22	uF	±20%	0.85	±0.15	±0.15	10.0%	Paper, 4Kpcs	(II)
	C2012X5R226 CPS	C2012X5R226 CP	0.5V, 120Hz	22	uF	±10%, ±20%	1.25	±0.15	±0.15	10.0%	Embossed, 3Kpcs	(II)
	C2012X5R476MCTS	C2012X5R476MCT	0.5V, 120Hz	47	uF	±20%	0.85	±0.20	±0.15	10.0%	Paper, 4Kpcs	(II)*
	C2012X5R476MCP	C2012X5R476MCP	0.5V, 120Hz	47	uF	±20%	1.25	±0.20	±0.20	10.0%	Embossed, 3Kpcs	(II)*
4V	C2012X5R107MCP	C2012X5R107MCP	0.5V, 120Hz	100	uF	±20%	1.25	±0.20	±0.20	10.0%	Embossed, 3Kpcs	(II)*
	C2012X5R107MBPS	C2012X5R107MBP	0.5V, 120Hz	100	uF	±20%	1.25	±0.20	±0.20	10.0%	Embossed, 3Kpcs	(II)*

● C3216X5R Series (EIA1206)

RV	DARFON P/N	DARFON P/N 2	Measuring Condition	Capacitance		Available Tolerance	Thick. (mm)	Tolerance(mm)		DF (max.)	Standard Packing	Test Spec.
				Value	Unit			L/W	Thick.			
50V	C3216X5R225 GTS	C3216X5R225 GT	1V, 1kHz	2.2	uF	±10%, ±20%	0.85	±0.15	±0.10	10.0%	Paper, 4Kpcs	(II)
	C3216X5R475 GTS	C3216X5R475 GT	1V, 1kHz	4.7	uF	±10%, ±20%	0.85	±0.15	±0.10	10.0%		(II)
	C3216X5R475 GPS	C3216X5R475 GP	1V, 1kHz	4.7	uF	±10%, ±20%	1.60	±0.20	±0.30	10.0%	Embossed, 2Kpcs	(II)
	C3216X5R106 GPS	C3216X5R106 GP	1V, 1kHz	10	uF	±10%, ±20%	1.60	±0.20	±0.20	10.0%		(II)
35V	C3216X5R106 NTS	C3216X5R106 NT	1V, 1kHz	10	uF	±10%, ±20%	0.85	±0.15	±0.10	10.0%	Paper, 4Kpcs	(II)*
	C3216X5R106 NPS	C3216X5R106 NP	1V, 1kHz	10	uF	±10%, ±20%	1.60	±0.20	±0.30	10.0%	Embossed, 2Kpcs	(II)
25V	C3216X5R105KFTSE	C3216X5R105KFT	1V, 1kHz	1.0	uF	±10%	0.85	±0.15	±0.10	3.5%	Paper, 4Kpcs	(I)
	C3216X5R225 FPS	C3216X5R225 FP	1V, 1kHz	2.2	uF	±10%, ±20%	1.60	±0.20	±0.30	5.0%	Embossed, 2Kpcs	(I)
	C3216X5R475 FPS	C3216X5R475 FP	1V, 1kHz	4.7	uF	±10%, ±20%	1.60	±0.20	±0.30	5.0%		(I)
	C3216X5R106 FPS	C3216X5R106 FP	1V, 1kHz	10	uF	±10%, ±20%	1.60	±0.20	±0.30	10.0%	(II)	
	C3216X5R226MFTSE	C3216X5R226MFT	0.5V, 120Hz	22	uF	±20%	0.85	±0.20	±0.20	10.0%	Paper, 4Kpcs	(II)*
	C3216X5R226 FPSL	C3216X5R226 FP	0.5V, 120Hz	22	uF	±10%, ±20%	1.60	±0.30	±0.30	10.0%	Embossed, 2Kpcs	(II)
16V	C3216X5R225 EPS	C3216X5R225 EP	1V, 1kHz	2.2	uF	±10%, ±20%	1.60	±0.20	±0.30	5.0%	Embossed, 2Kpcs	(I)
	C3216X5R475 EPS	C3216X5R475 EP	1V, 1kHz	4.7	uF	±10%, ±20%	1.60	±0.20	±0.30	5.0%		(I)
	C3216X5R106 EPS	C3216X5R106 EP	1V, 1kHz	10	uF	±10%, ±20%	1.60	±0.20	±0.30	10.0%		(II)
	C3216X5R226 EPS	C3216X5R226 EP	0.5V, 120Hz	22	uF	±10%, ±20%	1.60	±0.20	±0.30	10.0%		(II)
	C3216X5R226METSE	C3216X5R226MET	0.5V, 120Hz	22	uF	±20%	0.85	±0.20	±0.20	10.0%	Paper, 4Kpcs	(II)*
	C3216X5R476MEPS	C3216X5R476MEP	0.5V, 120Hz	47	uF	±20%	1.60	±0.30	±0.30	10.0%	Embossed, 2Kpcs	(II)
10V	C3216X5R225 DPS	C3216X5R225 DP	1V, 1kHz	2.2	uF	±10%, ±20%	1.60	±0.20	±0.30	7.5%	Embossed, 2Kpcs	(I)
	C3216X5R475 DPS	C3216X5R475 DP	1V, 1kHz	4.7	uF	±10%, ±20%	1.60	±0.20	±0.30	7.5%		(I)
	C3216X5R106 DPS	C3216X5R106 DP	1V, 1kHz	10	uF	±10%, ±20%	1.60	±0.20	±0.30	10.0%		(II)
	C3216X5R226 DPS	C3216X5R226 DP	0.5V, 120Hz	22	uF	±10%, ±20%	1.60	±0.20	±0.30	10.0%		(II)
	C3216X5R226MDTSE	C3216X5R226MDT	0.5V, 120Hz	22	uF	±20%	0.85	±0.20	±0.20	10.0%	Paper, 4Kpcs	(II)*
	C3216X5R476 DPS	C3216X5R476 DP	0.5V, 120Hz	47	uF	±10%, ±20%	1.60	±0.20	±0.30	10.0%	Embossed, 2Kpcs	(II)
6.3V	C3216X5R226 CPS	C3216X5R226 CP	0.5V, 120Hz	22	uF	±10%, ±20%	1.60	±0.20	±0.30	15.0%	Embossed, 2Kpcs	(II)
	C3216X5R476MCPS	C3216X5R476MCP	0.5V, 120Hz	47	uF	±20%	1.60	±0.20	±0.20	10.0%		(II)
	C3216X5R107MCPS	C3216X5R107MCP	0.5V, 120Hz	100	uF	±20%	1.60	±0.30	±0.30	15.0%		(II)
4V	C3216X5R226 BPS	C3216X5R226 BP	0.5V, 120Hz	22	uF	±10%, ±20%	1.60	±0.20	±0.30	15.0%	Embossed, 2Kpcs	(II)
	C3216X5R476MBPS	C3216X5R476MBP	0.5V, 120Hz	47	uF	±20%	1.60	±0.20	±0.30	15.0%		(II)
	C3216X5R107MBPS	C3216X5R107MBP	0.5V, 120Hz	100	uF	±20%	1.60	±0.30	±0.30	15.0%		(II)
	C3216X5R227MBPSL	C3216X5R227MBP	0.5V, 120Hz	220	uF	±20%	1.60	±0.30	±0.30	15.0%		(II)

● C3225X5R Series (EIA1210)

RV	DARFON P/N	DARFON P/N 2	Measuring Condition	Capacitance		Available Tolerance	Thick. (mm)	Tolerance(mm)		DF (max.)	Standard Packing	Test Spec.
				Value	Unit			L/W	Thick.			
50V	C3225X5R106 GPS	C3225X5R106 GP	1V, 1kHz	10	uF	±10%, ±20%	2.50	±0.30/±0.20	±0.20	5.0%	Embossed, 1Kpcs	(II)
35V	C3225X5R106 NPS	C3225X5R106 NP	1V, 1kHz	10	uF	±10%, ±20%	2.50	±0.30/±0.20	±0.20	5.0%	Embossed, 1Kpcs	(I)
25V	C3225X5R475 FWS	C3225X5R475 FW	1V, 1kHz	4.7	uF	±10%, ±20%	2.00	±0.30/±0.20	±0.20	10.0%	Embossed, 1Kpcs	(I)
	C3225X5R106 FPS	C3225X5R106 FP	1V, 1kHz	10	uF	±10%, ±20%	2.00	±0.30/±0.20	±0.20	10.0%	Embossed, 2Kpcs	(I)
16V	C3225X5R226 FPS	C3225X5R226 FP	0.5V, 120Hz	22	uF	±10%, ±20%	2.50	±0.30/±0.20	±0.20	10.0%	Embossed, 1Kpcs	(II)
	C3225X5R475 EWS	C3225X5R475 EW	1V, 1kHz	4.7	uF	±10%, ±20%	2.00	±0.30/±0.20	±0.20	5.0%	Embossed, 1Kpcs	(I)
	C3225X5R106 EPS	C3225X5R106 EP	1V, 1kHz	10	uF	±10%, ±20%	2.00	±0.30/±0.20	±0.20	5.0%	Embossed, 2Kpcs	(I)
	C3225X5R226 EWS	C3225X5R226 EW	0.5V, 120Hz	22	uF	±10%, ±20%	2.50	±0.30/±0.20	±0.20	15.0%	Embossed, 0.5Kpcs	(II)
	C3225X5R476 EWS	C3225X5R476 EW	0.5V, 120Hz	47	uF	±10%, ±20%	2.50	±0.30/±0.20	±0.20	15.0%		(II)
	10V	C3225X5R476 EPS	C3225X5R476 EP	0.5V, 120Hz	47	uF	±10%, ±20%	2.50	±0.30/±0.20	±0.20	15.0%	Embossed, 1Kpcs
C3225X5R107MEPS		C3225X5R107MEP	0.5V, 120Hz	100	uF	±20%	2.50	±0.30	±0.30	10.0%	(II)	
C3225X5R226 DPS		C3225X5R226 DP	0.5V, 120Hz	22	uF	±10%, ±20%	2.50	±0.30/±0.20	±0.20	10.0%	(II)	
6.3V	C3225X5R476 DPS	C3225X5R476 DP	0.5V, 120Hz	47	uF	±10%, ±20%	2.50	±0.30/±0.20	±0.20	10.0%	Embossed, 1Kpcs	(II)
	C3225X5R107MDPS	C3225X5R107MDP	0.5V, 120Hz	100	uF	±20%	2.50	±0.30/±0.20	±0.30	10.0%		(II)
	C3225X5R226 CPS	C3225X5R226 CP	0.5V, 120Hz	22	uF	±10%, ±20%	2.50	±0.30/±0.20	±0.20	10.0%		(II)
	C3225X5R476 CPS	C3225X5R476 CP	0.5V, 120Hz	47	uF	±10%, ±20%	2.50	±0.30/±0.20	±0.20	15.0%	Embossed, 1Kpcs	(II)
	C3225X5R107MCPS	C3225X5R107MCP	0.5V, 120Hz	100	uF	±20%	2.50	±0.30	±0.30	15.0%		(II)

● C4532X5R Series (EIA1812)

RV	DARFON P/N	DARFON P/N 2	Measuring Condition	Capacitance		Available Tolerance	Thick. (mm)	Tolerance(mm)		DF (max.)	Standard Packing	Test Spec.
				Value	Unit			L/W	Thick.			
50V	C4532X5R225KGPS	C4532X5R225KGP	1V, 1kHz	2.2	uF	±10%	1.60	±0.30	±0.20	10.0%	Embossed, 1Kpcs	(II)*

□ Tolerance Code: K=±10%, M=±20% ;Special tolerance on the request.;

(II)* High temperature load life test are applicable in rated voltage *100%

- X6S Series
- C0603X6S Series (EIA0201)

RV	DARFON P/N	DARFON P/N 2	Measuring Condition	Capacitance		Available Tolerance	Thick. (mm)	Tolerance(mm)		DF (max.)	Standard Packing	Test Spec.
				Value	Unit			L/W	Thick.			
25V	C0603X6S104KFTS	C0603X6S104KFT	1V, 1kHz	100	nF	±10%	0.30	±0.03	±0.03	10.0%	Paper, 15Kpcs	(II)*
16V	C0603X6S104 ETS	C0603X6S104 ET	1V, 1kHz	100	nF	±10%, ±20%	0.30	±0.03	±0.03	10.0%	Paper, 15Kpcs	(II)
10V	C0603X6S104KDT	C0603X6S104KDT	1V, 1kHz	100	nF	±10%	0.30	±0.03	±0.03	10.0%	Paper, 15Kpcs	(II)
6.3V	C0603X6S103 CT	C0603X6S103 CT	1V, 1kHz	10	nF	±10%, ±20%	0.30	±0.03	±0.03	5.0%	Paper, 15Kpcs	(I)
	C0603X6S473 CT	C0603X6S473 CT	1V, 1kHz	47	nF	±10%, ±20%	0.30	±0.03	±0.03	10.0%		(I)
	C0603X6S104 CT	C0603X6S104 CT	1V, 1kHz	100	nF	±10%, ±20%	0.30	±0.03	±0.03	10.0%		(II)*
	C0603X6S224 CT	C0603X6S224 CT	0.5V, 1kHz	220	nF	±10%, ±20%	0.30	±0.03	±0.03	10.0%		(II)*
	C0603X6S105MCTS	C0603X6S105MCT	0.5V, 1kHz	1	uF	±20%	0.30	±0.09	±0.09	10.0%		(II)*
4V	C0603X6S104 BTS	C0603X6S104 BT	0.5V, 1kHz	100	nF	±10%, ±20%	0.30	±0.03	±0.03	10.0%	Paper, 15Kpcs	(II)
	C0603X6S224 BTS	C0603X6S224 BT	0.5V, 1kHz	220	nF	±10%, ±20%	0.30	±0.03	±0.03	10.0%		(II)
	C0603X6S105MBTS	C0603X6S105MBT	0.5V, 1kHz	1	uF	±20%	0.30	±0.20	±0.20	10.0%		(II)*

- C1005X6S Series (EIA0402)

RV	DARFON P/N	DARFON P/N 2	Measuring Condition	Capacitance		Available Tolerance	Thick. (mm)	Tolerance(mm)		DF (max.)	Standard Packing	Test Spec.
				Value	Unit			L/W	Thick.			
25V	C1005X6S104KFTS	C1005X6S104KFT	1V, 1kHz	100	nF	±10%	0.50	±0.05	±0.05	10.0%	Paper, 10Kpcs	(II)
	C1005X6S105 FTS	C1005X6S105 FT	0.5V, 1kHz	1.0	uF	±10%, ±20%	0.50	±0.10	±0.10	10.0%		(II)*
16V	C1005X6S105 ETS	C1005X6S105 ET	0.5V, 1kHz	1.0	uF	±10%, ±20%	0.50	±0.10	±0.10	12.5%	Paper, 10Kpcs	(II)*
	C1005X6S225METS	C1005X6S225MET	1V, 1kHz	2.2	uF	±20%	0.50	±0.20	±0.20	10.0%	Paper, 10Kpcs	(II)
10V	C1005X6S105 DTS	C1005X6S105 DT	0.5V, 1kHz	1.0	uF	±10%, ±20%	0.50	±0.05	±0.05	12.5%	Paper, 10Kpcs	(II)*
	C1005X6S225KDTS	C1005X6S225KDT	1V, 1kHz	2.2	uF	±10%	0.50	±0.20	±0.20	10.0%	Paper, 10Kpcs	(II)
6.3V	C1005X6S224KCTS	C1005X6S224KCT	1V, 1kHz	220	nF	±10%	0.50	±0.05	±0.05	10.0%	Paper, 10Kpcs	(II)
	C1005X6S105 CT	C1005X6S105 CT	0.5V, 1kHz	1.0	uF	±10%, ±20%	0.50	±0.05	±0.05	10.0%		(II)*
	C1005X6S225 CT	C1005X6S225 CT	0.5V, 1kHz	2.2	uF	±10%, ±20%	0.50	±0.05	±0.05	10.0%		(II)*
	C1005X6S475MCTS	C1005X6S475MCT	0.5V, 1kHz	4.7	uF	±20%	0.50	±0.15	±0.15	10.0%		(II)*
	C1005X6S106MCTS	C1005X6S106MCT	0.5V, 1kHz	10	uF	±20%	0.50	±0.20	±0.20	10.0%		(II)*
4V	C1005X6S106MBTS	C1005X6S106MBT	0.5V, 1kHz	10	uF	±20%	0.50	±0.20	±0.20	10.0%	Paper, 10Kpcs	(II)*

- C1608X6S Series (EIA0603)

RV	DARFON P/N	DARFON P/N 2	Measuring Condition	Capacitance		Available Tolerance	Thick. (mm)	Tolerance(mm)		DF (max.)	Standard Packing	Test Spec.
				Value	Unit			L/W	Thick.			
25V	C1608X6S475 FTS	C1608X6S475 FT	1V, 1kHz	4.7	uF	±10%, ±20%	0.80	±0.20	±0.20	10.0%	Paper, 4Kpcs	(II)*
16V	C1608X6S105KETS	C1608X6S105KET	1V, 1kHz	1.0	uF	±10%	0.80	±0.15	±0.15	10.0%	Paper, 4Kpcs	(II)
	C1608X6S225KETS	C1608X6S225KET	1V, 1kHz	2.2	uF	±10%	0.80	±0.10	±0.10	10.0%		(II)
	C1608X6S475KETS	C1608X6S475KET	1V, 1kHz	4.7	uF	±10%	0.80	±0.20	±0.20	10.0%		(II)
	C1608X6S106METS	C1608X6S106MET	1V, 1kHz	10	uF	±20%	0.80	±0.20	±0.20	10.0%		(II)
10V	C1608X6S225KDTS	C1608X6S225KDT	1V, 1kHz	2.2	uF	±10%	0.80	±0.10	±0.10	10.0%	Paper, 4Kpcs	(II)
	C1608X6S475KDTS	C1608X6S475KDT	1V, 1kHz	4.7	uF	±10%	0.80	±0.15	±0.15	10.0%		(II)
	C1608X6S106MDTS	C1608X6S106MDT	1V, 1kHz	10	uF	±20%	0.80	±0.20	±0.20	10.0%		(II)
6.3V	C1608X6S475 CT	C1608X6S475 CT	1V, 1kHz	4.7	uF	±10%, ±20%	0.80	±0.10	±0.10	10.0%	Paper, 4Kpcs	(II)*
	C1608X6S106MCTS	C1608X6S106MCT	0.5V, 120Hz	10	uF	±20%	0.80	±0.20	±0.20	10.0%		(II)
	C1608X6S226MCTS	C1608X6S226MCT	0.5V, 120Hz	22	uF	±20%	0.80	±0.20	±0.20	10.0%		(II)*

- C2012X6S Series (EIA0805)

RV	DARFON P/N	DARFON P/N 2	Measuring Condition	Capacitance		Available Tolerance	Thick. (mm)	Tolerance(mm)		DF (max.)	Standard Packing	Test Spec.
				Value	Unit			L/W	Thick.			
50V	C2012X6S475KGPS	C2012X6S475KGP	1V, 1kHz	4.7	uF	±10%	1.25	±0.20	±0.20	10.0%	Embossed, 3Kpcs	(II)
25V	C2012X6S106KFPS	C2012X6S106KEP	0.5V, 1kHz	10	uF	±10%	1.25	±0.15	±0.20	12.5%	Embossed, 3Kpcs	(II)*
16V	C2012X6S106KEPS	C2012X6S106KEP	1V, 1kHz	10	uF	±10%	1.25	±0.15	±0.15	10.0%	Embossed, 3Kpcs	(II)
	C2012X6S226MEPS	C2012X6S226MEP	0.5V, 120Hz	22	uF	±20%	1.25	±0.20	±0.20	10.0%		(II)*
10V	C2012X6S106KDPS	C2012X6S106KDP	0.5V, 1kHz	10	uF	±10%	1.25	±0.15	±0.15	10.0%	Embossed, 3Kpcs	(II)*
	C2012X6S226MDPS	C2012X6S226MDP	0.5V, 120Hz	22	uF	±20%	1.25	±0.20	±0.20	10.0%		(II)
6.3V	C2012X6S106MCPS	C2012X6S106MCP	0.5V, 1kHz	10	uF	±20%	1.25	±0.15	±0.15	10.0%	Embossed, 3Kpcs	(II)*
	C2012X6S226MCPS	C2012X6S226MCP	0.5V, 120Hz	22	uF	±20%	1.25	±0.15	±0.15	10.0%		(II)*
4V	C2012X6S106MBPS	C2012X6S106MBP	0.5V, 1kHz	10	uF	±20%	1.25	±0.15	±0.15	10.0%	Embossed, 3Kpcs	(II)
	C2012X6S226MBPS	C2012X6S226MBP	0.5V, 120Hz	22	uF	±20%	1.25	±0.15	±0.15	10.0%		(II)
	C2012X6S476MBPS	C2012X6S476MBP	0.5V, 120Hz	47	uF	±20%	1.25	±0.20	±0.20	10.0%		(II)*
	C2012X6S107MBPS	C2012X6S107MBP	0.5V, 120Hz	100	uF	±20%	1.25	±0.20	±0.20	10.0%		(II)*

● C3216X6S Series (EIA1206)

RV	DARFON P/N	DARFON P/N 2	Measuring Condition	Capacitance		Available Tolerance	Thick. (mm)	Tolerance(mm)		DF (max.)	Standard Packing	Test Spec.
				Value	Unit			L/W	Thick.			
35V	C3216X6S106KNPS	C3216X6S106KNP	1V , 1kHz	10	uF	±10%	1.60	±0.20	±0.20	10.0%	Embossed, 2Kpcs	(II)
	C3216X6S106KFPS	C3216X6S106KFP	1V , 1kHz	10	uF	±10%	1.60	±0.20	±0.20	10.0%	Embossed, 2Kpcs	(II)
25V	C3216X6S226□FPS	C3216X6S226□FP	0.5V , 120Hz	22	uF	±10%,±20%	1.60	±0.30	±0.30	10.0%		(II)
16V	C3216X6S226MEPS	C3216X6S226MEP	0.5V , 120Hz	22	uF	±20%	1.60	±0.20	±0.20	10.0%	Embossed, 2Kpcs	(II)
10V	C3216X6S476MDPS	C3216X6S476MDP	0.5V , 120Hz	47	uF	±20%	1.60	±0.30	±0.30	10.0%	Embossed, 2Kpcs	(II)
6.3V	C3216X6S476MCPS	C3216X6S476MCP	0.5V , 120Hz	47	uF	±20%	1.60	±0.20	±0.20	10.0%	Embossed, 2Kpcs	(II)
4V	C3216X6S226MBTS	C3216X6S226MBT	0.5V , 120Hz	22	uF	±20%	0.85	±0.20	±0.10	10.0%	Paper, 4Kpcs	(II)
	C3216X6S107MBPS	C3216X6S107MBP	0.5V , 120Hz	100	uF	±20%	1.60	±0.20	±0.20	10.0%	Embossed, 2Kpcs	(II)

● C3225X6S Series (EIA1210)

RV	DARFON P/N	DARFON P/N 2	Measuring Condition	Capacitance		Available Tolerance	Thick. (mm)	Tolerance(mm)		DF (max.)	Standard Packing	Test Spec.
				Value	Unit			L/W	Thick.			
16V	C3225X6S476MEPS	C3225X6S476MEP	0.5V , 120Hz	47	uF	±20%	2.50	±0.30	±0.20	10.0%	Embossed, 1Kpcs	(II)*
6.3V	C3225X6S107MCPS	C3225X6S107MCP	0.5V , 120Hz	100	uF	±20%	2.50	±0.30	±0.30	10.0%	Embossed, 1Kpcs	(II)

□ Tolerance Code: K=±10%, M=±20% ;Special tolerance on the request.;

(II)* High temperature load life test are applicable in rated voltage *100%

■ X7R Series
● C0603X7R Series(EIA0201)

RV	DARFON P/N	DARFON P/N 2	Measuring Condition	Capacitance		Available Tolerance	Thick. (mm)	Tolerance(mm)		DF (max.)	Standard Packing	Test Spec.
				Value	Unit			L/W	Thick.			
50V	C0603X7R101□GTS	C0603X7R101□GT	1V, 1kHz	100	pF	±10%, ±5%	0.30	±0.03	±0.03	3.0%	Paper, 15Kpcs	(I)
	C0603X7R121KGTS	C0603X7R121KGT	1V, 1kHz	120	pF	±10%	0.30	±0.03	±0.03	3.0%		(I)
	C0603X7R151KGTS	C0603X7R151KGT	1V, 1kHz	150	pF	±10%	0.30	±0.03	±0.03	3.0%		(I)
	C0603X7R181KGTS	C0603X7R181KGT	1V, 1kHz	180	pF	±10%	0.30	±0.03	±0.03	3.0%		(I)
	C0603X7R221□GTS	C0603X7R221□GT	1V, 1kHz	220	pF	±10%, ±5%	0.30	±0.03	±0.03	3.0%		(I)
	C0603X7R271KGTS	C0603X7R271KGT	1V, 1kHz	270	pF	±10%	0.30	±0.03	±0.03	3.0%		(I)
	C0603X7R331KGTS	C0603X7R331KGT	1V, 1kHz	330	pF	±10%	0.30	±0.03	±0.03	3.0%		(I)
	C0603X7R391KGTS	C0603X7R391KGT	1V, 1kHz	390	pF	±10%	0.30	±0.03	±0.03	3.0%		(I)
	C0603X7R471KGTS	C0603X7R471KGT	1V, 1kHz	470	pF	±10%	0.30	±0.03	±0.03	3.0%		(I)
	C0603X7R561KGTS	C0603X7R561KGT	1V, 1kHz	560	pF	±10%	0.30	±0.03	±0.03	3.0%		(I)
	C0603X7R681□GTS	C0603X7R681□GT	1V, 1kHz	680	pF	±10%, ±5%	0.30	±0.03	±0.03	3.0%		(I)
	C0603X7R821KGTS	C0603X7R821KGT	1V, 1kHz	820	pF	±10%	0.30	±0.03	±0.03	3.0%		(I)
	C0603X7R102KGTS	C0603X7R102KGT	1V, 1kHz	1.0	nF	±10%	0.30	±0.03	±0.03	3.0%		(I)
	C0603X7R122KGTS	C0603X7R122KGT	1V, 1kHz	1.2	nF	±10%	0.30	±0.03	±0.03	3.0%		(I)
	C0603X7R152KGTS	C0603X7R152KGT	1V, 1kHz	1.5	nF	±10%	0.30	±0.03	±0.03	3.0%		(I)
C0603X7R182KGTS	C0603X7R182KGT	1V, 1kHz	1.8	nF	±10%	0.30	±0.03	±0.03	3.0%	(I)		
C0603X7R222KGTS	C0603X7R222KGT	1V, 1kHz	2.2	nF	±10%	0.30	±0.03	±0.03	3.0%	(I)		
25V	C0603X7R101KFTS	C0603X7R101KFT	1V, 1kHz	100	pF	±10%	0.30	±0.03	±0.03	3.5%	Paper, 15Kpcs	(I)
	C0603X7R121KFTS	C0603X7R121KFT	1V, 1kHz	120	pF	±10%	0.30	±0.03	±0.03	3.5%		(I)
	C0603X7R151KFTS	C0603X7R151KFT	1V, 1kHz	150	pF	±10%	0.30	±0.03	±0.03	3.5%		(I)
	C0603X7R181KFTS	C0603X7R181KFT	1V, 1kHz	180	pF	±10%	0.30	±0.03	±0.03	3.5%		(I)
	C0603X7R221KFTS	C0603X7R221KFT	1V, 1kHz	220	pF	±10%	0.30	±0.03	±0.03	3.5%		(I)
	C0603X7R271KFTS	C0603X7R271KFT	1V, 1kHz	270	pF	±10%	0.30	±0.03	±0.03	3.5%		(I)
	C0603X7R331KFTS	C0603X7R331KFT	1V, 1kHz	330	pF	±10%	0.30	±0.03	±0.03	3.5%		(I)
	C0603X7R391KFTS	C0603X7R391KFT	1V, 1kHz	390	pF	±10%	0.30	±0.03	±0.03	3.5%		(I)
	C0603X7R471KFTS	C0603X7R471KFT	1V, 1kHz	470	pF	±10%	0.30	±0.03	±0.03	3.5%		(I)
	C0603X7R561KFTS	C0603X7R561KFT	1V, 1kHz	560	pF	±10%	0.30	±0.03	±0.03	3.5%		(I)
	C0603X7R681KFTS	C0603X7R681KFT	1V, 1kHz	680	pF	±10%	0.30	±0.03	±0.03	3.5%		(I)
	C0603X7R821KFTS	C0603X7R821KFT	1V, 1kHz	820	pF	±10%	0.30	±0.03	±0.03	3.5%		(I)
	C0603X7R102KFTS	C0603X7R102KFT	1V, 1kHz	1.0	nF	±10%	0.30	±0.03	±0.03	3.5%		(I)
	C0603X7R122KFTS	C0603X7R122KFT	1V, 1kHz	1.2	nF	±10%	0.30	±0.03	±0.03	3.5%		(I)
	C0603X7R152KFTS	C0603X7R152KFT	1V, 1kHz	1.5	nF	±10%	0.30	±0.03	±0.03	3.5%		(I)
C0603X7R182KFTS	C0603X7R182KFT	1V, 1kHz	1.8	nF	±10%	0.30	±0.03	±0.03	3.5%	(I)		
C0603X7R222KFTS	C0603X7R222KFT	1V, 1kHz	2.2	nF	±10%	0.30	±0.03	±0.03	3.5%	(I)		
C0603X7R332KFTS	C0603X7R332KFT	1V, 1kHz	3.3	nF	±10%	0.30	±0.03	±0.03	5.0%	(I)		
16V	C0603X7R221KETS	C0603X7R221KET	1V, 1kHz	220	pF	±10%	0.30	±0.03	±0.03	3.5%	Paper, 15Kpcs	(I)
	C0603X7R331KETS	C0603X7R331KET	1V, 1kHz	330	pF	±10%	0.30	±0.03	±0.03	3.5%		(I)
	C0603X7R471KETS	C0603X7R471KET	1V, 1kHz	470	pF	±10%	0.30	±0.03	±0.03	3.5%		(I)
	C0603X7R681□ETS	C0603X7R681□ET	1V, 1kHz	680	pF	±10%, ±5%	0.30	±0.03	±0.03	3.5%		(I)
	C0603X7R821□ETS	C0603X7R821□ET	1V, 1kHz	820	pF	±10%, ±5%	0.30	±0.03	±0.03	3.5%		(I)
	C0603X7R102□ETS	C0603X7R102□ET	1V, 1kHz	1.0	nF	±10%, ±5%	0.30	±0.03	±0.03	3.5%		(I)
	C0603X7R152□ETS	C0603X7R152□ET	1V, 1kHz	1.5	nF	±10%, ±5%	0.30	±0.03	±0.03	3.5%		(I)
	C0603X7R222KETS	C0603X7R222KET	1V, 1kHz	2.2	nF	±10%	0.30	±0.03	±0.03	3.5%		(I)
	C0603X7R272□ETS	C0603X7R272□ET	1V, 1kHz	2.7	nF	±10%, ±5%	0.30	±0.03	±0.03	5.0%		(I)
	C0603X7R332KETS	C0603X7R332KET	1V, 1kHz	3.3	nF	±10%	0.30	±0.03	±0.03	5.0%		(I)
	C0603X7R392KETS	C0603X7R392KET	1V, 1kHz	3.9	nF	±10%	0.30	±0.03	±0.03	5.0%		(I)
	C0603X7R472KETS	C0603X7R472KET	1V, 1kHz	4.7	nF	±10%	0.30	±0.03	±0.03	5.0%		(I)
	C0603X7R562KETS	C0603X7R562KET	1V, 1kHz	5.6	nF	±10%	0.30	±0.03	±0.03	5.0%		(I)
	C0603X7R682KETS	C0603X7R682KET	1V, 1kHz	6.8	nF	±10%	0.30	±0.03	±0.03	5.0%		(I)
	C0603X7R822KETS	C0603X7R822KET	1V, 1kHz	8.2	nF	±10%	0.30	±0.03	±0.03	5.0%		(I)
C0603X7R103KETS	C0603X7R103KET	1V, 1kHz	10	nF	±10%	0.30	±0.03	±0.03	5.0%	(I)		
10V	C0603X7R182KDTS	C0603X7R182KDT	1V, 1kHz	1.8	nF	±10%	0.30	±0.03	±0.03	5.0%	Paper, 15Kpcs	(I)
	C0603X7R272□DTS	C0603X7R272□DT	1V, 1kHz	2.7	nF	±10%, ±5%	0.30	±0.03	±0.03	5.0%		(I)
	C0603X7R332KDTS	C0603X7R332KDT	1V, 1kHz	3.3	nF	±10%	0.30	±0.03	±0.03	5.0%		(I)
	C0603X7R392KDTS	C0603X7R392KDT	1V, 1kHz	3.9	nF	±10%	0.30	±0.03	±0.03	5.0%		(I)
	C0603X7R472KDTS	C0603X7R472KDT	1V, 1kHz	4.7	nF	±10%	0.30	±0.03	±0.03	5.0%		(I)
	C0603X7R562KDTS	C0603X7R562KDT	1V, 1kHz	5.6	nF	±10%	0.30	±0.03	±0.03	5.0%		(I)
	C0603X7R682KDTS	C0603X7R682KDT	1V, 1kHz	6.8	nF	±10%	0.30	±0.03	±0.03	5.0%		(I)
	C0603X7R822KDTS	C0603X7R822KDT	1V, 1kHz	8.2	nF	±10%	0.30	±0.03	±0.03	5.0%		(I)
C0603X7R103KDTS	C0603X7R103KDT	1V, 1kHz	10	nF	±10%	0.30	±0.03	±0.03	5.0%	(I)		

□ Tolerance Code: J=±5%, K=±10%, M=±20%; Special tolerance on the request.

● C1005X7R Series (EIA0402)

RV	DARFON P/N	DARFON P/N 2	Measuring Condition	Capacitance		Available Tolerance	Thick. (mm)	Tolerance(mm)		DF (max.)	Standard Packing	Test Spec.
				Value	Unit			L/W	Thick.			
50V	C1005X7R101□GTS	C1005X7R101□GT	1V, 1kHz	100	pF	±10%, ±5%	0.50	±0.05	±0.05	3.0%	Paper, 10Kpcs	(I)
	C1005X7R121KGTS	C1005X7R121KGT	1V, 1kHz	120	pF	±10%	0.50	±0.05	±0.05	3.0%		(I)
	C1005X7R151KGTS	C1005X7R151KGT	1V, 1kHz	150	pF	±10%	0.50	±0.05	±0.05	3.0%		(I)
	C1005X7R181KGTS	C1005X7R181KGT	1V, 1kHz	180	pF	±10%	0.50	±0.05	±0.05	3.0%		(I)
	C1005X7R221KGTS	C1005X7R221KGT	1V, 1kHz	220	pF	±10%	0.50	±0.05	±0.05	3.0%		(I)
	C1005X7R271KGTS	C1005X7R271KGT	1V, 1kHz	270	pF	±10%	0.50	±0.05	±0.05	3.0%		(I)
	C1005X7R331KGTS	C1005X7R331KGT	1V, 1kHz	330	pF	±10%	0.50	±0.05	±0.05	3.0%		(I)
	C1005X7R391KGTS	C1005X7R391KGT	1V, 1kHz	390	pF	±10%	0.50	±0.05	±0.05	3.0%		(I)
	C1005X7R471KGTS	C1005X7R471KGT	1V, 1kHz	470	pF	±10%	0.50	±0.05	±0.05	3.0%		(I)
	C1005X7R561KGTS	C1005X7R561KGT	1V, 1kHz	560	pF	±10%	0.50	±0.05	±0.05	3.0%		(I)
	C1005X7R681KGTS	C1005X7R681KGT	1V, 1kHz	680	pF	±10%	0.50	±0.05	±0.05	3.0%		(I)
	C1005X7R821KGTS	C1005X7R821KGT	1V, 1kHz	820	pF	±10%	0.50	±0.05	±0.05	3.0%		(I)
	C1005X7R102□GTS	C1005X7R102□GT	1V, 1kHz	1.0	nF	±10%, ±5%	0.50	±0.05	±0.05	3.0%		(I)
	C1005X7R122KGTS	C1005X7R122KGT	1V, 1kHz	1.2	nF	±10%	0.50	±0.05	±0.05	3.0%		(I)
	C1005X7R152KGTS	C1005X7R152KGT	1V, 1kHz	1.5	nF	±10%	0.50	±0.05	±0.05	3.0%		(I)
	C1005X7R182KGTS	C1005X7R182KGT	1V, 1kHz	1.8	nF	±10%	0.50	±0.05	±0.05	3.0%		(I)
	C1005X7R222□GTS	C1005X7R222□GT	1V, 1kHz	2.2	nF	±10%, ±5%	0.50	±0.05	±0.05	3.0%		(I)
	C1005X7R272□GTS	C1005X7R272□GT	1V, 1kHz	2.7	nF	±10%, ±5%	0.50	±0.05	±0.05	3.0%		(I)
	C1005X7R332□GTS	C1005X7R332□GT	1V, 1kHz	3.3	nF	±10%, ±5%	0.50	±0.05	±0.05	3.0%		(I)
	C1005X7R392KGTS	C1005X7R392KGT	1V, 1kHz	3.9	nF	±10%	0.50	±0.05	±0.05	3.0%		(I)
	C1005X7R472KGTS	C1005X7R472KGT	1V, 1kHz	4.7	nF	±10%	0.50	±0.05	±0.05	3.0%		(I)
	C1005X7R562KGTS	C1005X7R562KGT	1V, 1kHz	5.6	nF	±10%	0.50	±0.05	±0.05	3.0%		(I)
	C1005X7R682KGTS	C1005X7R682KGT	1V, 1kHz	6.8	nF	±10%	0.50	±0.05	±0.05	3.0%		(I)
	C1005X7R822KGTS	C1005X7R822KGT	1V, 1kHz	8.2	nF	±10%	0.50	±0.05	±0.05	3.0%		(I)
C1005X7R103KGTS	C1005X7R103KGT	1V, 1kHz	10	nF	±10%	0.50	±0.05	±0.05	3.0%	(I)		
C1005X7R123KGTS	C1005X7R123KGT	1V, 1kHz	12	nF	±10%	0.50	±0.05	±0.05	3.0%	(I)		
C1005X7R153KGTS	C1005X7R153KGT	1V, 1kHz	15	nF	±10%	0.50	±0.05	±0.05	3.0%	(I)		
C1005X7R223KGTS	C1005X7R223KGT	1V, 1kHz	22	nF	±10%	0.50	±0.05	±0.05	3.0%	(I)		
C1005X7R333KGTS	C1005X7R333KGT	1V, 1kHz	33	nF	±10%	0.50	±0.05	±0.05	3.5%	(I)		
C1005X7R473KGTS	C1005X7R473KGT	1V, 1kHz	47	nF	±10%	0.50	±0.05	±0.05	10.0%	(II)		
C1005X7R104KGTS	C1005X7R104KGT	1V, 1kHz	100	nF	±10%	0.50	±0.05	±0.05	10.0%	(II)		
25V	C1005X7R101KFSTS	C1005X7R101KFST	1V, 1kHz	100	pF	±10%	0.50	±0.05	±0.05	3.0%	Paper, 10Kpcs	(I)
	C1005X7R121KFSTS	C1005X7R121KFST	1V, 1kHz	120	pF	±10%	0.50	±0.05	±0.05	3.0%		(I)
	C1005X7R151KFSTS	C1005X7R151KFST	1V, 1kHz	150	pF	±10%	0.50	±0.05	±0.05	3.0%		(I)
	C1005X7R181KFSTS	C1005X7R181KFST	1V, 1kHz	180	pF	±10%	0.50	±0.05	±0.05	3.0%		(I)
	C1005X7R221KFSTS	C1005X7R221KFST	1V, 1kHz	220	pF	±10%	0.50	±0.05	±0.05	3.0%		(I)
	C1005X7R271KFSTS	C1005X7R271KFST	1V, 1kHz	270	pF	±10%	0.50	±0.05	±0.05	3.0%		(I)
	C1005X7R331KFSTS	C1005X7R331KFST	1V, 1kHz	330	pF	±10%	0.50	±0.05	±0.05	3.0%		(I)
	C1005X7R391KFSTS	C1005X7R391KFST	1V, 1kHz	390	pF	±10%	0.50	±0.05	±0.05	3.0%		(I)
	C1005X7R471KFSTS	C1005X7R471KFST	1V, 1kHz	470	pF	±10%	0.50	±0.05	±0.05	3.0%		(I)
	C1005X7R561KFSTS	C1005X7R561KFST	1V, 1kHz	560	pF	±10%	0.50	±0.05	±0.05	3.0%		(I)
	C1005X7R681KFSTS	C1005X7R681KFST	1V, 1kHz	680	pF	±10%	0.50	±0.05	±0.05	3.0%		(I)
	C1005X7R821KFSTS	C1005X7R821KFST	1V, 1kHz	820	pF	±10%	0.50	±0.05	±0.05	3.0%		(I)
	C1005X7R102KFSTS	C1005X7R102KFST	1V, 1kHz	1.0	nF	±10%	0.50	±0.05	±0.05	3.0%		(I)
	C1005X7R122KFSTS	C1005X7R122KFST	1V, 1kHz	1.2	nF	±10%	0.50	±0.05	±0.05	3.0%		(I)
	C1005X7R152KFSTS	C1005X7R152KFST	1V, 1kHz	1.5	nF	±10%	0.50	±0.05	±0.05	3.0%		(I)
	C1005X7R182KFSTS	C1005X7R182KFST	1V, 1kHz	1.8	nF	±10%	0.50	±0.05	±0.05	3.0%		(I)
	C1005X7R222KFSTS	C1005X7R222KFST	1V, 1kHz	2.2	nF	±10%	0.50	±0.05	±0.05	3.0%		(I)
	C1005X7R272KFSTS	C1005X7R272KFST	1V, 1kHz	2.7	nF	±10%	0.50	±0.05	±0.05	3.0%		(I)
	C1005X7R332□FTS	C1005X7R332□FT	1V, 1kHz	3.3	nF	±10%, ±5%	0.50	±0.05	±0.05	3.0%		(I)
	C1005X7R392KFSTS	C1005X7R392KFST	1V, 1kHz	3.9	nF	±10%	0.50	±0.05	±0.05	3.0%		(I)
	C1005X7R472KFSTS	C1005X7R472KFST	1V, 1kHz	4.7	nF	±10%	0.50	±0.05	±0.05	3.0%		(I)
	C1005X7R562KFSTS	C1005X7R562KFST	1V, 1kHz	5.6	nF	±10%	0.50	±0.05	±0.05	3.0%		(I)
	C1005X7R682KFSTS	C1005X7R682KFST	1V, 1kHz	6.8	nF	±10%	0.50	±0.05	±0.05	3.0%		(I)
	C1005X7R822KFSTS	C1005X7R822KFST	1V, 1kHz	8.2	nF	±10%	0.50	±0.05	±0.05	3.0%		(I)
	C1005X7R103□FTS	C1005X7R103□FT	1V, 1kHz	10	nF	±10%, ±5%	0.50	±0.05	±0.05	3.0%		(I)
	C1005X7R123KFSTS	C1005X7R123KFST	1V, 1kHz	12	nF	±10%	0.50	±0.05	±0.05	3.0%		(I)
	C1005X7R153□FTS	C1005X7R153□FT	1V, 1kHz	15	nF	±10%, ±5%	0.50	±0.05	±0.05	3.0%		(I)
	C1005X7R183KFSTS	C1005X7R183KFST	1V, 1kHz	18	nF	±10%	0.50	±0.05	±0.05	3.0%		(I)
	C1005X7R223KFSTS	C1005X7R223KFST	1V, 1kHz	22	nF	±10%	0.50	±0.05	±0.05	3.0%		(I)
	C1005X7R273KFSTS	C1005X7R273KFST	1V, 1kHz	27	nF	±10%	0.50	±0.05	±0.05	3.5%		(I)
	C1005X7R333KFSTS	C1005X7R333KFST	1V, 1kHz	33	nF	±10%	0.50	±0.05	±0.05	3.5%		(I)
	C1005X7R473KFSTS	C1005X7R473KFST	1V, 1kHz	47	nF	±10%	0.50	±0.05	±0.05	3.5%		(I)
C1005X7R563KFSTS	C1005X7R563KFST	1V, 1kHz	56	nF	±10%	0.50	±0.05	±0.05	3.5%	(I)		
C1005X7R683KFSTS	C1005X7R683KFST	1V, 1kHz	68	nF	±10%	0.50	±0.05	±0.05	3.5%	(I)		
C1005X7R104KFSTS	C1005X7R104KFST	1V, 1kHz	100	nF	±10%	0.50	±0.05	±0.05	10.0%	(II)		
C1005X7R224KFSTS	C1005X7R224KFST	1V, 1kHz	220	nF	±10%	0.50	±0.05	±0.05	10.0%	(II)		
16V	C1005X7R101KETS	C1005X7R101KET	1V, 1kHz	100	pF	±10%	0.50	±0.05	±0.05	5.0%	Paper, 10Kpcs	(I)
	C1005X7R121KETS	C1005X7R121KET	1V, 1kHz	120	pF	±10%	0.50	±0.05	±0.05	5.0%		(I)
	C1005X7R151KETS	C1005X7R151KET	1V, 1kHz	150	pF	±10%	0.50	±0.05	±0.05	5.0%		(I)
	C1005X7R181KETS	C1005X7R181KET	1V, 1kHz	180	pF	±10%	0.50	±0.05	±0.05	5.0%		(I)
	C1005X7R221KETS	C1005X7R221KET	1V, 1kHz	220	pF	±10%	0.50	±0.05	±0.05	5.0%		(I)

RV	DARFON P/N	DARFON P/N 2	Measuring Condition	Capacitance		Available Tolerance	Thick. (mm)	Tolerance(mm)		DF (max.)	Standard Packing	Test Spec.
				Value	Unit			L/W	Thick.			
16V	C1005X7R271KETS	C1005X7R271KET	1V, 1kHz	270	pF	±10%	0.50	±0.05	±0.05	5.0%	Paper, 10Kpcs	(I)
	C1005X7R331KETS	C1005X7R331KET	1V, 1kHz	330	pF	±10%	0.50	±0.05	±0.05	5.0%		(I)
	C1005X7R391KETS	C1005X7R391KET	1V, 1kHz	390	pF	±10%	0.50	±0.05	±0.05	5.0%		(I)
	C1005X7R471KETS	C1005X7R471KET	1V, 1kHz	470	pF	±10%	0.50	±0.05	±0.05	5.0%		(I)
	C1005X7R561KETS	C1005X7R561KET	1V, 1kHz	560	pF	±10%	0.50	±0.05	±0.05	5.0%		(I)
	C1005X7R681KETS	C1005X7R681KET	1V, 1kHz	680	pF	±10%	0.50	±0.05	±0.05	5.0%		(I)
	C1005X7R821KETS	C1005X7R821KET	1V, 1kHz	820	pF	±10%	0.50	±0.05	±0.05	5.0%		(I)
	C1005X7R102KETS	C1005X7R102KET	1V, 1kHz	1.0	nF	±10%	0.50	±0.05	±0.05	5.0%		(I)
	C1005X7R122KETS	C1005X7R122KET	1V, 1kHz	1.2	nF	±10%	0.50	±0.05	±0.05	5.0%		(I)
	C1005X7R152KETS	C1005X7R152KET	1V, 1kHz	1.5	nF	±10%	0.50	±0.05	±0.05	5.0%		(I)
	C1005X7R182KETS	C1005X7R182KET	1V, 1kHz	1.8	nF	±10%	0.50	±0.05	±0.05	5.0%		(I)
	C1005X7R222KETS	C1005X7R222KET	1V, 1kHz	2.2	nF	±10%	0.50	±0.05	±0.05	5.0%		(I)
	C1005X7R272KETS	C1005X7R272KET	1V, 1kHz	2.7	nF	±10%	0.50	±0.05	±0.05	5.0%		(I)
	C1005X7R332KETS	C1005X7R332KET	1V, 1kHz	3.3	nF	±10%	0.50	±0.05	±0.05	5.0%		(I)
	C1005X7R392KETS	C1005X7R392KET	1V, 1kHz	3.9	nF	±10%	0.50	±0.05	±0.05	5.0%		(I)
	C1005X7R472KETS	C1005X7R472KET	1V, 1kHz	4.7	nF	±10%	0.50	±0.05	±0.05	5.0%		(I)
	C1005X7R562KETS	C1005X7R562KET	1V, 1kHz	5.6	nF	±10%	0.50	±0.05	±0.05	5.0%		(I)
	C1005X7R682KETS	C1005X7R682KET	1V, 1kHz	6.8	nF	±10%	0.50	±0.05	±0.05	5.0%		(I)
	C1005X7R822KETS	C1005X7R822KET	1V, 1kHz	8.2	nF	±10%	0.50	±0.05	±0.05	5.0%		(I)
	C1005X7R103KETS	C1005X7R103KET	1V, 1kHz	10	nF	±10%	0.50	±0.05	±0.05	5.0%		(I)
	C1005X7R123KETS	C1005X7R123KET	1V, 1kHz	12	nF	±10%	0.50	±0.05	±0.05	5.0%		(I)
	C1005X7R153KETS	C1005X7R153KET	1V, 1kHz	15	nF	±10%	0.50	±0.05	±0.05	5.0%		(I)
	C1005X7R183KETS	C1005X7R183KET	1V, 1kHz	18	nF	±10%	0.50	±0.05	±0.05	5.0%		(I)
	C1005X7R223KETS	C1005X7R223KET	1V, 1kHz	22	nF	±10%	0.50	±0.05	±0.05	5.0%		(I)
	C1005X7R273KETS	C1005X7R273KET	1V, 1kHz	27	nF	±10%	0.50	±0.05	±0.05	5.0%		(I)
	C1005X7R333KETS	C1005X7R333KET	1V, 1kHz	33	nF	±10%	0.50	±0.05	±0.05	5.0%		(I)
	C1005X7R393KETS	C1005X7R393KET	1V, 1kHz	39	nF	±10%	0.50	±0.05	±0.05	5.0%		(I)
	C1005X7R473KETS	C1005X7R473KET	1V, 1kHz	47	nF	±10%	0.50	±0.05	±0.05	5.0%		(I)
	C1005X7R563KETS	C1005X7R563KET	1V, 1kHz	56	nF	±10%	0.50	±0.05	±0.05	5.0%		(I)
	C1005X7R683KETS	C1005X7R683KET	1V, 1kHz	68	nF	±10%	0.50	±0.05	±0.05	5.0%		(I)
	C1005X7R823KETS	C1005X7R823KET	1V, 1kHz	82	nF	±10%	0.50	±0.05	±0.05	5.0%		(I)
	C1005X7R104□ETS	C1005X7R104□ET	1V, 1kHz	100	nF	±10%, ±20%	0.50	±0.05	±0.05	5.0%		(I)
C1005X7R154KETS	C1005X7R154KET	1V, 1kHz	150	nF	±10%	0.50	±0.05	±0.05	10.0%	(II)		
C1005X7R224KETS	C1005X7R224KET	1V, 1kHz	220	nF	±10%	0.50	±0.05	±0.05	10.0%	(II)		
10V	C1005X7R101KDTS	C1005X7R101KDT	1V, 1kHz	100	pF	±10%	0.50	±0.05	±0.05	5.0%	Paper, 10Kpcs	(I)
	C1005X7R121KDTS	C1005X7R121KDT	1V, 1kHz	120	pF	±10%	0.50	±0.05	±0.05	5.0%		(I)
	C1005X7R151KDTS	C1005X7R151KDT	1V, 1kHz	150	pF	±10%	0.50	±0.05	±0.05	5.0%		(I)
	C1005X7R181KDTS	C1005X7R181KDT	1V, 1kHz	180	pF	±10%	0.50	±0.05	±0.05	5.0%		(I)
	C1005X7R221KDTS	C1005X7R221KDT	1V, 1kHz	220	pF	±10%	0.50	±0.05	±0.05	5.0%		(I)
	C1005X7R271KDTS	C1005X7R271KDT	1V, 1kHz	270	pF	±10%	0.50	±0.05	±0.05	5.0%		(I)
	C1005X7R331KDTS	C1005X7R331KDT	1V, 1kHz	330	pF	±10%	0.50	±0.05	±0.05	5.0%		(I)
	C1005X7R391KDTS	C1005X7R391KDT	1V, 1kHz	390	pF	±10%	0.50	±0.05	±0.05	5.0%		(I)
	C1005X7R471KDTS	C1005X7R471KDT	1V, 1kHz	470	pF	±10%	0.50	±0.05	±0.05	5.0%		(I)
	C1005X7R561KDTS	C1005X7R561KDT	1V, 1kHz	560	pF	±10%	0.50	±0.05	±0.05	5.0%		(I)
	C1005X7R681KDTS	C1005X7R681KDT	1V, 1kHz	680	pF	±10%	0.50	±0.05	±0.05	5.0%		(I)
	C1005X7R821KDTS	C1005X7R821KDT	1V, 1kHz	820	pF	±10%	0.50	±0.05	±0.05	5.0%		(I)
	C1005X7R102KDTS	C1005X7R102KDT	1V, 1kHz	1.0	nF	±10%	0.50	±0.05	±0.05	5.0%		(I)
	C1005X7R122KDTS	C1005X7R122KDT	1V, 1kHz	1.2	nF	±10%	0.50	±0.05	±0.05	5.0%		(I)
	C1005X7R152KDTS	C1005X7R152KDT	1V, 1kHz	1.5	nF	±10%	0.50	±0.05	±0.05	5.0%		(I)
	C1005X7R182KDTS	C1005X7R182KDT	1V, 1kHz	1.8	nF	±10%	0.50	±0.05	±0.05	5.0%		(I)
	C1005X7R222KDTS	C1005X7R222KDT	1V, 1kHz	2.2	nF	±10%	0.50	±0.05	±0.05	5.0%		(I)
	C1005X7R272KDTS	C1005X7R272KDT	1V, 1kHz	2.7	nF	±10%	0.50	±0.05	±0.05	5.0%		(I)
	C1005X7R332KDTS	C1005X7R332KDT	1V, 1kHz	3.3	nF	±10%	0.50	±0.05	±0.05	5.0%		(I)
	C1005X7R392KDTS	C1005X7R392KDT	1V, 1kHz	3.9	nF	±10%	0.50	±0.05	±0.05	5.0%		(I)
	C1005X7R472KDTS	C1005X7R472KDT	1V, 1kHz	4.7	nF	±10%	0.50	±0.05	±0.05	5.0%		(I)
	C1005X7R562KDTS	C1005X7R562KDT	1V, 1kHz	5.6	nF	±10%	0.50	±0.05	±0.05	5.0%		(I)
	C1005X7R682KDTS	C1005X7R682KDT	1V, 1kHz	6.8	nF	±10%	0.50	±0.05	±0.05	5.0%		(I)
	C1005X7R822KDTS	C1005X7R822KDT	1V, 1kHz	8.2	nF	±10%	0.50	±0.05	±0.05	5.0%		(I)
	C1005X7R103KDTS	C1005X7R103KDT	1V, 1kHz	10	nF	±10%	0.50	±0.05	±0.05	5.0%		(I)
	C1005X7R123KDTS	C1005X7R123KDT	1V, 1kHz	12	nF	±10%	0.50	±0.05	±0.05	5.0%		(I)
	C1005X7R153KDTS	C1005X7R153KDT	1V, 1kHz	15	nF	±10%	0.50	±0.05	±0.05	5.0%		(I)
	C1005X7R183KDTS	C1005X7R183KDT	1V, 1kHz	18	nF	±10%	0.50	±0.05	±0.05	5.0%		(I)
	C1005X7R223KDTS	C1005X7R223KDT	1V, 1kHz	22	nF	±10%	0.50	±0.05	±0.05	5.0%		(I)
	C1005X7R273KDTS	C1005X7R273KDT	1V, 1kHz	27	nF	±10%	0.50	±0.05	±0.05	5.0%		(I)
	C1005X7R333KDTS	C1005X7R333KDT	1V, 1kHz	33	nF	±10%	0.50	±0.05	±0.05	5.0%		(I)
	C1005X7R393KDTS	C1005X7R393KDT	1V, 1kHz	39	nF	±10%	0.50	±0.05	±0.05	5.0%		(I)
C1005X7R473KDTS	C1005X7R473KDT	1V, 1kHz	47	nF	±10%	0.50	±0.05	±0.05	5.0%	(I)		
C1005X7R563KDTS	C1005X7R563KDT	1V, 1kHz	56	nF	±10%	0.50	±0.05	±0.05	5.0%	(I)		
C1005X7R683KDTS	C1005X7R683KDT	1V, 1kHz	68	nF	±10%	0.50	±0.05	±0.05	5.0%	(I)		
C1005X7R823KDTS	C1005X7R823KDT	1V, 1kHz	82	nF	±10%	0.50	±0.05	±0.05	5.0%	(I)		
C1005X7R104KDTS	C1005X7R104KDT	1V, 1kHz	100	nF	±10%	0.50	±0.05	±0.05	5.0%	(I)		
C1005X7R224KDTS	C1005X7R224KDT	1V, 1kHz	220	nF	±10%	0.50	±0.05	±0.05	10.0%	(II)		
C1005X7R474KDTS	C1005X7R474KDT	1V, 1kHz	470	nF	±10%	0.50	±0.05	±0.05	10.0%	(II)		
6.3V	C1005X7R473KCTS	C1005X7R473KCT	1V, 1kHz	47	nF	±10%	0.50	±0.05	±0.05	5.0%	Paper, 10Kpcs	(I)
	C1005X7R474□CTS	C1005X7R474□CT	1V, 1kHz	470	nF	±10%, ±20%	0.50	±0.05	±0.05	10.0%		(II)
	C1005X7R105□CTS	C1005X7R105□CT	1V, 1kHz	1.0	uF	±10%, ±20%	0.50	±0.05	±0.05	12.5%		(II)*

□ Tolerance Code: J=±5%, K=±10%, M=±20%.

● C1608X7R Series (EIA0603)

RV	DARFON P/N	DARFON P/N 2	Measuring Condition	Capacitance		Available Tolerance	Thick. (mm)	Tolerance(mm)		DF (max.)	Standard Packing	Test Spec.
				Value	Unit			L/W	Thick.			
50V	C1608X7R101KGTS	C1608X7R101KGT	1V, 1kHz	100	pF	±10%	0.80	±0.10	±0.10	2.5%	Paper, 4Kpcs	(I)
	C1608X7R121KGTS	C1608X7R121KGT	1V, 1kHz	120	pF	±10%	0.80	±0.10	±0.10	2.5%		(I)
	C1608X7R151KGTS	C1608X7R151KGT	1V, 1kHz	150	pF	±10%	0.80	±0.10	±0.10	2.5%		(I)
	C1608X7R181KGTS	C1608X7R181KGT	1V, 1kHz	180	pF	±10%	0.80	±0.10	±0.10	2.5%		(I)
	C1608X7R221KGTS	C1608X7R221KGT	1V, 1kHz	220	pF	±10%	0.80	±0.10	±0.10	2.5%		(I)
	C1608X7R271KGTS	C1608X7R271KGT	1V, 1kHz	270	pF	±10%	0.80	±0.10	±0.10	2.5%		(I)
	C1608X7R331KGTS	C1608X7R331KGT	1V, 1kHz	330	pF	±10%	0.80	±0.10	±0.10	2.5%		(I)
	C1608X7R391KGTS	C1608X7R391KGT	1V, 1kHz	390	pF	±10%	0.80	±0.10	±0.10	2.5%		(I)
	C1608X7R471KGTS	C1608X7R471KGT	1V, 1kHz	470	pF	±10%	0.80	±0.10	±0.10	2.5%		(I)
	C1608X7R561KGTS	C1608X7R561KGT	1V, 1kHz	560	pF	±10%	0.80	±0.10	±0.10	2.5%		(I)
	C1608X7R681KGTS	C1608X7R681KGT	1V, 1kHz	680	pF	±10%	0.80	±0.10	±0.10	2.5%		(I)
	C1608X7R821KGTS	C1608X7R821KGT	1V, 1kHz	820	pF	±10%	0.80	±0.10	±0.10	2.5%		(I)
	C1608X7R102KGTS	C1608X7R102KGT	1V, 1kHz	1.0	nF	±10%	0.80	±0.10	±0.10	2.5%		(I)
	C1608X7R122KGTS	C1608X7R122KGT	1V, 1kHz	1.2	nF	±10%	0.80	±0.10	±0.10	2.5%		(I)
	C1608X7R152KGTS	C1608X7R152KGT	1V, 1kHz	1.5	nF	±10%	0.80	±0.10	±0.10	2.5%		(I)
	C1608X7R182KGTS	C1608X7R182KGT	1V, 1kHz	1.8	nF	±10%	0.80	±0.10	±0.10	2.5%		(I)
	C1608X7R202KGTS	C1608X7R202KGT	1V, 1kHz	2.0	nF	±10%	0.80	±0.10	±0.10	2.5%		(I)
	C1608X7R222KGTS	C1608X7R222KGT	1V, 1kHz	2.2	nF	±10%	0.80	±0.10	±0.10	2.5%		(I)
	C1608X7R272KGTS	C1608X7R272KGT	1V, 1kHz	2.7	nF	±10%	0.80	±0.10	±0.10	2.5%		(I)
	C1608X7R332KGTS	C1608X7R332KGT	1V, 1kHz	3.3	nF	±10%	0.80	±0.10	±0.10	2.5%		(I)
	C1608X7R392KGTS	C1608X7R392KGT	1V, 1kHz	3.9	nF	±10%	0.80	±0.10	±0.10	2.5%		(I)
	C1608X7R472KGTS	C1608X7R472KGT	1V, 1kHz	4.7	nF	±10%	0.80	±0.10	±0.10	2.5%		(I)
	C1608X7R562KGTS	C1608X7R562KGT	1V, 1kHz	5.6	nF	±10%	0.80	±0.10	±0.10	2.5%		(I)
	C1608X7R682KGTS	C1608X7R682KGT	1V, 1kHz	6.8	nF	±10%	0.80	±0.10	±0.10	2.5%		(I)
	C1608X7R822KGTS	C1608X7R822KGT	1V, 1kHz	8.2	nF	±10%	0.80	±0.10	±0.10	2.5%		(I)
	C1608X7R103□GTS	C1608X7R103□GT	1V, 1kHz	10	nF	±10%, ±5%	0.80	±0.10	±0.10	2.5%		(I)
	C1608X7R123KGTS	C1608X7R123KGT	1V, 1kHz	12	nF	±10%	0.80	±0.10	±0.10	2.5%		(I)
	C1608X7R153KGTS	C1608X7R153KGT	1V, 1kHz	15	nF	±10%	0.80	±0.10	±0.10	2.5%		(I)
	C1608X7R183KGTS	C1608X7R183KGT	1V, 1kHz	18	nF	±10%	0.80	±0.10	±0.10	2.5%		(I)
	C1608X7R223KGTS	C1608X7R223KGT	1V, 1kHz	22	nF	±10%	0.80	±0.10	±0.10	2.5%		(I)
	C1608X7R273KGTS	C1608X7R273KGT	1V, 1kHz	27	nF	±10%	0.80	±0.10	±0.10	2.5%		(I)
	C1608X7R333KGTS	C1608X7R333KGT	1V, 1kHz	33	nF	±10%	0.80	±0.15	±0.15	2.5%		(I)
	C1608X7R393KGTS	C1608X7R393KGT	1V, 1kHz	39	nF	±10%	0.80	±0.15	±0.15	2.5%		(I)
C1608X7R473KGTS	C1608X7R473KGT	1V, 1kHz	47	nF	±10%	0.80	±0.15	±0.15	3.0%	(I)		
C1608X7R563KGTS	C1608X7R563KGT	1V, 1kHz	56	nF	±10%	0.80	±0.15	±0.15	3.0%	(I)		
C1608X7R683KGTS	C1608X7R683KGT	1V, 1kHz	68	nF	±10%	0.80	±0.15	±0.15	3.0%	(I)		
C1608X7R823KGTS	C1608X7R823KGT	1V, 1kHz	82	nF	±10%	0.80	±0.15	±0.15	3.0%	(I)		
C1608X7R104KGTS	C1608X7R104KGT	1V, 1kHz	100	nF	±10%	0.80	±0.15	±0.15	3.5%	(II)		
C1608X7R224KGTS	C1608X7R224KGT	1V, 1kHz	220	nF	±10%	0.80	±0.15	±0.15	3.5%	(II)		
C1608X7R474KGTS	C1608X7R474KGT	1V, 1kHz	470	nF	±10%	0.80	±0.15	±0.15	10.0%	(III)		
C1608X7R105KGTS	C1608X7R105KGT	1V, 1kHz	1.0	uF	±10%	0.80	±0.20	±0.20	10.0%	(II)		
35V	C1608X7R474KNTS	C1608X7R474KNT	1V, 1kHz	470	nF	±10%	0.80	±0.15	±0.15	10.0%	Paper, 4Kpcs	(II)
25V	C1608X7R101KFSTS	C1608X7R101KFT	1V, 1kHz	100	pF	±10%	0.80	±0.10	±0.10	3.5%	Paper, 4Kpcs	(I)
	C1608X7R121KFSTS	C1608X7R121KFT	1V, 1kHz	120	pF	±10%	0.80	±0.10	±0.10	3.5%		(I)
	C1608X7R151KFSTS	C1608X7R151KFT	1V, 1kHz	150	pF	±10%	0.80	±0.10	±0.10	3.5%		(I)
	C1608X7R181KFSTS	C1608X7R181KFT	1V, 1kHz	180	pF	±10%	0.80	±0.10	±0.10	3.5%		(I)
	C1608X7R221KFSTS	C1608X7R221KFT	1V, 1kHz	220	pF	±10%	0.80	±0.10	±0.10	3.5%		(I)
	C1608X7R271KFSTS	C1608X7R271KFT	1V, 1kHz	270	pF	±10%	0.80	±0.10	±0.10	3.5%		(I)
	C1608X7R331KFSTS	C1608X7R331KFT	1V, 1kHz	330	pF	±10%	0.80	±0.10	±0.10	3.5%		(I)
	C1608X7R391KFSTS	C1608X7R391KFT	1V, 1kHz	390	pF	±10%	0.80	±0.10	±0.10	3.5%		(I)
	C1608X7R471KFSTS	C1608X7R471KFT	1V, 1kHz	470	pF	±10%	0.80	±0.10	±0.10	3.5%		(I)
	C1608X7R561KFSTS	C1608X7R561KFT	1V, 1kHz	560	pF	±10%	0.80	±0.10	±0.10	3.5%		(I)
	C1608X7R681KFSTS	C1608X7R681KFT	1V, 1kHz	680	pF	±10%	0.80	±0.10	±0.10	3.5%		(I)
	C1608X7R821KFSTS	C1608X7R821KFT	1V, 1kHz	820	pF	±10%	0.80	±0.10	±0.10	3.5%		(I)
	C1608X7R102KFSTS	C1608X7R102KFT	1V, 1kHz	1.0	nF	±10%	0.80	±0.10	±0.10	3.5%		(I)
	C1608X7R122KFSTS	C1608X7R122KFT	1V, 1kHz	1.2	nF	±10%	0.80	±0.10	±0.10	3.5%		(I)
	C1608X7R152KFSTS	C1608X7R152KFT	1V, 1kHz	1.5	nF	±10%	0.80	±0.10	±0.10	3.5%		(I)
	C1608X7R182KFSTS	C1608X7R182KFT	1V, 1kHz	1.8	nF	±10%	0.80	±0.10	±0.10	3.5%		(I)
	C1608X7R222KFSTS	C1608X7R222KFT	1V, 1kHz	2.2	nF	±10%	0.80	±0.10	±0.10	3.5%		(I)
	C1608X7R272KFSTS	C1608X7R272KFT	1V, 1kHz	2.7	nF	±10%	0.80	±0.10	±0.10	3.5%		(I)
	C1608X7R332KFSTS	C1608X7R332KFT	1V, 1kHz	3.3	nF	±10%	0.80	±0.10	±0.10	3.5%		(I)
	C1608X7R392KFSTS	C1608X7R392KFT	1V, 1kHz	3.9	nF	±10%	0.80	±0.10	±0.10	3.5%		(I)
	C1608X7R472KFSTS	C1608X7R472KFT	1V, 1kHz	4.7	nF	±10%	0.80	±0.10	±0.10	3.5%		(I)
	C1608X7R562KFSTS	C1608X7R562KFT	1V, 1kHz	5.6	nF	±10%	0.80	±0.10	±0.10	3.5%		(I)
	C1608X7R682KFSTS	C1608X7R682KFT	1V, 1kHz	6.8	nF	±10%	0.80	±0.10	±0.10	3.5%		(I)
	C1608X7R822KFSTS	C1608X7R822KFT	1V, 1kHz	8.2	nF	±10%	0.80	±0.10	±0.10	3.5%		(I)
C1608X7R103KFSTS	C1608X7R103KFT	1V, 1kHz	10	nF	±10%	0.80	±0.10	±0.10	3.5%	(I)		

□ Tolerance Code: J=±5%, K=±10%, M=±20%; Special tolerance on the request.

RV	DARFON P/N	DARFON P/N 2	Measuring Condition	Capacitance		Available Tolerance	Thick. (mm)	Tolerance(mm)		DF (max.)	Standard Packing	Test Spec.
				Value	Unit			L/W	Thick.			
25V	C1608X7R123KFST	C1608X7R123KFT	1V, 1kHz	12	nF	±10%	0.80	±0.10	±0.10	3.5%	Paper, 4Kpcs	(I)
	C1608X7R153KFST	C1608X7R153KFT	1V, 1kHz	15	nF	±10%	0.80	±0.10	±0.10	3.5%		(I)
	C1608X7R183KFST	C1608X7R183KFT	1V, 1kHz	18	nF	±10%	0.80	±0.10	±0.10	3.5%		(I)
	C1608X7R223KFST	C1608X7R223KFT	1V, 1kHz	22	nF	±10%	0.80	±0.10	±0.10	3.5%		(I)
	C1608X7R273KFST	C1608X7R273KFT	1V, 1kHz	27	nF	±10%, ±5%	0.80	±0.10	±0.10	3.5%		(I)
	C1608X7R333KFST	C1608X7R333KFT	1V, 1kHz	33	nF	±10%	0.80	±0.10	±0.10	3.5%		(I)
	C1608X7R393KFST	C1608X7R393KFT	1V, 1kHz	39	nF	±10%	0.80	±0.10	±0.10	3.5%		(I)
	C1608X7R473KFST	C1608X7R473KFT	1V, 1kHz	47	nF	±10%	0.80	±0.10	±0.10	3.5%		(I)
	C1608X7R563KFST	C1608X7R563KFT	1V, 1kHz	56	nF	±10%	0.80	±0.10	±0.10	3.5%		(I)
	C1608X7R683KFST	C1608X7R683KFT	1V, 1kHz	68	nF	±10%	0.80	±0.10	±0.10	3.5%		(I)
	C1608X7R823KFST	C1608X7R823KFT	1V, 1kHz	82	nF	±10%	0.80	±0.10	±0.10	3.5%		(I)
	C1608X7R104KFST	C1608X7R104KFT	1V, 1kHz	100	nF	±10%	0.80	±0.10	±0.10	3.5%		(I)
	C1608X7R124KFST	C1608X7R124KFT	1V, 1kHz	120	nF	±10%	0.80	±0.15	±0.15	3.5%		(I)
	C1608X7R154KFST	C1608X7R154KFT	1V, 1kHz	150	nF	±10%	0.80	±0.15	±0.15	3.5%		(I)
	C1608X7R224KFST	C1608X7R224KFT	1V, 1kHz	220	nF	±10%	0.80	±0.15	±0.15	3.5%		(I)
	C1608X7R334KFST	C1608X7R334KFT	1V, 1kHz	330	nF	±10%	0.80	±0.15	±0.15	7.0%		(I)
C1608X7R474KFST	C1608X7R474KFT	1V, 1kHz	470	nF	±10%	0.80	±0.15	±0.15	10.0%	(I)		
C1608X7R105KFST	C1608X7R105KFT	1V, 1kHz	1.0	uF	±10%	0.80	±0.15	±0.15	10.0%	(II)		
16V	C1608X7R101KETS	C1608X7R101KET	1V, 1kHz	100	pF	±10%	0.80	±0.10	±0.10	5.0%	Paper, 4Kpcs	(I)
	C1608X7R121KETS	C1608X7R121KET	1V, 1kHz	120	pF	±10%	0.80	±0.10	±0.10	5.0%		(I)
	C1608X7R151KETS	C1608X7R151KET	1V, 1kHz	150	pF	±10%	0.80	±0.10	±0.10	5.0%		(I)
	C1608X7R181KETS	C1608X7R181KET	1V, 1kHz	180	pF	±10%	0.80	±0.10	±0.10	5.0%		(I)
	C1608X7R221KETS	C1608X7R221KET	1V, 1kHz	220	pF	±10%	0.80	±0.10	±0.10	5.0%		(I)
	C1608X7R271KETS	C1608X7R271KET	1V, 1kHz	270	pF	±10%	0.80	±0.10	±0.10	5.0%		(I)
	C1608X7R331KETS	C1608X7R331KET	1V, 1kHz	330	pF	±10%	0.80	±0.10	±0.10	5.0%		(I)
	C1608X7R391KETS	C1608X7R391KET	1V, 1kHz	390	pF	±10%	0.80	±0.10	±0.10	5.0%		(I)
	C1608X7R471KETS	C1608X7R471KET	1V, 1kHz	470	pF	±10%	0.80	±0.10	±0.10	5.0%		(I)
	C1608X7R561KETS	C1608X7R561KET	1V, 1kHz	560	pF	±10%	0.80	±0.10	±0.10	5.0%		(I)
	C1608X7R681KETS	C1608X7R681KET	1V, 1kHz	680	pF	±10%	0.80	±0.10	±0.10	5.0%		(I)
	C1608X7R821KETS	C1608X7R821KET	1V, 1kHz	820	pF	±10%	0.80	±0.10	±0.10	5.0%		(I)
	C1608X7R102KETS	C1608X7R102KET	1V, 1kHz	1.0	nF	±10%	0.80	±0.10	±0.10	5.0%		(I)
	C1608X7R122KETS	C1608X7R122KET	1V, 1kHz	1.2	nF	±10%	0.80	±0.10	±0.10	5.0%		(I)
	C1608X7R152KETS	C1608X7R152KET	1V, 1kHz	1.5	nF	±10%	0.80	±0.10	±0.10	5.0%		(I)
	C1608X7R182KETS	C1608X7R182KET	1V, 1kHz	1.8	nF	±10%	0.80	±0.10	±0.10	5.0%		(I)
	C1608X7R222KETS	C1608X7R222KET	1V, 1kHz	2.2	nF	±10%	0.80	±0.10	±0.10	5.0%		(I)
	C1608X7R272KETS	C1608X7R272KET	1V, 1kHz	2.7	nF	±10%	0.80	±0.10	±0.10	5.0%		(I)
	C1608X7R332KETS	C1608X7R332KET	1V, 1kHz	3.3	nF	±10%	0.80	±0.10	±0.10	5.0%		(I)
	C1608X7R392KETS	C1608X7R392KET	1V, 1kHz	3.9	nF	±10%	0.80	±0.10	±0.10	5.0%		(I)
	C1608X7R472KETS	C1608X7R472KET	1V, 1kHz	4.7	nF	±10%	0.80	±0.10	±0.10	5.0%		(I)
	C1608X7R562KETS	C1608X7R562KET	1V, 1kHz	5.6	nF	±10%	0.80	±0.10	±0.10	5.0%		(I)
	C1608X7R682KETS	C1608X7R682KET	1V, 1kHz	6.8	nF	±10%	0.80	±0.10	±0.10	5.0%		(I)
	C1608X7R822KETS	C1608X7R822KET	1V, 1kHz	8.2	nF	±10%	0.80	±0.10	±0.10	5.0%		(I)
	C1608X7R103KETS	C1608X7R103KET	1V, 1kHz	10	nF	±10%	0.80	±0.10	±0.10	5.0%		(I)
	C1608X7R123KETS	C1608X7R123KET	1V, 1kHz	12	nF	±10%	0.80	±0.10	±0.10	5.0%		(I)
	C1608X7R153KETS	C1608X7R153KET	1V, 1kHz	15	nF	±10%	0.80	±0.10	±0.10	5.0%		(I)
	C1608X7R183KETS	C1608X7R183KET	1V, 1kHz	18	nF	±10%	0.80	±0.10	±0.10	5.0%		(I)
	C1608X7R223KETS	C1608X7R223KET	1V, 1kHz	22	nF	±10%	0.80	±0.10	±0.10	5.0%		(I)
	C1608X7R273KETS	C1608X7R273KET	1V, 1kHz	27	nF	±10%	0.80	±0.10	±0.10	5.0%		(I)
	C1608X7R333KETS	C1608X7R333KET	1V, 1kHz	33	nF	±10%	0.80	±0.10	±0.10	5.0%		(I)
	C1608X7R393KETS	C1608X7R393KET	1V, 1kHz	39	nF	±10%	0.80	±0.10	±0.10	5.0%		(I)
	C1608X7R473KETS	C1608X7R473KET	1V, 1kHz	47	nF	±10%	0.80	±0.10	±0.10	5.0%		(I)
	C1608X7R563KETS	C1608X7R563KET	1V, 1kHz	56	nF	±10%	0.80	±0.10	±0.10	5.0%		(I)
	C1608X7R683KETS	C1608X7R683KET	1V, 1kHz	68	nF	±10%	0.80	±0.10	±0.10	5.0%		(I)
	C1608X7R823KETS	C1608X7R823KET	1V, 1kHz	82	nF	±10%	0.80	±0.10	±0.10	5.0%		(I)
C1608X7R104KETS	C1608X7R104KET	1V, 1kHz	100	nF	±10%	0.80	±0.10	±0.10	5.0%	(I)		
C1608X7R154KETS	C1608X7R154KET	1V, 1kHz	150	nF	±10%	0.80	±0.10	±0.10	5.0%	(I)		
C1608X7R224KETS	C1608X7R224KET	1V, 1kHz	220	nF	±10%	0.80	±0.15	±0.15	5.0%	(I)		
C1608X7R334KETS	C1608X7R334KET	1V, 1kHz	330	nF	±10%	0.80	±0.15	±0.15	5.0%	(I)		
C1608X7R474KETS	C1608X7R474KET	1V, 1kHz	470	nF	±10%	0.80	±0.15	±0.15	5.0%	(I)		
C1608X7R684KETS	C1608X7R684KET	1V, 1kHz	680	nF	±10%	0.80	±0.15	±0.15	10.0%	(I)		
C1608X7R105KETS	C1608X7R105KET	1V, 1kHz	1.0	uF	±10%	0.80	±0.15	±0.15	10.0%	(II)		
C1608X7R225KETS	C1608X7R225KET	1V, 1kHz	2.2	uF	±10%	0.80	±0.20	±0.20	10.0%	(II)		

RV	DARFON P/N	DARFON P/N 2	Measuring Condition	Capacitance		Available Tolerance	Thick. (mm)	Tolerance(mm)		DF (max.)	Standard Packing	Test Spec.
				Value	Unit			L/W	Thick.			
10V	C1608X7R101KDTS	C1608X7R101KDT	1V, 1kHz	100	pF	±10%	0.80	±0.10	±0.10	5.0%	Paper, 4Kpcs	(I)
	C1608X7R121KDTS	C1608X7R121KDT	1V, 1kHz	120	pF	±10%	0.80	±0.10	±0.10	5.0%		(I)
	C1608X7R151KDTS	C1608X7R151KDT	1V, 1kHz	150	pF	±10%	0.80	±0.10	±0.10	5.0%		(I)
	C1608X7R181KDTS	C1608X7R181KDT	1V, 1kHz	180	pF	±10%	0.80	±0.10	±0.10	5.0%		(I)
	C1608X7R221KDTS	C1608X7R221KDT	1V, 1kHz	220	pF	±10%	0.80	±0.10	±0.10	5.0%		(I)
	C1608X7R271KDTS	C1608X7R271KDT	1V, 1kHz	270	pF	±10%	0.80	±0.10	±0.10	5.0%		(I)
	C1608X7R331KDTS	C1608X7R331KDT	1V, 1kHz	330	pF	±10%	0.80	±0.10	±0.10	5.0%		(I)
	C1608X7R391KDTS	C1608X7R391KDT	1V, 1kHz	390	pF	±10%	0.80	±0.10	±0.10	5.0%		(I)
	C1608X7R471KDTS	C1608X7R471KDT	1V, 1kHz	470	pF	±10%	0.80	±0.10	±0.10	5.0%		(I)
	C1608X7R561KDTS	C1608X7R561KDT	1V, 1kHz	560	pF	±10%	0.80	±0.10	±0.10	5.0%		(I)
	C1608X7R681KDTS	C1608X7R681KDT	1V, 1kHz	680	pF	±10%	0.80	±0.10	±0.10	5.0%		(I)
	C1608X7R821KDTS	C1608X7R821KDT	1V, 1kHz	820	pF	±10%	0.80	±0.10	±0.10	5.0%		(I)
	C1608X7R102KDTS	C1608X7R102KDT	1V, 1kHz	1.0	nF	±10%	0.80	±0.10	±0.10	5.0%		(I)
	C1608X7R122KDTS	C1608X7R122KDT	1V, 1kHz	1.2	nF	±10%	0.80	±0.10	±0.10	5.0%		(I)
	C1608X7R152KDTS	C1608X7R152KDT	1V, 1kHz	1.5	nF	±10%	0.80	±0.10	±0.10	5.0%		(I)
	C1608X7R182KDTS	C1608X7R182KDT	1V, 1kHz	1.8	nF	±10%	0.80	±0.10	±0.10	5.0%		(I)
	C1608X7R222KDTS	C1608X7R222KDT	1V, 1kHz	2.2	nF	±10%	0.80	±0.10	±0.10	5.0%		(I)
	C1608X7R272KDTS	C1608X7R272KDT	1V, 1kHz	2.7	nF	±10%	0.80	±0.10	±0.10	5.0%		(I)
	C1608X7R332KDTS	C1608X7R332KDT	1V, 1kHz	3.3	nF	±10%	0.80	±0.10	±0.10	5.0%		(I)
	C1608X7R392KDTS	C1608X7R392KDT	1V, 1kHz	3.9	nF	±10%	0.80	±0.10	±0.10	5.0%		(I)
	C1608X7R472KDTS	C1608X7R472KDT	1V, 1kHz	4.7	nF	±10%	0.80	±0.10	±0.10	5.0%		(I)
	C1608X7R562KDTS	C1608X7R562KDT	1V, 1kHz	5.6	nF	±10%	0.80	±0.10	±0.10	5.0%		(I)
	C1608X7R682KDTS	C1608X7R682KDT	1V, 1kHz	6.8	nF	±10%	0.80	±0.10	±0.10	5.0%		(I)
	C1608X7R822KDTS	C1608X7R822KDT	1V, 1kHz	8.2	nF	±10%	0.80	±0.10	±0.10	5.0%		(I)
	C1608X7R103KDTS	C1608X7R103KDT	1V, 1kHz	10	nF	±10%	0.80	±0.10	±0.10	5.0%		(I)
	C1608X7R123KDTS	C1608X7R123KDT	1V, 1kHz	12	nF	±10%	0.80	±0.10	±0.10	5.0%		(I)
	C1608X7R153KDTS	C1608X7R153KDT	1V, 1kHz	15	nF	±10%	0.80	±0.10	±0.10	5.0%		(I)
	C1608X7R183KDTS	C1608X7R183KDT	1V, 1kHz	18	nF	±10%	0.80	±0.10	±0.10	5.0%		(I)
	C1608X7R223KDTS	C1608X7R223KDT	1V, 1kHz	22	nF	±10%	0.80	±0.10	±0.10	5.0%		(I)
	C1608X7R273KDTS	C1608X7R273KDT	1V, 1kHz	27	nF	±10%	0.80	±0.10	±0.10	5.0%		(I)
	C1608X7R333KDTS	C1608X7R333KDT	1V, 1kHz	33	nF	±10%	0.80	±0.10	±0.10	5.0%		(I)
	C1608X7R393KDTS	C1608X7R393KDT	1V, 1kHz	39	nF	±10%	0.80	±0.10	±0.10	5.0%		(I)
	C1608X7R473KDTS	C1608X7R473KDT	1V, 1kHz	47	nF	±10%	0.80	±0.10	±0.10	5.0%		(I)
C1608X7R563KDTS	C1608X7R563KDT	1V, 1kHz	56	nF	±10%	0.80	±0.10	±0.10	5.0%	(I)		
C1608X7R683KDTS	C1608X7R683KDT	1V, 1kHz	68	nF	±10%	0.80	±0.10	±0.10	5.0%	(I)		
C1608X7R823KDTS	C1608X7R823KDT	1V, 1kHz	82	nF	±10%	0.80	±0.10	±0.10	5.0%	(I)		
C1608X7R104KDTS	C1608X7R104KDT	1V, 1kHz	100	nF	±10%	0.80	±0.10	±0.10	5.0%	(I)		
C1608X7R224KDTS	C1608X7R224KDT	1V, 1kHz	220	nF	±10%	0.80	±0.15	±0.15	5.0%	(I)		
C1608X7R334KDTS	C1608X7R334KDT	1V, 1kHz	330	nF	±10%	0.80	±0.15	±0.15	10.0%	(I)		
C1608X7R474KDTS	C1608X7R474KDT	1V, 1kHz	470	nF	±10%	0.80	±0.15	±0.15	10.0%	(I)		
C1608X7R684KDTS	C1608X7R684KDT	1V, 1kHz	680	nF	±10%	0.80	±0.15	±0.15	10.0%	(I)		
C1608X7R105KDTS	C1608X7R105KDT	1V, 1kHz	1.0	uF	±10%	0.80	±0.15	±0.15	10.0%	(II)		
C1608X7R225KDTS	C1608X7R225KDT	1V, 1kHz	2.2	uF	±10%	0.80	±0.15	±0.10	10.0%	(II)		
6.3V	C1608X7R104KCTS	C1608X7R104KCT	1V, 1kHz	100	nF	±10%	0.80	±0.10	±0.10	5.0%	Paper, 4Kpcs	(I)
	C1608X7R105KCTS	C1608X7R105KCT	1V, 1kHz	1.0	uF	±10%	0.80	±0.15	±0.15	10.0%		(II)
	C1608X7R225KCTS	C1608X7R225KCT	1V, 1kHz	2.2	uF	±10%	0.80	±0.15	±0.10	10.0%		(II)
	C1608X7R475KCTS	C1608X7R475KCT	1V, 1kHz	4.7	uF	±10%	0.80	±0.20	±0.20	10.0%		(II)

□ Tolerance Code: J=±5%, K=±10%, M=±20%; Special tolerance on the request.

● C2012X7R Series (EIA0805)

RV	DARFON P/N	DARFON P/N 2	Measuring Condition	Capacitance		Available Tolerance	Thick. (mm)	Tolerance(mm)		DF (max.)	Standard Packing	Test Spec.	
				Value	Unit			L/W	Thick.				
50V	C2012X7R151KGTSC		1V, 1kHz	150	pF	±10%	0.60	±0.15	±0.15	2.5%	Paper, 4Kpcs	(I)	
	C2012X7R151KGT	C2012X7R151KGT	1V, 1kHz	150	pF	±10%	0.85	±0.15	±0.15	2.5%		(I)	
	C2012X7R181KGTSC		1V, 1kHz	180	pF	±10%	0.60	±0.15	±0.15	2.5%		(I)	
	C2012X7R181KGT	C2012X7R181KGT	1V, 1kHz	180	pF	±10%	0.85	±0.15	±0.15	2.5%		(I)	
	C2012X7R221KGTSC		1V, 1kHz	220	pF	±10%	0.60	±0.15	±0.15	2.5%		(I)	
	C2012X7R221KGT	C2012X7R221KGT	1V, 1kHz	220	pF	±10%	0.85	±0.15	±0.15	2.5%		(I)	
	C2012X7R271KGTSC		1V, 1kHz	270	pF	±10%	0.60	±0.15	±0.15	2.5%		(I)	
	C2012X7R271KGT	C2012X7R271KGT	1V, 1kHz	270	pF	±10%	0.85	±0.15	±0.15	2.5%		(I)	
	C2012X7R331KGTSC		1V, 1kHz	330	pF	±10%	0.60	±0.15	±0.15	2.5%		(I)	
	C2012X7R331KGT	C2012X7R331KGT	1V, 1kHz	330	pF	±10%	0.85	±0.15	±0.15	2.5%		(I)	
	C2012X7R391KGTSC		1V, 1kHz	390	pF	±10%	0.60	±0.15	±0.15	2.5%		(I)	
	C2012X7R391KGT	C2012X7R391KGT	1V, 1kHz	390	pF	±10%	0.85	±0.15	±0.15	2.5%		(I)	
	C2012X7R471KGTSC		1V, 1kHz	470	pF	±10%	0.60	±0.15	±0.15	2.5%		(I)	
	C2012X7R471KGT	C2012X7R471KGT	1V, 1kHz	470	pF	±10%	0.85	±0.15	±0.15	2.5%		(I)	
	C2012X7R561KGTSC		1V, 1kHz	560	pF	±10%	0.60	±0.15	±0.15	2.5%		(I)	
	C2012X7R561KGT	C2012X7R561KGT	1V, 1kHz	560	pF	±10%	0.85	±0.15	±0.15	2.5%		(I)	
	C2012X7R681KGTSC		1V, 1kHz	680	pF	±10%	0.60	±0.15	±0.15	2.5%		(I)	
	C2012X7R681KGT	C2012X7R681KGT	1V, 1kHz	680	pF	±10%	0.85	±0.15	±0.15	2.5%		(I)	
	C2012X7R821KGTSC		1V, 1kHz	820	pF	±10%	0.60	±0.15	±0.15	2.5%		(I)	
	C2012X7R821KGT	C2012X7R821KGT	1V, 1kHz	820	pF	±10%	0.85	±0.15	±0.15	2.5%		(I)	
	C2012X7R102KGTSC		1V, 1kHz	1.0	nF	±10%	0.60	±0.15	±0.15	2.5%		(I)	
	C2012X7R102KGT	C2012X7R102KGT	1V, 1kHz	1.0	nF	±10%	0.85	±0.15	±0.15	2.5%		(I)	
	C2012X7R122KGTSC		1V, 1kHz	1.2	nF	±10%	0.60	±0.15	±0.15	2.5%		(I)	
	C2012X7R122KGT	C2012X7R122KGT	1V, 1kHz	1.2	nF	±10%	0.85	±0.15	±0.15	2.5%		(I)	
	C2012X7R152KGTSC		1V, 1kHz	1.5	nF	±10%	0.60	±0.15	±0.15	2.5%		(I)	
	C2012X7R152KGT	C2012X7R152KGT	1V, 1kHz	1.5	nF	±10%	0.85	±0.15	±0.15	2.5%		(I)	
	C2012X7R182KGTSC		1V, 1kHz	1.8	nF	±10%	0.60	±0.15	±0.15	2.5%		(I)	
	C2012X7R182KGT	C2012X7R182KGT	1V, 1kHz	1.8	nF	±10%	0.85	±0.15	±0.15	2.5%		(I)	
	C2012X7R222KGTSC		1V, 1kHz	2.2	nF	±10%	0.60	±0.15	±0.15	2.5%		(I)	
	C2012X7R222KGT	C2012X7R222KGT	1V, 1kHz	2.2	nF	±10%	0.85	±0.15	±0.15	2.5%		(I)	
	C2012X7R272KGTSC		1V, 1kHz	2.7	nF	±10%	0.60	±0.15	±0.15	2.5%		(I)	
	C2012X7R272KGT	C2012X7R272KGT	1V, 1kHz	2.7	nF	±10%	0.85	±0.15	±0.15	2.5%		(I)	
	C2012X7R332KGTSC		1V, 1kHz	3.3	nF	±10%	0.60	±0.15	±0.15	2.5%		(I)	
	C2012X7R332KGT	C2012X7R332KGT	1V, 1kHz	3.3	nF	±10%	0.85	±0.15	±0.15	2.5%		(I)	
	C2012X7R392KGTSC		1V, 1kHz	3.9	nF	±10%	0.60	±0.15	±0.15	2.5%		(I)	
	C2012X7R392KGT	C2012X7R392KGT	1V, 1kHz	3.9	nF	±10%	0.85	±0.15	±0.15	2.5%		(I)	
	C2012X7R472KGTSC		1V, 1kHz	4.7	nF	±10%	0.60	±0.15	±0.15	2.5%		(I)	
	C2012X7R472KGT	C2012X7R472KGT	1V, 1kHz	4.7	nF	±10%	0.85	±0.15	±0.15	2.5%		(I)	
	C2012X7R562KGTSC		1V, 1kHz	5.6	nF	±10%	0.60	±0.15	±0.15	2.5%		(I)	
	C2012X7R562KGT	C2012X7R562KGT	1V, 1kHz	5.6	nF	±10%	0.85	±0.15	±0.15	2.5%		(I)	
	C2012X7R682KGTSC		1V, 1kHz	6.8	nF	±10%	0.60	±0.15	±0.15	2.5%		(I)	
	C2012X7R682KGT	C2012X7R682KGT	1V, 1kHz	6.8	nF	±10%	0.80	±0.15	±0.15	2.5%		(I)	
	C2012X7R682KGP		1V, 1kHz	6.8	nF	±10%	1.25	±0.15	±0.20	2.5%		Embossed, 3Kpcs	(I)
	C2012X7R822KGTSC		1V, 1kHz	8.2	nF	±10%	0.60	±0.15	±0.15	2.5%			(I)
	C2012X7R822KGT	C2012X7R822KGT	1V, 1kHz	8.2	nF	±10%	0.85	±0.15	±0.15	2.5%			(I)
	C2012X7R103KGTSC		1V, 1kHz	10	nF	±10%	0.60	±0.15	±0.15	2.5%			(I)
	C2012X7R103KGT	C2012X7R103KGT	1V, 1kHz	10	nF	±10%	0.85	±0.15	±0.15	2.5%			(I)
	C2012X7R123KGTSC		1V, 1kHz	12	nF	±10%	0.60	±0.15	±0.15	2.5%			(I)
	C2012X7R123KGT	C2012X7R123KGT	1V, 1kHz	12	nF	±10%	0.85	±0.15	±0.15	2.5%			(I)
	C2012X7R153KGTSC		1V, 1kHz	15	nF	±10%	0.60	±0.15	±0.15	2.5%			(I)
C2012X7R153KGT	C2012X7R153KGT	1V, 1kHz	15	nF	±10%	0.85	±0.15	±0.15	2.5%	(I)			
C2012X7R183KGTSC		1V, 1kHz	18	nF	±10%	0.60	±0.15	±0.15	2.5%	(I)			
C2012X7R183KGT	C2012X7R183KGT	1V, 1kHz	18	nF	±10%	0.85	±0.15	±0.15	2.5%	(I)			
C2012X7R223KGTSC		1V, 1kHz	22	nF	±10%	0.60	±0.15	±0.15	2.5%	(I)			
C2012X7R223KGT	C2012X7R223KGT	1V, 1kHz	22	nF	±10%	0.80	±0.15	±0.15	2.5%	(I)			
C2012X7R273KGTSC		1V, 1kHz	27	nF	±10%	0.60	±0.15	±0.15	2.5%	Paper, 4Kpcs	(I)		
C2012X7R273KGT	C2012X7R273KGT	1V, 1kHz	27	nF	±10%	0.85	±0.15	±0.15	2.5%		(I)		
C2012X7R333KGTSC		1V, 1kHz	33	nF	±10%	0.60	±0.15	±0.15	2.5%		(I)		
C2012X7R333KGT	C2012X7R333KGT	1V, 1kHz	33	nF	±10%	0.85	±0.15	±0.15	2.5%		(I)		
C2012X7R393KGTSC		1V, 1kHz	39	nF	±10%	0.60	±0.15	±0.15	2.5%		(I)		
C2012X7R393KGT	C2012X7R393KGT	1V, 1kHz	39	nF	±10%	0.85	±0.15	±0.15	2.5%		(I)		
C2012X7R473KGTSC		1V, 1kHz	47	nF	±10%	0.85	±0.15	±0.15	2.5%		(I)		
C2012X7R473KGT	C2012X7R473KGT	1V, 1kHz	47	nF	±10%	0.85	±0.15	±0.15	2.5%		(I)		
C2012X7R563KGTSC		1V, 1kHz	56	nF	±10%	0.85	±0.15	±0.15	2.5%		(I)		
C2012X7R563KGT	C2012X7R563KGT	1V, 1kHz	56	nF	±10%	0.85	±0.15	±0.15	2.5%		(I)		
C2012X7R683KGTSC		1V, 1kHz	68	nF	±10%	0.85	±0.15	±0.15	2.5%	(I)			
C2012X7R683KGT	C2012X7R683KGT	1V, 1kHz	68	nF	±10%	0.85	±0.15	±0.15	2.5%	(I)			
C2012X7R823KGTSC		1V, 1kHz	82	nF	±10%	0.85	±0.15	±0.15	2.5%	(I)			
C2012X7R823KGT	C2012X7R823KGT	1V, 1kHz	82	nF	±10%	0.85	±0.15	±0.15	2.5%	(I)			
C2012X7R104KGTSD		1V, 1kHz	100	nF	±10%	0.80	±0.15	±0.10	2.5%	(I)			
C2012X7R124KGTSC		1V, 1kHz	120	nF	±10%	0.85	±0.15	±0.15	2.5%	(I)			
C2012X7R124KGT	C2012X7R124KGT	1V, 1kHz	120	nF	±10%	0.85	±0.15	±0.15	2.5%	(I)			
C2012X7R154KGTSC		1V, 1kHz	150	nF	±10%	0.85	±0.15	±0.15	2.5%	(I)			
C2012X7R154KGT	C2012X7R154KGT	1V, 1kHz	150	nF	±10%	0.85	±0.15	±0.15	2.5%	(I)			
C2012X7R184KGP		1V, 1kHz	180	nF	±10%	1.25	±0.15	±0.20	3.0%	Embossed, 3Kpcs	(I)		
C2012X7R224KGTSC		1V, 1kHz	220	nF	±10%	0.85	±0.15	±0.15	3.0%		(I)		
C2012X7R224KGP	C2012X7R224KGP	1V, 1kHz	220	nF	±10%	1.25	±0.15	±0.20	3.0%	(I)			
C2012X7R334KGP	C2012X7R334KGP	1V, 1kHz	330	nF	±10%	1.25	±0.15	±0.20	3.0%	(I)			
C2012X7R474KGP	C2012X7R474KGP	1V, 1kHz	470	nF	±10%	1.25	±0.15	±0.20	3.5%	(I)			
C2012X7R105KGP	C2012X7R105KGP	1V, 1kHz	1.0	uF	±10%	1.25	±0.15	±0.20	10.0%	(II)			
C2012X7R225KGP	C2012X7R225KGP	1V, 1kHz	2.2	uF	±10%	1.25	±0.20	±0.20	10.0%	(III)			

RV	DARFON P/N	DARFON P/N 2	Measuring Condition	Capacitance		Available Tolerance	Thick. (mm)	Tolerance(mm)		DF (max.)	Standard Packing	Test Spec.
				Value	Unit			L/W	Thick.			
35V	C2012X7R474KNPS	C2012X7R474KNP	1V, 1kHz	470	nF	±10%	1.25	±0.15	±0.20	3.5%	Embossed, 3Kpcs	(I)
	C2012X7R102KFTSC		1V, 1kHz	1.0	nF	±10%	0.60	±0.15	±0.15	3.5%		(I)
	C2012X7R102KFTS	C2012X7R102KFT	1V, 1kHz	1.0	nF	±10%	0.85	±0.15	±0.15	3.5%		(I)
	C2012X7R122KFTSC		1V, 1kHz	1.2	nF	±10%	0.60	±0.15	±0.15	3.5%		(I)
	C2012X7R122KFTS	C2012X7R122KFT	1V, 1kHz	1.2	nF	±10%	0.85	±0.15	±0.15	3.5%		(I)
	C2012X7R152KFTSC		1V, 1kHz	1.5	nF	±10%	0.60	±0.15	±0.15	3.5%		(I)
	C2012X7R152KFTS	C2012X7R152KFT	1V, 1kHz	1.5	nF	±10%	0.85	±0.15	±0.15	3.5%		(I)
	C2012X7R182KFTSC		1V, 1kHz	1.8	nF	±10%	0.60	±0.15	±0.15	3.5%		(I)
	C2012X7R182KFTS	C2012X7R182KFT	1V, 1kHz	1.8	nF	±10%	0.85	±0.15	±0.15	3.5%		(I)
	C2012X7R222KFTSC		1V, 1kHz	2.2	nF	±10%	0.60	±0.15	±0.15	3.5%		(I)
	C2012X7R222KFTS	C2012X7R222KFT	1V, 1kHz	2.2	nF	±10%	0.85	±0.15	±0.15	3.5%		(I)
	C2012X7R272KFTSC		1V, 1kHz	2.7	nF	±10%	0.60	±0.15	±0.15	3.5%		(I)
	C2012X7R272KFTS	C2012X7R272KFT	1V, 1kHz	2.7	nF	±10%	0.85	±0.15	±0.15	3.5%		(I)
	C2012X7R332KFTSC		1V, 1kHz	3.3	nF	±10%	0.60	±0.15	±0.15	3.5%		(I)
	C2012X7R332KFTS	C2012X7R332KFT	1V, 1kHz	3.3	nF	±10%	0.85	±0.15	±0.15	3.5%		(I)
	C2012X7R392KFTSC		1V, 1kHz	3.9	nF	±10%	0.60	±0.15	±0.15	3.5%		(I)
	C2012X7R392KFTS	C2012X7R392KFT	1V, 1kHz	3.9	nF	±10%	0.85	±0.15	±0.15	3.5%		(I)
	C2012X7R472KFTSC		1V, 1kHz	4.7	nF	±10%	0.60	±0.15	±0.15	3.5%		(I)
	C2012X7R472KFTS	C2012X7R472KFT	1V, 1kHz	4.7	nF	±10%	0.85	±0.15	±0.15	3.5%		(I)
	C2012X7R562KFTSC		1V, 1kHz	5.6	nF	±10%	0.60	±0.15	±0.15	3.5%		(I)
	C2012X7R562KFTS	C2012X7R562KFT	1V, 1kHz	5.6	nF	±10%	0.85	±0.15	±0.15	3.5%		(I)
	C2012X7R682KFTSC		1V, 1kHz	6.8	nF	±10%	0.60	±0.15	±0.15	3.5%		(I)
	C2012X7R682KFTS	C2012X7R682KFT	1V, 1kHz	6.8	nF	±10%	0.85	±0.15	±0.15	3.5%		(I)
	C2012X7R822KFTSC		1V, 1kHz	8.2	nF	±10%	0.60	±0.15	±0.15	3.5%		(I)
	C2012X7R103KFTSC		1V, 1kHz	10	nF	±10%	0.60	±0.15	±0.15	3.5%		(I)
	C2012X7R103KFTS	C2012X7R103KFT	1V, 1kHz	10	nF	±10%	0.85	±0.15	±0.15	3.5%		(I)
	C2012X7R123KFTSC		1V, 1kHz	12	nF	±10%	0.60	±0.15	±0.15	3.5%		(I)
	C2012X7R123KFTS	C2012X7R123KFT	1V, 1kHz	12	nF	±10%	0.85	±0.15	±0.15	3.5%		(I)
	C2012X7R153KFTSC		1V, 1kHz	15	nF	±10%	0.60	±0.15	±0.15	3.5%		(I)
	C2012X7R153KFTS	C2012X7R153KFT	1V, 1kHz	15	nF	±10%	0.85	±0.15	±0.15	3.5%		(I)
	C2012X7R183KFTSC		1V, 1kHz	18	nF	±10%	0.60	±0.15	±0.15	3.5%		(I)
	C2012X7R183KFTS	C2012X7R183KFT	1V, 1kHz	18	nF	±10%	0.85	±0.15	±0.15	3.5%		(I)
	C2012X7R223KFTSC		1V, 1kHz	22	nF	±10%	0.60	±0.15	±0.15	3.5%		(I)
	C2012X7R223KFTS	C2012X7R223KFT	1V, 1kHz	22	nF	±10%	0.85	±0.15	±0.15	3.5%		(I)
	C2012X7R273KFTSC		1V, 1kHz	27	nF	±10%	0.60	±0.15	±0.15	3.5%		(I)
C2012X7R273KFTS	C2012X7R273KFT	1V, 1kHz	27	nF	±10%	0.85	±0.15	±0.15	3.5%	(I)		
C2012X7R333KFTSC		1V, 1kHz	33	nF	±10%	0.60	±0.15	±0.15	3.5%	(I)		
C2012X7R333KFTS	C2012X7R333KFT	1V, 1kHz	33	nF	±10%	0.85	±0.15	±0.15	3.5%	(I)		
C2012X7R393KFTSC		1V, 1kHz	39	nF	±10%	0.60	±0.15	±0.15	3.5%	(I)		
C2012X7R393KFTS	C2012X7R393KFT	1V, 1kHz	39	nF	±10%	0.85	±0.15	±0.15	3.5%	(I)		
C2012X7R473KFTSC		1V, 1kHz	47	nF	±10%	0.85	±0.15	±0.15	3.5%	(I)		
C2012X7R473KFTS	C2012X7R473KFT	1V, 1kHz	47	nF	±10%	0.85	±0.15	±0.15	3.5%	(I)		
C2012X7R563KFTSC		1V, 1kHz	56	nF	±10%	0.85	±0.15	±0.15	3.5%	(I)		
C2012X7R563KFTS	C2012X7R563KFT	1V, 1kHz	56	nF	±10%	0.85	±0.15	±0.15	3.5%	(I)		
C2012X7R683KFTSC		1V, 1kHz	68	nF	±10%	0.85	±0.15	±0.15	3.5%	(I)		
C2012X7R683KFTS	C2012X7R683KFT	1V, 1kHz	68	nF	±10%	0.85	±0.15	±0.15	3.5%	(I)		
C2012X7R823KFTSC		1V, 1kHz	82	nF	±10%	0.85	±0.15	±0.15	3.5%	(I)		
C2012X7R823KFTS	C2012X7R823KFT	1V, 1kHz	82	nF	±10%	0.85	±0.15	±0.15	3.5%	(I)		
C2012X7R104KFTSC		1V, 1kHz	100	nF	±10%	0.85	±0.15	±0.15	3.5%	(I)		
C2012X7R104KFTS	C2012X7R104KFT	1V, 1kHz	100	nF	±10%	0.85	±0.15	±0.15	3.5%	(I)		
C2012X7R124KFTSC		1V, 1kHz	120	nF	±10%	0.85	±0.15	±0.15	3.5%	(I)		
C2012X7R124KFTS	C2012X7R124KFT	1V, 1kHz	120	nF	±10%	0.85	±0.15	±0.15	3.5%	(I)		
C2012X7R154KFTSC		1V, 1kHz	150	nF	±10%	0.85	±0.15	±0.15	3.5%	(I)		
C2012X7R154KFTS	C2012X7R154KFT	1V, 1kHz	150	nF	±10%	0.85	±0.15	±0.15	3.5%	(I)		
C2012X7R184KFTSC		1V, 1kHz	180	nF	±10%	0.85	±0.15	±0.20	3.5%	(I)		
C2012X7R184KFTS	C2012X7R184KFT	1V, 1kHz	180	nF	±10%	0.85	±0.15	±0.20	3.5%	(I)		
C2012X7R224KFTSC		1V, 1kHz	220	nF	±10%	0.85	±0.15	±0.15	3.5%	(I)		
C2012X7R224KFTS	C2012X7R224KFT	1V, 1kHz	220	nF	±10%	0.85	±0.15	±0.15	3.5%	(I)		
C2012X7R334KFTSC		1V, 1kHz	330	nF	±10%	1.25	±0.15	±0.20	5.0%	(I)		
C2012X7R334KFTS	C2012X7R334KFT	1V, 1kHz	330	nF	±10%	1.25	±0.15	±0.20	5.0%	(I)		
C2012X7R474KFTSC		1V, 1kHz	470	nF	±10%	1.25	±0.15	±0.20	5.0%	(I)		
C2012X7R474KFTS	C2012X7R474KFT	1V, 1kHz	470	nF	±10%	1.25	±0.15	±0.20	5.0%	(I)		
C2012X7R105□ FPS	C2012X7R105□ FP	1V, 1kHz	1.0	uF	±10%, ±20%	1.25	±0.15	±0.15	10.0%	(II)		
C2012X7R225KFTSC		1V, 1kHz	2.2	uF	±10%	1.25	±0.15	±0.20	10.0%	(II)		
C2012X7R225KFTS	C2012X7R225KFT	1V, 1kHz	2.2	uF	±10%	1.25	±0.15	±0.20	10.0%	(II)		
C2012X7R475KFTSC		1V, 1kHz	4.7	uF	±10%	1.25	±0.15	±0.15	12.5%	(II)*		
C2012X7R123KETS	C2012X7R123KET	1V, 1kHz	12	nF	±10%	0.85	±0.15	±0.15	3.5%	(I)		
C2012X7R104KETS	C2012X7R104KET	1V, 1kHz	100	nF	±10%	0.85	±0.15	±0.15	3.5%	(I)		
C2012X7R224KETS	C2012X7R224KET	1V, 1kHz	220	nF	±10%	0.85	±0.15	±0.15	3.5%	(I)		
C2012X7R224KEPS	C2012X7R224KEP	1V, 1kHz	220	nF	±10%	1.25	±0.15	±0.20	3.0%	(I)		
C2012X7R334KEPS	C2012X7R334KEP	1V, 1kHz	330	nF	±10%	1.25	±0.15	±0.20	5.0%	(I)		
C2012X7R474KEPS	C2012X7R474KEP	1V, 1kHz	470	nF	±10%	1.25	±0.15	±0.20	5.0%	(I)		
C2012X7R684KEPS	C2012X7R684KEP	1V, 1kHz	680	nF	±10%	1.25	±0.15	±0.10	5.0%	(I)		
C2012X7R105□ EPS	C2012X7R105□ EP	1V, 1kHz	1.0	uF	±10%, ±20%	1.25	±0.15	±0.20	5.0%	(I)		
C2012X7R225KEPS	C2012X7R225KEP	1V, 1kHz	2.2	uF	±10%	1.25	±0.15	±0.20	10.0%	(I)		
C2012X7R475KEPS	C2012X7R475KEP	1V, 1kHz	4.7	uF	±10%	1.25	±0.15	±0.20	10.0%	(II)		
C2012X7R106□ EPS	C2012X7R106□ EP	1V, 1kHz	10	uF	±10%, ±20%	1.25	±0.15	±0.20	10.0%	(II)*		
C2012X7R105□ DPS	C2012X7R105□ DP	1V, 1kHz	1.0	uF	±10%, ±20%	1.25	±0.15	±0.20	5.0%	(I)		
C2012X7R225KDPS	C2012X7R225KDP	1V, 1kHz	2.2	uF	±10%	1.25	±0.15	±0.20	10.0%	(II)		
C2012X7R475KDPS	C2012X7R475KDP	1V, 1kHz	4.7	uF	±10%	1.25	±0.15	±0.20	10.0%	(II)		
C2012X7R106KDPS	C2012X7R106KDP	1V, 1kHz	10	uF	±10%	1.25	±0.15	±0.20	10.0%	(II)		
C2012X7R475KCPSC		1V, 1kHz	4.7	uF	±10%	1.25	±0.15	±0.20	10.0%	(II)		
C2012X7R106□ CPS	C2012X7R106□ CP	1V, 1kHz	10	uF	±10%, ±20%	1.25	±0.15	±0.20	15.0%	(II)		
C2012X7R106□ BPS	C2012X7R106□ BP	1V, 1kHz	10	uF	±10%, ±20%	1.25	±0.15	±0.20	15.0%	(II)		

● C3216X7R Series (EIA1206)

RV	DARFON P/N	DARFON P/N 2	Measuring Condition	Capacitance		Available Tolerance	Thick. (mm)	Tolerance(mm)		DF (max.)	Standard Packing	Test Spec.	
				Value	Unit			L/W	Thick.				
50V	C3216X7R102KGT	C3216X7R102KGT	1V, 1kHz	1.0	nF	±10%	0.85	±0.15	±0.10	3.5%	Paper, 4Kpcs	(I)	
	C3216X7R562□GTS	C3216X7R562□GT	1V, 1kHz	5.6	nF	±5%, ±10%	0.85	±0.15	±0.10	3.5%		(I)	
	C3216X7R103□GTS	C3216X7R103□GT	1V, 1kHz	10	nF	±10%, ±20%	0.85	±0.15	±0.10	3.5%		(I)	
	C3216X7R123KGT	C3216X7R123KGT	1V, 1kHz	12	nF	±10%	0.85	±0.15	±0.10	3.5%		(I)	
	C3216X7R153KGT	C3216X7R153KGT	1V, 1kHz	15	nF	±10%	0.85	±0.15	±0.10	3.5%		(I)	
	C3216X7R183KGT	C3216X7R183KGT	1V, 1kHz	18	nF	±10%	0.85	±0.15	±0.10	3.5%		(I)	
	C3216X7R223KGT	C3216X7R223KGT	1V, 1kHz	22	nF	±10%	0.85	±0.15	±0.10	3.5%		(I)	
	C3216X7R273KGT	C3216X7R273KGT	1V, 1kHz	27	nF	±10%	0.85	±0.15	±0.10	3.5%		(I)	
	C3216X7R333KGT	C3216X7R333KGT	1V, 1kHz	33	nF	±10%	0.85	±0.15	±0.10	3.5%		(I)	
	C3216X7R393KGT	C3216X7R393KGT	1V, 1kHz	39	nF	±10%	0.85	±0.15	±0.10	3.5%		(I)	
	C3216X7R473KGT	C3216X7R473KGT	1V, 1kHz	47	nF	±10%	0.85	±0.15	±0.10	3.5%		(I)	
	C3216X7R563KGT	C3216X7R563KGT	1V, 1kHz	56	nF	±10%	0.85	±0.15	±0.10	3.5%		(I)	
	C3216X7R683KGT	C3216X7R683KGT	1V, 1kHz	68	nF	±10%	0.85	±0.15	±0.10	3.5%		(I)	
	C3216X7R823KGT	C3216X7R823KGT	1V, 1kHz	82	nF	±10%	0.85	±0.15	±0.10	3.5%		(I)	
	C3216X7R104KGT	C3216X7R104KGT	1V, 1kHz	100	nF	±10%	0.85	±0.15	±0.10	3.5%		(I)	
	C3216X7R224KGP	C3216X7R224KGP	1V, 1kHz	220	nF	±10%	0.95	±0.15	±0.10	3.5%		Embossed, 3Kpcs	(I)
	C3216X7R334KGP	C3216X7R334KGP	1V, 1kHz	330	nF	±10%	1.25	±0.15	±0.15	3.5%			(I)
	C3216X7R474KGP	C3216X7R474KGP	1V, 1kHz	470	nF	±10%	1.25	±0.15	±0.15	3.5%		Embossed, 2Kpcs	(I)
	C3216X7R684KGP	C3216X7R684KGP	1V, 1kHz	680	nF	±10%	1.60	+0.3/-0.1	+0.3/-0.1	3.5%			(I)
	C3216X7R105KGP	C3216X7R105KGP	1V, 1kHz	1.0	uF	±10%	1.25	±0.15	±0.15	3.5%		Embossed, 3Kpcs	(I)
C3216X7R105KGP	C3216X7R105KGP	1V, 1kHz	1.0	uF	±10%	1.60	±0.30	±0.30	3.5%	(I)			
C3216X7R225KGP	C3216X7R225KGP	1V, 1kHz	2.2	uF	±10%	1.60	±0.20	±0.20	10.0%	Embossed, 2Kpcs	(II)		
C3216X7R475KGP	C3216X7R475KGP	1V, 1kHz	4.7	uF	±10%	1.60	±0.30	±0.30	10.0%		(II)		
C3216X7R106KGP	C3216X7R106KGP	1V, 1kHz	10	uF	±10%	1.60	±0.20	±0.20	10.0%	(II)			
25V	C3216X7R224KFP	C3216X7R224KFP	1V, 1kHz	220	nF	±10%	0.95	±0.15	±0.10	3.5%	Embossed, 3Kpcs	(I)	
	C3216X7R334KFP	C3216X7R334KFP	1V, 1kHz	330	nF	±10%	0.95	±0.15	±0.10	3.5%		(I)	
	C3216X7R474KFP	C3216X7R474KFP	1V, 1kHz	470	nF	±10%	1.25	±0.15	±0.20	3.5%		(I)	
	C3216X7R105□FP	C3216X7R105□FP	1V, 1kHz	1.0	uF	±10%, ±20%	1.25	±0.15	±0.20	3.5%	Embossed, 2Kpcs	(I)	
	C3216X7R225KFP	C3216X7R225KFP	1V, 1kHz	2.2	uF	±10%	1.60	±0.30	±0.30	5.0%		(I)	
	C3216X7R475KFP	C3216X7R475KFP	1V, 1kHz	4.7	uF	±10%	1.60	±0.30	±0.30	10.0%		(II)	
C3216X7R106KFP	C3216X7R106KFP	1V, 1kHz	10	uF	±10%	1.60	±0.30	±0.30	10.0%	(II)			
16V	C3216X7R104KETS	C3216X7R104KET	1V, 1kHz	100	nF	±10%	0.85	±0.15	±0.10	3.5%	Paper, 4Kpcs	(I)	
	C3216X7R474KEPS	C3216X7R474KEP	1V, 1kHz	470	nF	±10%	1.25	±0.15	±0.20	5.0%	Embossed, 3Kpcs	(I)	
	C3216X7R105KEPS	C3216X7R105KEP	1V, 1kHz	1.0	uF	±10%	1.25	±0.15	±0.20	5.0%		(I)	
	C3216X7R225KEPS	C3216X7R225KEP	1V, 1kHz	2.2	uF	±10%	1.60	±0.30	±0.30	10.0%	(I)		
	C3216X7R475KEPS	C3216X7R475KEP	1V, 1kHz	4.7	uF	±10%	1.60	±0.30	±0.30	10.0%	(I)		
C3216X7R106□EPS	C3216X7R106□EP	1V, 1kHz	10	uF	±10%, ±20%	1.60	±0.30	±0.30	10.0%	Embossed, 2Kpcs	(II)*		
C3216X7R225KDPS	C3216X7R225KDP	1V, 1kHz	2.2	uF	±10%	1.60	±0.30	±0.30	10.0%		(I)		
10V	C3216X7R106□DPS	C3216X7R106□DP	1V, 1kHz	10	uF	±10%, ±20%	1.60	±0.30	±0.30	10.0%	Embossed, 2Kpcs	(II)	
	C3216X7R226□DPS	C3216X7R226□DP	0.5V, 120Hz	22	uF	±10%, ±20%	1.60	±0.30	±0.30	10.0%		(II)	
6.3V	C3216X7R226KCPS	C3216X7R226KCP	0.5V, 120Hz	22	uF	±10%	1.60	±0.30	±0.30	10.0%	(II)		

● C3225X7R Series (EIA1210)

RV	DARFON P/N	DARFON P/N 2	Measuring Condition	Capacitance		Available Tolerance	Thick. (mm)	Tolerance(mm)		DF (max.)	Standard Packing	Test Spec.	
				Value	Unit			L/W	Thick.				
50V	C3225X7R225MGPS	C3225X7R225MGP	1V, 1kHz	2.2	uF	±20%	2.50	±0.3/±0.2	±0.20	5.0%	Embossed, 1Kpcs	(II)	
	C3225X7R475KGPS	C3225X7R475KGP	1V, 1kHz	4.7	uF	±10%	2.50	±0.3/±0.2	±0.20	10.0%		(II)	
	C3225X7R106□GPS	C3225X7R106□GP	1V, 1kHz	10	uF	±10%, ±20%	2.50	±0.30	±0.30	10.0%		(II)	
25V	C3225X7R475KFP	C3225X7R475KFP	1V, 1kHz	4.7	uF	±10%	2.00	±0.3/±0.2	±0.20	10.0%	Embossed, 2Kpcs	(I)	
	C3225X7R106KFP	C3225X7R106KFP	1V, 1kHz	10	uF	±10%	2.00	±0.3/±0.2	±0.30	10.0%		(II)	
	C3225X7R226□FP	C3225X7R226□FP	0.5V, 120Hz	22	uF	±10%, ±20%	2.50	±0.3/±0.2	±0.20	10.0%		Embossed, 1Kpcs	(II)
16V	C3225X7R475KEPS	C3225X7R475KEP	1V, 1kHz	4.7	uF	±10%	2.50	±0.3/±0.2	±0.20	5.0%	Embossed, 1Kpcs	(II)	
	C3225X7R106KEPS	C3225X7R106KEP	1V, 1kHz	10	uF	±10%	2.00	±0.3/±0.2	±0.20	10.0%		Embossed, 2Kpcs	(I)
	C3225X7R226□EPS	C3225X7R226□EP	0.5V, 120Hz	22	uF	±10%, ±20%	2.50	±0.3/±0.2	±0.30	10.0%		Embossed, 1Kpcs	(II)
10V	C3225X7R226KDPS	C3225X7R226KDP	0.5V, 120Hz	22	uF	±10%	2.50	±0.3/±0.2	±0.20	10.0%	Embossed, 1Kpcs	(II)	
	C3225X7R476□DPS	C3225X7R476□DP	0.5V, 120Hz	47	uF	±10%, ±20%	2.50	±0.3/±0.2	±0.20	10.0%		(II)	

□ Tolerance Code: J=±5%, K=±10%, M=±20%; Special tolerance on the request.

(II)* High temperature load life test are applicable in rated voltage *100%

■ X7S Series

● C0603X7S Series (EIA0201)

RV	DARFON P/N	DARFON P/N 2	Measuring Condition	Capacitance		Available Tolerance	Thick. (mm)	Tolerance(mm)		DF (max.)	Standard Packing	Test Spec.
				Value	Unit			L/W	Thick.			
10V	C0603X7S104KDTS	C0603X7S104KDT	1V, 1kHz	100	nF	±10%	0.30	± 0.03	±0.03	10.0%	Paper, 15Kpcs	(II)

● C1005X7S Series (EIA0402)

RV	DARFON P/N	DARFON P/N 2	Measuring Condition	Capacitance		Available Tolerance	Thick. (mm)	Tolerance(mm)		DF (max.)	Standard Packing	Test Spec.
				Value	Unit			L/W	Thick.			
10V	C1005X7S105KDTS	C1005X7S105KDT	1V, 1kHz	1.0	uF	±10%	0.50	± 0.10	±0.10	10.0%	Paper, 10Kpcs	(II)
	C1005X7S225KDTS	C1005X7S225KDT	1V, 1kHz	2.2	uF	±10%	0.50	± 0.20	±0.20	10.0%		(II)
6.3V	C1005X7S225KCTS	C1005X7S225KCT	1V, 1kHz	2.2	uF	±10%	0.50	± 0.20	±0.20	10.0%		(II)

● C1608X7S Series (EIA0603)

RV	DARFON P/N	DARFON P/N 2	Measuring Condition	Capacitance		Available Tolerance	Thick. (mm)	Tolerance(mm)		DF (max.)	Standard Packing	Test Spec.
				Value	Unit			L/W	Thick.			
16V	C1608X7S225KETS	C1608X7S225KET	1V, 1kHz	2.2	uF	±10%	0.80	± 0.20	±0.20	10.0%	Paper, 4Kpcs	(II)
	C1608X7S475KETS	C1608X7S475KET	1V, 1kHz	4.7	uF	±10%	0.80	± 0.20	±0.20	10.0%		(II)
10V	C1608X7S475KDTS	C1608X7S475KDT	1V, 1kHz	4.7	uF	±10%	0.80	± 0.15	±0.15	10.0%		(II)

● C2012X7S Series (EIA0805)

RV	DARFON P/N	DARFON P/N 2	Measuring Condition	Capacitance		Available Tolerance	Thick. (mm)	Tolerance(mm)		DF (max.)	Standard Packing	Test Spec.
				Value	Unit			L/W	Thick.			
50V	C2012X7S475KGPS	C2012X7S475KGP	1V, 1kHz	4.7	uF	±10%	1.25	± 0.20	±0.20	10.0%	Embossed, 3Kpcs	(II)
25V	C2012X7S225KFPS	C2012X7S225KFP	1V, 1kHz	2.2	uF	±10%	1.25	± 0.15	±0.15	10.0%		(II)
	C2012X7S106KFPS	C2012X7S106KFP	1V, 1kHz	10	uF	±10%	1.25	± 0.20	±0.20	10.0%		(II)*

● C3225X7S Series (EIA1210)

RV	DARFON P/N	DARFON P/N 2	Measuring Condition	Capacitance		Available Tolerance	Thick. (mm)	Tolerance(mm)		DF (max.)	Standard Packing	Test Spec.
				Value	Unit			L/W	Thick.			
6.3V	C3225X7S107MCPS	C3225X7S107MCP	0.5V, 120Hz	100	uF	±20%	2.50	± 0.30	±0.30	10.0%	Embossed, 1Kpcs	(II)*

□ Tolerance Code: K=±10%, M=±20%; Special tolerance on the request.

(II)* High temperature load life test are applicable in rated voltage *100%

- X7T Series
- C2012X7T Series (EIA0805)

RV	DARFON P/N	DARFON P/N 2	Measuring Condition	Capacitance		Available Tolerance	Thick. (mm)	Tolerance(mm)		DF (max.)	Standard Packing	Test Spec.
				Value	Unit			L/W	Thick.			
10V	C2012X7T226MDPS	C2012X7T226MDP	0.5V , 120Hz	22	uF	±20%	1.25	± 0.20	±0.20	10.0%	Embossed, 3Kpcs	(II)*

□ Tolerance Code: K=±10%, M=±20%; Special tolerance on the request.

(II)* High temperature load life test are applicable in rated voltage *100%

- X7U Series
- C3216X7U Series (EIA1206)

RV	DARFON P/N	DARFON P/N 2	Measuring Condition	Capacitance		Available Tolerance	Thick. (mm)	Tolerance(mm)		DF (max.)	Standard Packing	Test Spec.
				Value	Unit			L/W	Thick.			
4V	C3216X7U107MBPS	C3216X7U107MBP	0.5V , 120Hz	100	uF	±20%	1.6	± 0.30	±0.30	15.0%	Embossed, 2Kpcs	(II)*

□ Tolerance Code: K=±10%, M=±20%; Special tolerance on the request.

(II)* High temperature load life test are applicable in rated voltage *100%

■ Y5V Series

● C1005Y5V Series (EIA0402)

RV	DARFON P/N	DARFON P/N 2	Measuring Condition	Capacitance		Available Tolerance	Thick. (mm)	Tolerance(mm)		DF (max.)	Standard Packing	Test Spec.
				Value	Unit			L/W	Thick.			
50V	C1005Y5V103ZGTS	C1005Y5V103ZGT	1V, 1kHz	10	nF	+80%/-20%	0.50	±0.05	±0.05	7.0%	Paper, 10Kpcs	(I)
	C1005Y5V223ZGTS	C1005Y5V223ZGT	1V, 1kHz	22	nF	+80%/-20%	0.50	±0.05	±0.05	9.0%		(I)
25V	C1005Y5V103ZFTS	C1005Y5V103ZFT	1V, 1kHz	10	nF	+80%/-20%	0.50	±0.05	±0.05	9.0%		(I)
	C1005Y5V223ZFTS	C1005Y5V223ZFT	1V, 1kHz	22	nF	+80%/-20%	0.50	±0.05	±0.05	9.0%		(I)
	C1005Y5V473ZFTS	C1005Y5V473ZFT	1V, 1kHz	47	nF	+80%/-20%	0.50	±0.05	±0.05	9.0%		(I)
16V	C1005Y5V104ZFTS	C1005Y5V104ZFT	1V, 1kHz	100	nF	+80%/-20%	0.50	±0.05	±0.05	9.0%		(I)
	C1005Y5V224ZETS	C1005Y5V224ZET	1V, 1kHz	220	nF	+80%/-20%	0.50	±0.05	±0.05	9.0%		(II)
10V	C1005Y5V474ZETS	C1005Y5V474ZET	1V, 1kHz	470	nF	+80%/-20%	0.50	±0.05	±0.05	12.5%		(II)
	C1005Y5V224ZDTS	C1005Y5V224ZDT	1V, 1kHz	220	nF	+80%/-20%	0.50	±0.05	±0.05	12.5%		(I)
	C1005Y5V334ZDTS	C1005Y5V334ZDT	1V, 1kHz	330	nF	+80%/-20%	0.50	±0.05	±0.05	16.0%		(I)
	C1005Y5V474ZDTS	C1005Y5V474ZDT	1V, 1kHz	470	nF	+80%/-20%	0.50	±0.05	±0.05	16.0%		(I)
	C1005Y5V105ZDTS	C1005Y5V105ZDT	1V, 1kHz	1.0	uF	+80%/-20%	0.50	±0.05	±0.05	16.0%		(II)
6.3V	C1005Y5V224ZCTS	C1005Y5V224ZCT	1V, 1kHz	220	nF	+80%/-20%	0.50	±0.05	±0.05	12.5%	(I)	
	C1005Y5V334ZCTS	C1005Y5V334ZCT	1V, 1kHz	330	nF	+80%/-20%	0.50	±0.05	±0.05	16.0%	(I)	
	C1005Y5V474ZCTS	C1005Y5V474ZCT	1V, 1kHz	470	nF	+80%/-20%	0.50	±0.05	±0.05	16.0%	(I)	
	C1005Y5V105ZCTS	C1005Y5V105ZCT	1V, 1kHz	1.0	uF	+80%/-20%	0.50	±0.05	±0.05	16.0%	(I)	

● C1608Y5V Series (EIA0603)

RV	DARFON P/N	DARFON P/N 2	Measuring Condition	Capacitance		Available Tolerance	Thick. (mm)	Tolerance(mm)		DF (max.)	Standard Packing	Test Spec.
				Value	Unit			L/W	Thick.			
50V	C1608Y5V103ZGTS	C1608Y5V103ZGT	1V, 1kHz	10	nF	+80%/-20%	0.80	±0.10	±0.10	5.0%	Paper, 4kpcs	(I)
	C1608Y5V123ZGTS	C1608Y5V123ZGT	1V, 1kHz	12	nF	+80%/-20%	0.80	±0.10	±0.10	5.0%		(I)
	C1608Y5V153ZGTS	C1608Y5V153ZGT	1V, 1kHz	15	nF	+80%/-20%	0.80	±0.10	±0.10	5.0%		(I)
	C1608Y5V183ZGTS	C1608Y5V183ZGT	1V, 1kHz	18	nF	+80%/-20%	0.80	±0.10	±0.10	5.0%		(I)
	C1608Y5V223ZGTS	C1608Y5V223ZGT	1V, 1kHz	22	nF	+80%/-20%	0.80	±0.10	±0.10	5.0%		(I)
	C1608Y5V273ZGTS	C1608Y5V273ZGT	1V, 1kHz	27	nF	+80%/-20%	0.80	±0.10	±0.10	5.0%		(I)
	C1608Y5V333ZGTS	C1608Y5V333ZGT	1V, 1kHz	33	nF	+80%/-20%	0.80	±0.10	±0.10	5.0%		(I)
	C1608Y5V393ZGTS	C1608Y5V393ZGT	1V, 1kHz	39	nF	+80%/-20%	0.80	±0.10	±0.10	5.0%		(I)
	C1608Y5V473ZGTS	C1608Y5V473ZGT	1V, 1kHz	47	nF	+80%/-20%	0.80	±0.10	±0.10	5.0%		(I)
	C1608Y5V563ZGTS	C1608Y5V563ZGT	1V, 1kHz	56	nF	+80%/-20%	0.80	±0.10	±0.10	5.0%		(I)
	C1608Y5V683ZGTS	C1608Y5V683ZGT	1V, 1kHz	68	nF	+80%/-20%	0.80	±0.10	±0.10	5.0%		(I)
	C1608Y5V823ZGTS	C1608Y5V823ZGT	1V, 1kHz	82	nF	+80%/-20%	0.80	±0.10	±0.10	5.0%		(I)
	C1608Y5V104ZGTS	C1608Y5V104ZGT	1V, 1kHz	100	nF	+80%/-20%	0.80	±0.10	±0.10	7.0%		(I)
	C1608Y5V224ZGTS	C1608Y5V224ZGT	1V, 1kHz	220	nF	+80%/-20%	0.80	±0.10	±0.10	9.0%		(I)
	C1608Y5V474ZGTS	C1608Y5V474ZGT	1V, 1kHz	470	nF	+80%/-20%	0.80	±0.15	±0.15	9.0%		(I)
	25V	C1608Y5V103ZFTS	C1608Y5V103ZFT	1V, 1kHz	10	nF	+80%/-20%	0.80	±0.10	±0.10		5.0%
C1608Y5V123ZFTS		C1608Y5V123ZFT	1V, 1kHz	12	nF	+80%/-20%	0.80	±0.10	±0.10	5.0%	(I)	
C1608Y5V153ZFTS		C1608Y5V153ZFT	1V, 1kHz	15	nF	+80%/-20%	0.80	±0.10	±0.10	5.0%	(I)	
C1608Y5V183ZFTS		C1608Y5V183ZFT	1V, 1kHz	18	nF	+80%/-20%	0.80	±0.10	±0.10	5.0%	(I)	
C1608Y5V223ZFTS		C1608Y5V223ZFT	1V, 1kHz	22	nF	+80%/-20%	0.80	±0.10	±0.10	5.0%	(I)	
C1608Y5V273ZFTS		C1608Y5V273ZFT	1V, 1kHz	27	nF	+80%/-20%	0.80	±0.10	±0.10	5.0%	(I)	
C1608Y5V333ZFTS		C1608Y5V333ZFT	1V, 1kHz	33	nF	+80%/-20%	0.80	±0.10	±0.10	5.0%	(I)	
C1608Y5V393ZFTS		C1608Y5V393ZFT	1V, 1kHz	39	nF	+80%/-20%	0.80	±0.10	±0.10	5.0%	(I)	
C1608Y5V473ZFTS		C1608Y5V473ZFT	1V, 1kHz	47	nF	+80%/-20%	0.80	±0.10	±0.10	5.0%	(I)	
C1608Y5V563ZFTS		C1608Y5V563ZFT	1V, 1kHz	56	nF	+80%/-20%	0.80	±0.10	±0.10	5.0%	(I)	
C1608Y5V683ZFTS		C1608Y5V683ZFT	1V, 1kHz	68	nF	+80%/-20%	0.80	±0.10	±0.10	5.0%	(I)	
C1608Y5V823ZFTS		C1608Y5V823ZFT	1V, 1kHz	82	nF	+80%/-20%	0.80	±0.10	±0.10	5.0%	(I)	
C1608Y5V104ZFTS		C1608Y5V104ZFT	1V, 1kHz	100	nF	+80%/-20%	0.80	±0.10	±0.10	7.0%	(I)	
C1608Y5V224ZFTS		C1608Y5V224ZFT	1V, 1kHz	220	nF	+80%/-20%	0.80	±0.10	±0.10	9.0%	(I)	
C1608Y5V334ZFTS		C1608Y5V334ZFT	1V, 1kHz	330	nF	+80%/-20%	0.80	±0.10	±0.10	9.0%	(I)	
C1608Y5V684ZFTS		C1608Y5V684ZFT	1V, 1kHz	680	nF	+80%/-20%	0.80	±0.15	±0.15	9.0%	(I)	
C1608Y5V105ZFTS	C1608Y5V105ZFT	1V, 1kHz	1.0	uF	+80%/-20%	0.80	±0.15	±0.15	10.0%	(II)		
16V	C1608Y5V103ZETS	C1608Y5V103ZET	1V, 1kHz	10	nF	+80%/-20%	0.80	±0.10	±0.10	7.0%	Paper, 4kpcs	(I)
	C1608Y5V123ZETS	C1608Y5V123ZET	1V, 1kHz	12	nF	+80%/-20%	0.80	±0.10	±0.10	7.0%		(I)
	C1608Y5V153ZETS	C1608Y5V153ZET	1V, 1kHz	15	nF	+80%/-20%	0.80	±0.10	±0.10	7.0%		(I)
	C1608Y5V183ZETS	C1608Y5V183ZET	1V, 1kHz	18	nF	+80%/-20%	0.80	±0.10	±0.10	7.0%		(I)
	C1608Y5V223ZETS	C1608Y5V223ZET	1V, 1kHz	22	nF	+80%/-20%	0.80	±0.10	±0.10	7.0%		(I)
	C1608Y5V273ZETS	C1608Y5V273ZET	1V, 1kHz	27	nF	+80%/-20%	0.80	±0.10	±0.10	7.0%		(I)
	C1608Y5V333ZETS	C1608Y5V333ZET	1V, 1kHz	33	nF	+80%/-20%	0.80	±0.10	±0.10	7.0%		(I)
	C1608Y5V393ZETS	C1608Y5V393ZET	1V, 1kHz	39	nF	+80%/-20%	0.80	±0.10	±0.10	7.0%		(I)
	C1608Y5V473ZETS	C1608Y5V473ZET	1V, 1kHz	47	nF	+80%/-20%	0.80	±0.10	±0.10	7.0%		(I)
	C1608Y5V563ZETS	C1608Y5V563ZET	1V, 1kHz	56	nF	+80%/-20%	0.80	±0.10	±0.10	7.0%		(I)
	C1608Y5V683ZETS	C1608Y5V683ZET	1V, 1kHz	68	nF	+80%/-20%	0.80	±0.10	±0.10	7.0%		(I)
	C1608Y5V823ZETS	C1608Y5V823ZET	1V, 1kHz	82	nF	+80%/-20%	0.80	±0.10	±0.10	7.0%		(I)
	C1608Y5V104ZETS	C1608Y5V104ZET	1V, 1kHz	100	nF	+80%/-20%	0.80	±0.10	±0.10	7.0%		(I)
	C1608Y5V224ZETS	C1608Y5V224ZET	1V, 1kHz	220	nF	+80%/-20%	0.80	±0.10	±0.10	9.0%		(I)
	C1608Y5V334ZETS	C1608Y5V334ZET	1V, 1kHz	330	nF	+80%/-20%	0.80	±0.10	±0.10	12.5%		(I)
	C1608Y5V474ZETS	C1608Y5V474ZET	1V, 1kHz	470	nF	+80%/-20%	0.80	±0.10	±0.10	12.5%		(I)
	C1608Y5V684ZETS	C1608Y5V684ZET	1V, 1kHz	680	nF	+80%/-20%	0.80	±0.10	±0.10	12.5%		(I)
	C1608Y5V824ZETS	C1608Y5V824ZET	1V, 1kHz	820	nF	+80%/-20%	0.80	+0.15/-0.10	+0.15/-0.10	12.5%		(I)
	C1608Y5V105ZETS	C1608Y5V105ZET	1V, 1kHz	1.0	uF	+80%/-20%	0.80	+0.15/-0.10	+0.15/-0.10	12.5%		(I)
	C1608Y5V225ZETS	C1608Y5V225ZET	1V, 1kHz	2.2	uF	+80%/-20%	0.80	+0.15/-0.10	+0.15/-0.10	12.5%		(II)

□ Tolerance Code: M=±20%; Special tolerance on the request.

RV	DARFON P/N	DARFON P/N 2	Measuring Condition	Capacitance		Available Tolerance	Thick. (mm)	Tolerance(mm)		DF (max.)	Standard Packing	Test Spec.
				Value	Unit			L/W	Thick.			
10V	C1608Y5V104ZDTS	C1608Y5V104ZDT	1V, 1kHz	100	nF	+80%/-20%	0.80	±0.10	±0.10	12.5%	Paper, 4kpcs	(I)
	C1608Y5V224ZDTS	C1608Y5V224ZDT	1V, 1kHz	220	nF	+80%/-20%	0.80	±0.10	±0.10	12.5%		(II)
	C1608Y5V334ZDTS	C1608Y5V334ZDT	1V, 1kHz	330	nF	+80%/-20%	0.80	±0.10	±0.10	12.5%		(II)
	C1608Y5V474ZDTS	C1608Y5V474ZDT	1V, 1kHz	470	nF	+80%/-20%	0.80	±0.10	±0.10	12.5%		(II)
	C1608Y5V105ZDTS	C1608Y5V105ZDT	1V, 1kHz	1.0	uF	+80%/-20%	0.80	+0.15/-0.10	+0.15/-0.10	12.5%		(II)
6.3V	C1608Y5V104ZCTS	C1608Y5V104ZCT	1V, 1kHz	100	nF	+80%/-20%	0.80	±0.10	±0.10	12.5%	Paper, 4kpcs	(I)
	C1608Y5V224ZCTS	C1608Y5V224ZCT	1V, 1kHz	220	nF	+80%/-20%	0.80	±0.10	±0.10	12.5%		(I)
	C1608Y5V334ZCTS	C1608Y5V334ZCT	1V, 1kHz	330	nF	+80%/-20%	0.80	±0.10	±0.10	12.5%		(I)
	C1608Y5V474ZCTS	C1608Y5V474ZCT	1V, 1kHz	470	nF	+80%/-20%	0.80	±0.10	±0.10	12.5%		(I)
	C1608Y5V105ZCTS	C1608Y5V105ZCT	1V, 1kHz	1.0	uF	+80%/-20%	0.80	+0.15/-0.10	+0.15/-0.10	12.5%		(I)
	C1608Y5V225ZCTS	C1608Y5V225ZCT	1V, 1kHz	2.2	uF	+80%/-20%	0.80	+0.15/-0.10	+0.15/-0.10	12.5%		(I)
	C1608Y5V475ZCTS	C1608Y5V475ZCT	1V, 1kHz	4.7	uF	+80%/-20%	0.80	+0.15/-0.10	+0.15/-0.10	12.5%		(II)

● C2012Y5V Series (EIA0805)

RV	DARFON P/N	DARFON P/N 2	Measuring Condition	Capacitance		Available Tolerance	Thick. (mm)	Tolerance(mm)		DF (max.)	Standard Packing
				Value	Unit			L/W	Thick.		
50V	C2012Y5V104ZGTS	C2012Y5V104ZGT	1V, 1kHz	100	nF	+80%/-20%	0.60	±0.15±0.10	±0.10	5.0%	Paper, 4Kpcs
	C2012Y5V224ZGTS	C2012Y5V224ZGT	1V, 1kHz	220	nF	+80%/-20%	0.60	±0.15±0.10	±0.10	5.0%	
	C2012Y5V334ZGTS	C2012Y5V334ZGT	1V, 1kHz	330	nF	+80%/-20%	0.80	±0.15±0.10	±0.10	5.0%	
	C2012Y5V474ZGTS	C2012Y5V474ZGT	1V, 1kHz	470	nF	+80%/-20%	0.80	±0.15±0.10	±0.10	7.0%	
	C2012Y5V105ZGPS	C2012Y5V105ZGP	1V, 1kHz	1.0	uF	+80%/-20%	1.25	±0.20	±0.20	9.0%	Embossed, 3Kpcs
25V	C2012Y5V104ZFTS	C2012Y5V104ZFT	1V, 1kHz	100	nF	+80%/-20%	0.60	±0.15±0.10	±0.10	5.0%	Paper, 4Kpcs
	C2012Y5V224ZFTS	C2012Y5V224ZFT	1V, 1kHz	220	nF	+80%/-20%	0.60	±0.15±0.10	±0.10	5.0%	
	C2012Y5V474ZFTS	C2012Y5V474ZFT	1V, 1kHz	470	nF	+80%/-20%	0.80	±0.15±0.10	±0.10	7.0%	
	C2012Y5V105ZFTS	C2012Y5V105ZFT	1V, 1kHz	1.0	uF	+80%/-20%	0.85	±0.20	±0.15	9.0%	Embossed, 3Kpcs
	C2012Y5V105ZFPS	C2012Y5V105ZFP	1V, 1kHz	1.0	uF	+80%/-20%	1.25	±0.15±0.10	±0.20	7.0%	
	C2012Y5V225ZFPS	C2012Y5V225ZFP	1V, 1kHz	2.2	uF	+80%/-20%	1.25	±0.20	±0.20	10.0%	
16V	C2012Y5V104ZETS	C2012Y5V104ZET	1V, 1kHz	100	nF	+80%/-20%	0.60	±0.15±0.10	±0.10	5.0%	Paper, 4Kpcs
	C2012Y5V224ZETS	C2012Y5V224ZET	1V, 1kHz	220	nF	+80%/-20%	0.60	±0.15±0.10	±0.10	5.0%	
	C2012Y5V474ZETS	C2012Y5V474ZET	1V, 1kHz	470	nF	+80%/-20%	0.80	±0.15±0.10	±0.10	7.0%	
	C2012Y5V105ZETS	C2012Y5V105ZET	1V, 1kHz	1.0	uF	+80%/-20%	0.85	±0.20	±0.15	9.0%	
	C2012Y5V225ZETS	C2012Y5V225ZET	1V, 1kHz	2.2	uF	+80%/-20%	1.25	±0.20	±0.15	12.5%	Embossed, 3Kpcs
	C2012Y5V475ZEPS	C2012Y5V475ZEP	1V, 1kHz	4.7	uF	+80%/-20%	1.25	±0.15±0.10	±0.10	12.5%	
	C2012Y5V106ZEPS	C2012Y5V106ZEP	1V, 1kHz	10.0	uF	+80%/-20%	1.25	±0.20	±0.20	12.5%	
10V	C2012Y5V475ZDPS	C2012Y5V475ZDP	1V, 1kHz	4.7	uF	+80%/-20%	1.25	±0.15±0.10	±0.10	12.5%	Embossed, 3Kpcs
	C2012Y5V106ZDPS	C2012Y5V106ZDP	1V, 1kHz	10	uF	+80%/-20%	1.25	±0.20	±0.20	12.5%	

● C3216Y5V Series (EIA1206)

RV	DARFON P/N	DARFON P/N 2	Measuring Condition	Capacitance		Available Tolerance	Thick. (mm)	Tolerance(mm)		DF (max.)	Standard Packing	Test Spec.
				Value	Unit			L/W	Thick.			
50V	C3216Y5V105ZGPS	C3216Y5V105ZGP	1V, 1kHz	1.0	uF	+80%/-20%	0.95	±0.15±0.20	±0.15	7.0%	Embossed, 3kpcs	(I)
	C3216Y5V475ZGPS	C3216Y5V475ZGP	1V, 1kHz	4.7	uF	+80%/-20%	1.60	±0.30	±0.30	9.0%	Embossed, 2kpcs	(I)
35V	C3216Y5V475ZNPS	C3216Y5V475ZNP	1V, 1kHz	4.7	uF	+80%/-20%	1.15	±0.20	±0.15	12.5%	Embossed, 3kpcs	(II)*
	C3216Y5V225ZFPS	C3216Y5V225ZFP	1V, 1kHz	2.2	uF	+80%/-20%	0.95	±0.15±0.20	±0.15	9.0%		(I)
25V	C3216Y5V475ZFP	C3216Y5V475ZFP	1V, 1kHz	4.7	uF	+80%/-20%	1.15	±0.20	±0.15	9.0%	Embossed, 2kpcs	(I)
	C3216Y5V106ZFP	C3216Y5V106ZFP	1V, 1kHz	10	uF	+80%/-20%	1.60	±0.30	±0.30	12.5%		(II)
	C3216Y5V475ZETS	C3216Y5V475ZET	1V, 1kHz	4.7	uF	+80%/-20%	0.85	±0.30±0.20	±0.10	12.5%	Paper, 4kpcs	(II)
16V	C3216Y5V475ZEPS	C3216Y5V475ZEP	1V, 1kHz	4.7	uF	+80%/-20%	1.15	±0.20	±0.15	12.5%	Embossed, 3kpcs	(I)
	C3216Y5V106ZEPS	C3216Y5V106ZEP	1V, 1kHz	10	uF	+80%/-20%	1.15	±0.20	±0.20	12.5%		(I)
	C3216Y5V226ZEPS	C3216Y5V226ZEP	0.5V, 120Hz	22	uF	+80%/-20%	1.60	±0.30	±0.30	12.5%	Embossed, 2kpcs	(I)
10V	C3216Y5V475ZDPS	C3216Y5V475ZDP	1V, 1kHz	4.7	uF	+80%/-20%	1.15	±0.20	±0.15	12.5%	Embossed, 3kpcs	(I)
	C3216Y5V226ZDPS	C3216Y5V226ZDP	0.5V, 120Hz	22	uF	+80%/-20%	1.60	±0.30	±0.30	20.0%	Embossed, 2kpcs	(II)

● C3225Y5V Series (EIA1210)

RV	DARFON P/N	DARFON P/N 2	Measuring Condition	Capacitance		Available Tolerance	Thick. (mm)	Tolerance(mm)		DF (max.)	Standard Packing	Test Spec.
				Value	Unit			L/W	Thick.			
35V	C3225Y5V106ZNPS	C3225Y5V106ZNP	1V, 1kHz	10	uF	+80%/-20%	1.60	±0.20	±0.20	9.0%	Embossed, 2kpcs	(I)
16V	C3225Y5V226ZEPS	C3225Y5V226ZEP	0.5V, 120Hz	22	uF	+80%/-20%	2.00	±0.30±0.20	±0.30	16.0%		(I)
6.3V	C3225Y5V476ZCWS	C3225Y5V476ZCW	0.5V, 120Hz	47	uF	+80%/-20%	2.00	±0.40±0.30	±0.20	20.0%		Embossed, 1kpcs

(II)* High temperature load life test are applicable in rated voltage *100%

- Test Spec.
- General Purpose (I)

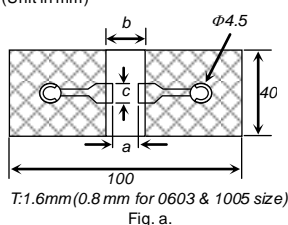
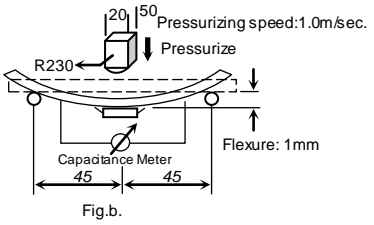
Item	Specification		Test Method																																
	Temp. compensation type	High dielectric constant type																																	
1	Operation Temperature Range	NP0: -55 to 125 °C X5R: -55 to 85 °C X6S: -55 to 105 °C X7R/X7S/X7T/X7U : -55 to 125 °C Y5V: -30 to 85 °C	---																																
2	Rated Voltage	Shown in the table of "Part Number & Characteristic"	The rated voltage is defined as the maximum voltage, which may be applied continuously to the capacitor.																																
3	Appearance	No defects or abnormalities.	Visual inspection																																
4	Dimensions	Within the specified dimension.	Using calipers																																
5	Dielectric Strength	No defects or abnormalities.	No failure shall be observed when 250% of the rated voltage is applied between the terminations for 1 to 5 seconds. The charge and discharge current is less than 50mA.																																
6	Insulation Resistance (I.R.)	To apply rated voltage. I.R. $\geq 10G\Omega$ or $R_1C_R \geq 500\Omega \cdot F$ (whichever is smaller)	The insulation resistance shall be measured with a DC voltage not exceeding the rated voltage at 25°C and 75%RH max, and within 1 minute of charging.																																
7	Capacitance	Within the specified tolerance * X5R, X6S, X7RS, X7S, X7T, X7U and Y5V at 1000 hours	The capacitance / D.F. shall be measured at 25°C at the frequency and voltage shown in the table of "Part Number & Characteristic".																																
8	Q/Dissipation Factor (D.F.)	NP0: If $C \leq 30pF$, $DF \leq 1/(400+20C)$, C in pF If $C > 30pF$, $DF \leq 0.1\%$.	Shown in the table of "Part Number & Characteristic"																																
9	Capacitance Temperature Characteristics	Capacitance change NP0 within $0 \pm 30ppm/^\circ C$ under operating temperature range. X5R/X7R within $\pm 15\%$ X6S/X7S within $\pm 22\%$ X7T: -33% to + 22% X7U: -56% to + 22% Y5V: -82 to + 22%	1. Temperature compensation type: The capacitance value at 25°C and 85°C shall be measured and calculated from the formula given below. $T.C. = (C_{85} - C_{25}) / C_{25} \cdot \Delta T \cdot 10^6 (PPM/^\circ C)$ 2. High dielectric constant type: The ranges of capacitance change compared with the 25°C value over the temperature ranges shall be within the specified ranges.																																
10	Termination Strength	No removal of the terminations or marking defect.	Apply a parallel force of 5N to a PCB mounted sample for $10 \pm 1sec$. *2N for 0603 (EIA 0201).																																
11	Deflection (Bending Strength)	No cracking or marking defects shall occur at 1mm deflection. Capacitance change: NP0: within $\pm 5\%$ or $\pm 0.5pF$. (whichever is larger) X5R, X6S, X7R, X7S, X7T, X7U: within $\pm 12.5\%$ Y5V: within $\pm 20\%$	Solder the capacitor to the test jig (glass epoxy boards) shown in Fig.a using a SAC305(Sn96.5Ag3.0Cu0.5) solder (then let sit for 24 ± 2 hours for X5R, X6S, X7R, X7S, X7T, X7U and Y5V). Then apply a force in the direction shown in Fig.b. The soldering shall be done with the reflow method and shall be conducted with care so that the soldering is uniform and free of defects such as heat shock.																																
		(Unit in mm)  <table border="1" data-bbox="774 1400 981 1590"> <thead> <tr> <th>Size</th> <th>a</th> <th>b</th> <th>C</th> </tr> </thead> <tbody> <tr> <td>0603</td> <td>0.3</td> <td>0.9</td> <td>0.3</td> </tr> <tr> <td>1005</td> <td>0.4</td> <td>1.5</td> <td>0.5</td> </tr> <tr> <td>1608</td> <td>1.0</td> <td>3.0</td> <td>1.2</td> </tr> <tr> <td>2012</td> <td>1.2</td> <td>4.0</td> <td>1.65</td> </tr> <tr> <td>3216</td> <td>2.2</td> <td>5.0</td> <td>2.0</td> </tr> <tr> <td>4520</td> <td>3.5</td> <td>7.0</td> <td>2.5</td> </tr> <tr> <td>4532</td> <td>3.5</td> <td>7.0</td> <td>3.7</td> </tr> </tbody> </table> 	Size	a	b	C	0603	0.3	0.9	0.3	1005	0.4	1.5	0.5	1608	1.0	3.0	1.2	2012	1.2	4.0	1.65	3216	2.2	5.0	2.0	4520	3.5	7.0	2.5	4532	3.5	7.0	3.7	
Size	a	b	C																																
0603	0.3	0.9	0.3																																
1005	0.4	1.5	0.5																																
1608	1.0	3.0	1.2																																
2012	1.2	4.0	1.65																																
3216	2.2	5.0	2.0																																
4520	3.5	7.0	2.5																																
4532	3.5	7.0	3.7																																
12	Solderability of Termination	90% of the terminations are to be soldered evenly and continuously.	Immerse the test capacitor into a methanol solution containing rosin for 3 to 5 seconds, preheat it 150 to 180°C for 2 to 3 minutes and immerse it into SAC305(Sn96.5Ag3.0Cu0.5) solder of $245 \pm 5^\circ C$ for 3 ± 1 seconds.																																
13	Resistance to Soldering Heat	Appearance	No marking defects	*Preheat the capacitor at 120 to 150°C for 1 minute.																															
		Cap. Change	NP0 within $\pm 2.5\%$ or 0.25pF (whichever is larger) X5R/X6S/X7R/X7S/X7T/X7U within $\pm 7.5\%$ Y5V within $\pm 20\%$	Immerse the capacitor in a SAC305(Sn96.5Ag3.0Cu0.5) solder solution at $270 \pm 5^\circ C$ for 10 ± 1 seconds. Let sit at room temperature for 24 ± 2 hours, then measure.																															
		Q/D.F.	If $C \leq 30pF$, $DF \leq 1/(400+20C)$ If $C > 30pF$, $DF \leq 0.1\%$	To satisfy the specified initial spec.	* Preheat 150 to 200°C for size ≥ 3216 .																														
		I.R.	I.R. $\geq 10,000M\Omega$ or $R_1C_R \geq 500\Omega \cdot F$ (whichever is smaller)	I.R. $\geq 10,000M\Omega$ or $R_1C_R \geq 500\Omega \cdot F$ (whichever is smaller)	*High dielectric constant type: Initial measurement : perform a heat treatment at $150 \pm 0/-10^\circ C$ for one hour and then let sit for 24 ± 2 hours at room temperature. Perform the initial measurement.																														

	Item	Specification		Test Method	
		Temp. compensation type	High dielectric constant type		
14	Temperature cycle (Thermal shock)	Appearance	No marking defects		Solder the capacitor to supporting jig (Glass epoxy board) and perform the five cycles according to the four heat treatments listed in the following table. Let sit for 24±2hrs at room temperature, then measure. Step 1: Minimum operating temperature 30±3min Step 2: Room temperature 2-3 min Step 3: Maximum operating temperature 30±3min Step 4: Room temperature 2-3min *High dielectric constant type: Initial measurement: perform a heat treatment at 150±10 °C for one hour and then let sit for 24±2 hours at room temp. Perform the initial measurement.
		Cap. Change	NP0 within ±2.5% or 0.25pF (whichever is larger)	X5R/X6S/X7R/X7S/X7T within ±7.5% X7U within ±30% Y5V within ±20%	
		Q/D.F.	If C ≤ 30pF, DF ≤ 1/(400+20C) If C > 30pF, DF ≤ 0.1%	To satisfy the specified initial spec.	
		I.R.	I.R. ≥ 10GΩ or R _C R ≥ 500Ω-F. (whichever is smaller)	I.R. ≥ 10GΩ or R _C R ≥ 500Ω-F. (whichever is smaller)	
15	Humidity load	Appearance	No marking defects		Apply the rated voltage at 40±2 °C and 90 to 95% humidity for 500±12 hours. The charge / discharge current is less than 50mA. [Temperature compensation type] Remove and let sit for 24±2 hours at room temperature, then measure. [High dielectric constant type] *Initial measurement Perform a heat treatment at 150+0/-10°C for one hour and then let sit for 24±2 hours at room temperature. Perform the initial measurement. *Measurement after test Perform a heat treatment and then let sit for 24±2 hours at room temperature, then measure.
		Cap. Change	NP0 within ±7.5% or 0.75pF (whichever is larger)	X5R/X6S/X7R/X7S/X7T/X7U within ±12.5% Y5V within ±30%	
		Q/D.F.	If C > 30pF, DF ≤ 0.5% If C ≤ 30pF, DF ≤ 1/(100+10xC/3) C in pF	X5R/X6S/X7R/X7S/X7T/X7U 200% max of initial spec. Y5V 150% max of initial spec.	
		I.R.	I.R. ≥ 500MΩ or R _C R ≥ 25Ω-F. (whichever is smaller)	I.R. ≥ 500MΩ or R _C R ≥ 25Ω-F. (whichever is smaller)	
16	High temperature load life test	Appearance	No marking defects		Apply 200% of the rated voltage for 1000±12 hours at the maximum operating temperature ± 3 °C. The charge / discharge current is less than 50mA. [Temperature compensation type] Remove and let sit for 24±2 hours at room temperature, then measure. [High dielectric constant type] *Initial measurement Perform a heat treatment at 150+0/-10°C for one hour and then let sit for 24±2 hours at room temperature. Perform the initial measurement. *Measurement after test Perform a heat treatment and then let sit for 24±2 hours at room temperature, then measure.
		Cap. Change	NP0 within ±7.5% or 0.75pF (whichever is larger)	X5R/X6S/X7R/X7S/X7T/X7U within ±12.5% Y5V within ±30%	
		Q/D.F.	If C > 30pF, DF ≤ 0.3% If 10pF < C ≤ 30pF, DF ≤ 1/(275+5xC/2) If C ≤ 10pF, DF ≤ 1/(200+10C), C in pF	X5R/X6S/X7R/X7S/X7T/X7U 200% max of initial spec. Y5V 150% max of initial spec.	
		I.R.	More than 1GΩ or R _C R ≥ 50Ω-F (whichever is less.)	More than 1GΩ or R _C R ≥ 50Ω-F (whichever is less.)	

● General Purpose (II)

Item	Specification	Test Method																																
1	<p>Operation Temperature Range</p> <p>X5R: -55 to 85 °C X6S: -55 to 105 °C X7R/X7S/X7T/X7U: -55 to 125 °C Y5V: -30 to 85 °C</p>	---																																
2	<p>Rated Voltage</p> <p>Shown in the table of "Part Number & Characteristic"</p>	The rated voltage is defined as the maximum voltage, which may be applied continuously to the capacitor.																																
3	<p>Appearance</p> <p>No defects or abnormalities.</p>	Visual inspection																																
4	<p>Dimensions</p> <p>Within the specified dimension.</p>	Using calipers																																
5	<p>Dielectric Strength</p> <p>No defects or abnormalities.</p>	No failure shall be observed when 250% of the rated voltage is applied between the terminations for 1 to 5 seconds. The charge and discharge current is less than 50mA.																																
6	<p>Insulation Resistance (I.R.)</p> <p>$R, C_R \geq 50\Omega\cdot F$</p>	The insulation resistance shall be measured with a DC voltage not exceeding the rated voltage at 25°C and 75%RH max, and within 1 minute of charging, provided the charge/discharge current is less than 50 mA.																																
7	<p>Capacitance</p> <p>Within the specified tolerance * X5R, X6S, X7R, X7S, X7T, X7U and Y5V at 1000 hours</p>	The capacitance / D.F. shall be measured at 25°C at the frequency and voltage shown in the table of "Part Number & Characteristic".																																
8	<p>Q/Dissipation Factor (D.F.)</p> <p>Shown in the table of "Part Number & Characteristic"</p>																																	
9	<p>Capacitance Temperature Characteristics</p> <p>Capacitance change X5R/X7R within ±15% , X6S/X7S within ±22% X7U: -56% to + 22% X7T: -33% to + 22% Y5V: -82% to + 22%</p>	The ranges of capacitance change compared with the 25°C value over the temperature ranges shall be within the specified ranges.																																
10	<p>Termination Strength</p> <p>No removal of the terminations or marking defect.</p>	Apply a parallel force of 5N to a PCB mounted sample for 10±1sec. *2N for 0603 (EIA0201).																																
11	<p>Deflection (Bending Strength)</p> <p>No cracking or marking defects shall occur at 1mm deflection. Capacitance change: X5R, X6S, X7R, X7S, X7T, X7U :within ±12.5% Y5V: within±20%</p> <p>(Unit in mm)</p> <table border="1"> <thead> <tr> <th>Size</th> <th>a</th> <th>b</th> <th>C</th> </tr> </thead> <tbody> <tr> <td>0603</td> <td>0.3</td> <td>0.9</td> <td>0.3</td> </tr> <tr> <td>1005</td> <td>0.4</td> <td>1.5</td> <td>0.5</td> </tr> <tr> <td>1608</td> <td>1.0</td> <td>3.0</td> <td>1.2</td> </tr> <tr> <td>2012</td> <td>1.2</td> <td>4.0</td> <td>1.65</td> </tr> <tr> <td>3216</td> <td>2.2</td> <td>5.0</td> <td>2.0</td> </tr> <tr> <td>4520</td> <td>3.5</td> <td>7.0</td> <td>2.5</td> </tr> <tr> <td>4532</td> <td>3.5</td> <td>7.0</td> <td>3.7</td> </tr> </tbody> </table>	Size	a	b	C	0603	0.3	0.9	0.3	1005	0.4	1.5	0.5	1608	1.0	3.0	1.2	2012	1.2	4.0	1.65	3216	2.2	5.0	2.0	4520	3.5	7.0	2.5	4532	3.5	7.0	3.7	<p>Solder the capacitor to the test jig (glass epoxy boards) shown in Fig.a using a SAC305(Sn96.5Ag3.0Cu0.5) solder (then let sit for 24±2 hours for X5R, X6S, X7R, X7S, X7T, X7U and Y5V).</p> <p>Then apply a force in the direction shown in Fig.b. The soldering shall be done with the reflow method and shall be conducted with care so that the soldering is uniform and free of defects such as heatshock.</p>
Size	a	b	C																															
0603	0.3	0.9	0.3																															
1005	0.4	1.5	0.5																															
1608	1.0	3.0	1.2																															
2012	1.2	4.0	1.65																															
3216	2.2	5.0	2.0																															
4520	3.5	7.0	2.5																															
4532	3.5	7.0	3.7																															
12	<p>Solderability of Termination</p> <p>90% of the terminations are to be soldered evenly and continuously.</p>	Immerse the test capacitor into a methanol solution containing rosin for 3 to 5 seconds, preheat it 150 to 180°C for 2 to 3 minutes and immerse it into SAC305(Sn96.5Ag3.0Cu0.5) solder of 245 ± 5°C for 3±1seconds.																																
13	<p>Resistance to Soldering Heat</p> <p>Appearance No marking defects</p> <p>Cap. Change X5R/X6S/X7R/X7S/X7T/X7U within ±7.5% Y5V within ±20%</p> <p>D.F. To satisfy the specified initial spec.</p> <p>I.R. $R, C_R \geq 50\Omega\cdot F$.</p>	<p>*Preheat the capacitor at 120 to 150°C for 1 minute.</p> <p>Immerse the capacitor in a SAC305(Sn96.5Ag3.0Cu0.5) solder solution at 270±5°C for 10±1 seconds. Let sit at room temperature for 24±2 hours, then measure.</p> <p>* Preheat 150 to 200°C for size ≥3216.</p> <p>* Initial measurement : perform a heat treatment at 150+0/-10°C for one hour and then let sit for 24±2 hours at room temperature. Perform the initial measurement.</p>																																

Item		Specification	Test Method
14	Temperature cycle (Thermal shock)	Appearance	Solder the capacitor to supporting jig (Glass epoxy board) and perform the five cycles according to the four heat treatments listed in the following table. Let sit for 24±2hrs at room temperature, then measure. Step 1: Minimum operating temperature 30±3min Step 2: Room temperature 2-3 min Step 3: Maximum operating temperature 30±3min Step 4: Room temperature 2-3min * Initial measurement: perform a heat treatment at 150±10°C for one hour and then let sit for 24±2 hours at room temp. Perform the initial measurement.
		Cap. Change	
		Q/D.F.	
		I.R.	
15	Humidity load	Appearance	Apply the rated voltage at 40±2°C and 90 to 95% humidity for 500±12 hours. The charge / discharge current is less than 50mA. *Initial measurement Perform a heat treatment at 150+0/-10°C for one hour and then let sit for 24±2 hours at room temperature. Perform the initial measurement. *Measurement after test Perform a heat treatment and then let sit for 24±2 hours at room temperature, then measure.
		Cap. Change	
		Q/D.F.	
		I.R.	
16	High temperature load life test	Appearance	Apply 150% of the rated voltage for 1000±12 hours at the maximum operating temperature ± 3°C. The charge / discharge current is less than 50mA. *Initial measurement Perform a heat treatment at 150+0/-10°C for one hour and then let sit for 24±2 hours at room temperature. Perform the initial measurement. *Measurement after test Perform a heat treatment and then let sit for 24±2 hours at room temperature, then measure. * Some of the parts are applicable in rated voltage *100%. Please refer to "Part Number & Characteristic" with (II)* labeled in "Test Spec."
		Cap. Change	
		D.F.	
		I.R.	

Package

- Tape and reel packaging**

Tape and reel packaging is currently the most promising system for high-speed production. A typical 180mm (7 inch) diameter reel contains 1,500 to 15,000 capacitors, 250mm (10 inch) contains 10,000 capacitors, and 330mm (13 inch) contains 10,000 to 50,000 capacitors. Three standard sizes are available in taped and reeled package either with paper carrier tapes or embossed tapes.

【Paper tape specifications】

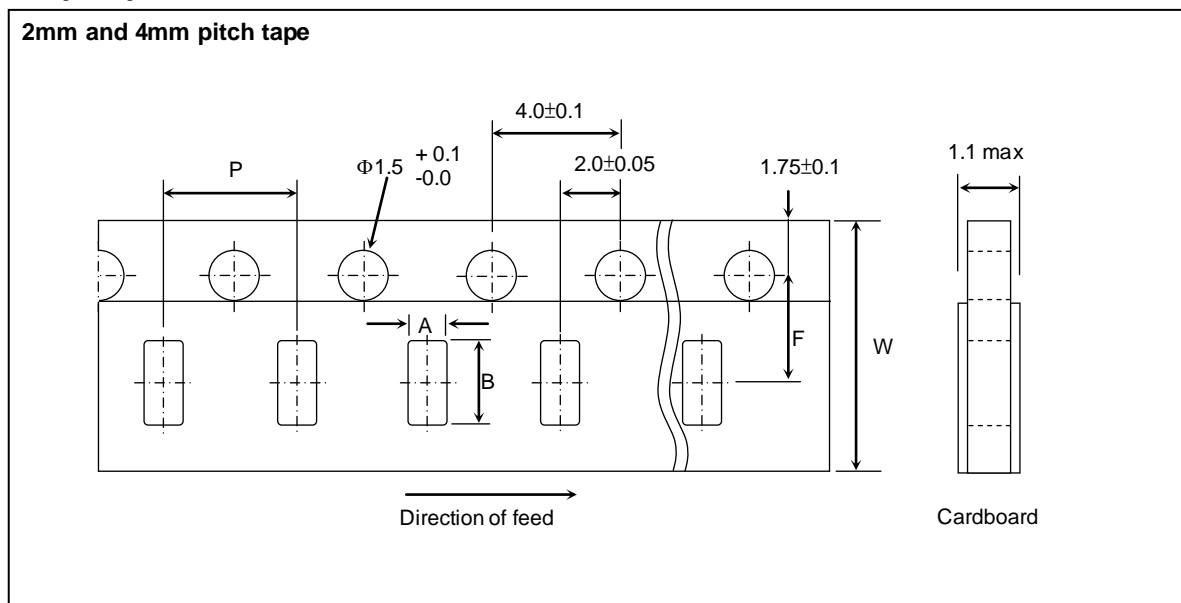

SYMBOL	PRODUCT SIZE CODE										UNIT
	C0603(0201)		C1005(0402) Standard		C1005(0402) Special (1)		C1005(0402) Special (2)		C1005(0402) Special (3)		
	SIZE	TOL.	SIZE	TOL.	SIZE	TOL.	SIZE	TOL.	SIZE	TOL.	
A	0.38	± 0.04	0.65	± 0.10	0.70	± 0.10	0.72	± 0.10	0.80	± 0.10	mm
B	0.68	± 0.04	1.15	± 0.10	1.19	± 0.10	1.25	± 0.10	1.35	± 0.10	mm
F	3.5	± 0.05	3.5	± 0.05	3.5	± 0.05	3.5	± 0.05	3.5	± 0.05	mm
P	2	± 0.10	2	± 0.10	2	± 0.10	2	± 0.10	2	± 0.10	mm
W	8	± 0.20	8	± 0.20	8	± 0.20	8	± 0.20	8	± 0.20	mm

SYMBOL	PRODUCT SIZE CODE (EIA)										UNIT
	C1608(0603) Standard		C1608 (0603) Special (1)		C1608 (0603) Special (2)		C2012 (0805)		C3216 (1206)		
	SIZE	TOL.	SIZE	TOL.	SIZE	TOL.	SIZE	TOL.	SIZE	TOL.	
A	1.0	±0.2	1.0	±0.2	1.1	±0.2	1.5	±0.2	1.9	±0.2	mm
B	1.8	±0.2	1.8	±0.2	1.9	±0.2	2.3	±0.2	3.6	±0.2	mm
F	3.5	±0.05	3.5	±0.05	3.5	±0.05	3.5	±0.05	3.5	±0.05	mm
P	4	±0.1	4	±0.1	4	±0.1	4	±0.1	4	±0.1	mm
W	8	±0.2	8	±0.2	8	±0.2	8	±0.2	8	±0.2	mm

【 Embossed tape specifications 】

1mm and 4mm and 8mm pitch tape

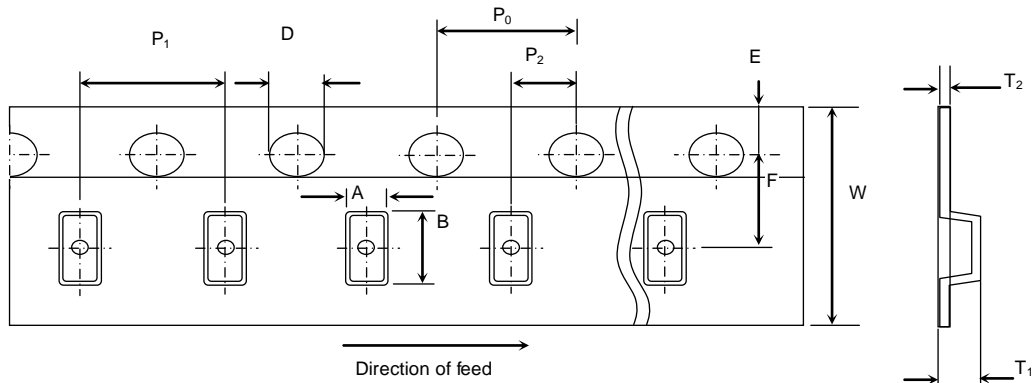

For $W=8\text{mm}$: $T_1=2.5\text{mm max.}$

For $W=12\text{mm}$: $T_1=4.5\text{mm}$

DIMENSION (mm)	PRODUCT SIZE CODE					
	4 mm tape				8 mm tape	
	1608 (0603)	2012 (0805)	3216 (1206)	3225 (1210)	4520 (1808)	4532 (1812)
P_1	4 ± 0.1	4 ± 0.1	4 ± 0.1	4 ± 0.1	8 ± 0.1	8 ± 0.1
P_0	4 ± 0.1	4 ± 0.1	4 ± 0.1	4 ± 0.1	4 ± 0.1	4 ± 0.1
P_2	2 ± 0.05	2 ± 0.05	2 ± 0.05	2 ± 0.05	2 ± 0.05	2 ± 0.05
A	1.2 ± 0.2	1.45 ± 0.2	1.9 ± 0.2	2.8 ± 0.2	2.3 ± 0.2	3.6 ± 0.2
B	2.0 ± 0.2	2.3 ± 0.2	3.5 ± 0.2	3.6 ± 0.2	4.9 ± 0.2	4.9 ± 0.2
W	8 ± 0.3	8 ± 0.2	8 ± 0.2	8 ± 0.2	12 ± 0.2	12 ± 0.2
E	1.75 ± 0.1	1.75 ± 0.1	1.75 ± 0.1	1.75 ± 0.1	1.75 ± 0.1	1.75 ± 0.1
F	3.5 ± 0.05	3.5 ± 0.05	3.5 ± 0.05	3.5 ± 0.05	5.5 ± 0.05	5.5 ± 0.05
D	1.5 (+0.1/-0.0)	1.5 (+0.1/-0.0)	1.5 (+0.1/-0.0)	1.5 (+0.1/-0.0)	1.5 (+0.1/-0.0)	1.5 (+0.1/-0.0)
T_1	1.4 max.	2.5 max.	2.5 max.	2.5 max.	4.5	4.5
T_2	0.25 ± 0.1	0.305 ± 0.1	0.30 ± 0.1	0.30 ± 0.1	0.30 ± 0.1	0.30 ± 0.1

【 Reel specifications 】

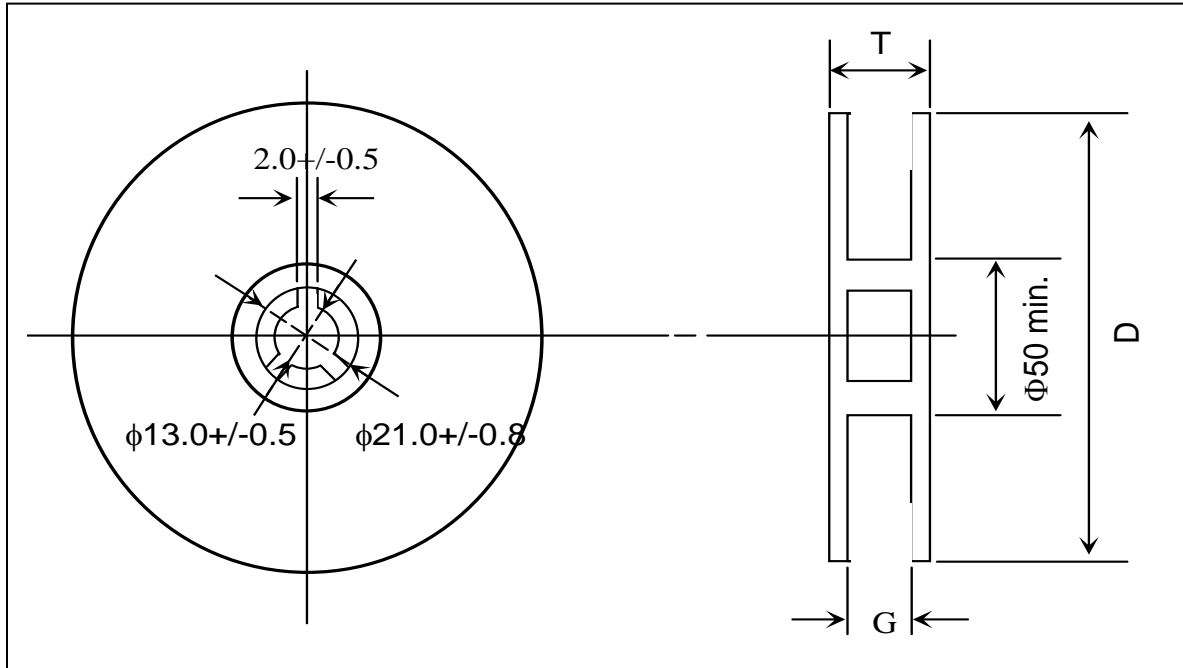

TAPE WIDTH (mm)	G (mm)	T max. (mm)	D (mm)
4	5.0 ± 1.5	8.0	180
8	10.0 ± 1.5	14.5	180
8	10.0 ± 1.5	14.5	250
8	10.0 ± 1.5	14.5	330
12	14.0 ± 1.5	18.5	180

【 Thickness and Packing Amount 】

Thickness			Amount per reel			
Code	Spec.(mm)	Size (EIA)	180 mm (7")		330 mm (13")	
			Paper	Embossed	Paper	Embossed
Z	0.20	0402 (01005)	20K	40K ^{#1}		
A	0.30	0603 (0201)	15K		50K	
		1005 (0402)	15K		50K	
B	0.50	1005 (0402)	10K		50K	
Q	0.45	1005 (0402)	10K		50K	
		1608 (0603)	4K		15K	
C	0.60	2012 (0805)	4K		15K	
		3216 (1206)	4K		15K	
D	0.80	1608 (0603)	4K	4K	15K	
E	0.85	2012 (0805)	4K		15K	
		3216 (1206)	4K		15K	
		3225 (1210)		3K		10K
I	0.95	4532 (1812)		1K		
		2012 (0805)		3K		
F	1.15	3216 (1206)		3K		10K
		4520 (1808)		3K		
G	1.25	2012 (0805)		2K/3K		10K
		3216 (1206)		3K		10K
		3225 (1210)		3K		
		4520 (1808)		2K/3K		
		4532 (1812)		1K		
		3225 (1210)		3K		
L	1.60	3216 (1206)		2K		
		3225 (1210)		2K		
		4520 (1808)		2K		
		4532 (1812)		1K		
N	2.00	3216 (1206)		2K/3K		
		3225 (1210)		1K/2K		
		4520 (1808)		1K		
		4532 (1812)		1K		
P	2.50	3225 (1210)		500pcs/1K		

#1: 4mm width 1mm pitch Embossed Taping

【 Packing Rule 】

EIA SIZE	Tape	Reel Size	Reels/Box	Boxes/ Carton
01005	Emboss	7"	8	12
01005	Paper	7"	5	12
0201	Paper	7"	5	12
0402	Paper	7"	5	12
0603	Paper/Emboss	7"	5	12
0805	Paper/Emboss	7"	5	12
1206	Paper/Emboss	7"	5	12
1210	Emboss	7"	5	12
1808	Emboss	7"	5	12
1812	Emboss	7"	5	12

Others

【Storage】

1. The chip capacitors shall be packaged in carrier tapes or bulk cases.
2. Keep storage place temperatures from +5°C to +35°C, humidity from 45 to 70% RH.
3. The storage atmosphere must be free of gas containing sulfur and chlorine. Also, avoid exposing the product to saline moisture. If the product is exposed to such atmospheres, the terminations will oxidize and solderability will be affected.
4. The solderability is assured for 12 months from our final inspection date if the above storage condition is followed.

【Circuit Design】

1. Once application and assembly environments have been checked, the capacitor may be used in conformance with the rating and performance, which are provided in both the catalog and the specifications. Exceeding the specifications listed may result in inferior performance. It may also cause a short, open, smoking, or flaming to occur, etc.
2. Please use the capacitors in conformance with the operating temperature provided in both the catalog and the specifications. Be especially cautious not to exceed the maximum temperature. In the situation the maximum temperature set forth in both the catalog and specifications is exceeded, the capacitor's insulation resistance may deteriorate, power may suddenly surge and short-circuit may occur. The loss of capacitance will occur, and may self-heat due to equivalent series resistance when alternating electric current is passed through. As this effect becomes critical in high frequency circuits, please exercise with caution. When using the capacitor in a (self-heating) circuit, please make sure the surface of the capacitor remains under the maximum temperature for usage. Also, please make certain temperature rise remain below 20°C.
3. Please keep voltage under the rated voltage, which is applied to the capacitor. Also, please make certain the peak voltage remains below the rated voltage when AC voltage is super-imposed to the DC voltage. In the situation where AC or pulse voltage is employed, ensure average peak voltage does not exceed the rated voltage. Exceeding the rated voltage provided in both catalog and specifications may lead to defective withstanding voltage or, in worse case situations, may cause the capacitor to burn out.
4. It's is a common phenomenon of high-dielectric products to have a deteriorated amount of static electricity due to the application of DC voltage.

【Handling】

Chip capacitors should be handled with care to avoid contamination or damage. The use of vacuum pick-up or plastic tweezers is recommended for manual placement. Tape and reeled packages are suitable for automatic pick and placement machine.

【Flux】

1. An excessive amount of flux or too rapid temperature rise can cause solvent burst, solder can generate a large quantity of gas. The gas can spread small solder particles to cause solder balling effect or bridging problem.
2. Flux containing too high of a percentage of halide may cause corrosion of termination unless sufficient cleaning is applied.
3. Use rosin-type flux. Highly acidic flux (halide content less than 0.2wt%) is not recommended.
4. The water soluble flux causes deteriorated insulation resistance between outer terminations unless sufficiently cleaned.

【Component Spacing】

For wave soldering components, the spacing must be sufficient far apart to prevent bridging or shadowing. This is not so important for reflow process but enough space for rework should be considered. The suggested spacing for reflow soldering and wave soldering is 0.5mm and 1.0mm, respectively.

【Solder Fillet】

Too much solder amount may increase solder stress and cause crack risk. Insufficient solder amount may reduce adhesive strength and cause parts falling off PCB. When soldering, confirm that the solder is placed over 0.2mm of the surface of the terminations.

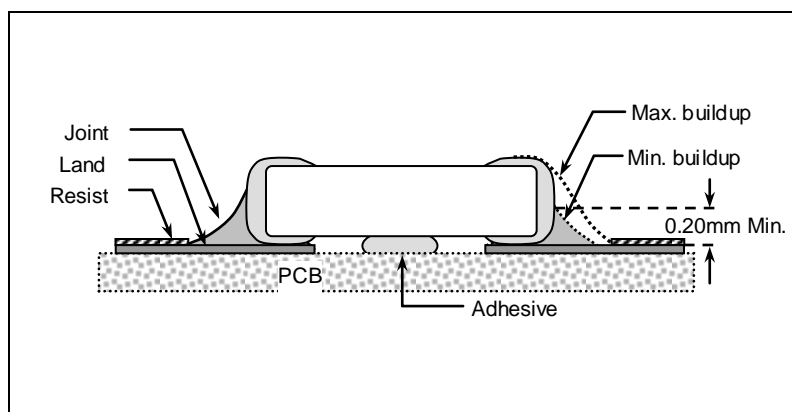

【Recommended Land Pattern Dimensions】

When mounting the capacitor to substrate, it's important to consider that the amount of solder (size of fillet) used has a direct effect upon the capacitor once it's mounted.

1. The greater the amount of solder, the greater the stress to the elements, as this may cause the substrate to break or crack.
2. In the situation where two or more devices are mounted onto a common land, separate the device into exclusive pads by using soldering resist.
3. Land width equal to or less than component. It is permissible to reduce land width to 80% of component width.

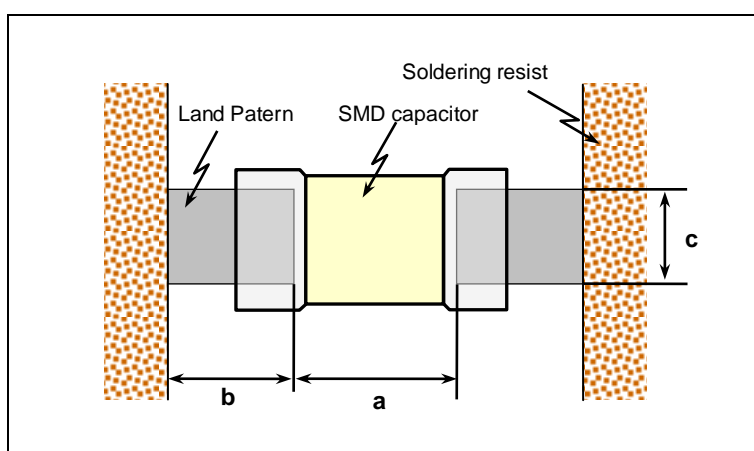

Size mm (EIA)	L x W (mm) (Dimension tolerance)	a (mm)	b (mm)	c (mm)
0402 (01005)	0.4*0.2	0.16 to 0.20	0.12 to 0.18	0.20 to 0.23
0603 (0201)	0.6*0.3	0.15 to 0.35	0.2 to 0.3	0.25 to 0.3
1005 (0402)	1.0*0.5 (within±0.10)	0.3 to 0.5	0.35 to 0.45	0.4 to 0.5
	1.0*0.5 (±0.15 or ±0.20)	0.4 to 0.6	0.4 to 0.5	0.5 to 0.6
1608 (0603)	1.6*0.8 (within±0.10)	0.7 to 1.0	0.6 to 0.8	0.7 to 0.8
	1.6*0.8 (±0.15 or ±0.20)	0.8 to 1.1	0.7 to 0.9	0.8 to 0.9
2012 (0805)	2.0*1.25	1.0 to 1.3	0.7 to 0.9	1.0 to 1.2
3216 (1206)	3.2*1.6	2.1 to 2.5	1.0 to 1.2	1.3 to 1.6
3225 (1210)	3.2*2.5	2.1 to 2.5	1.0 to 1.2	2.0 to 2.5
4520 (1808)	4.5*2.0	3.2 to 3.8	1.2 to 1.4	1.7 to 2.0
4532 (1812)	4.5*3.2	3.2 to 3.8	1.2 to 1.4	2.7 to 3.2

【Resin Mold】

If a large amount of resin is used for molding the chip, cracks may occur due to contraction stress during curing. To avoid such cracks, use a low shrinkage resin. The insulation resistance of the chip will degrade due to moisture absorption. Use a low moisture absorption resin. Check carefully that the resin does not generate a decomposition gas or reaction gas during the curing process or during normal storage. Such gases may crack the chip capacitor or damage the device itself.

【Soldering Profile for SMT Process with SnPb Solder Paste】

Reflow Soldering

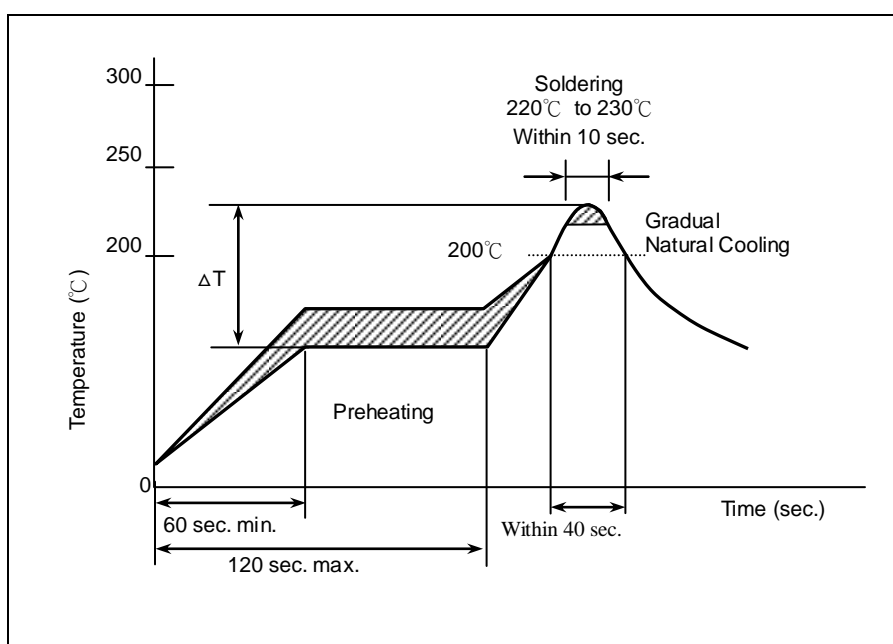

The difference between solder and chip surface should be controlled as following table. The rate of preheat should not exceed 4°C/sec and a target of 2°C/sec is preferred.

Chip Size	3216 and smaller	3225 and above
Preheating	$\Delta T \leq 150^\circ\text{C}$	$\Delta T \leq 130^\circ\text{C}$

Wave Soldering

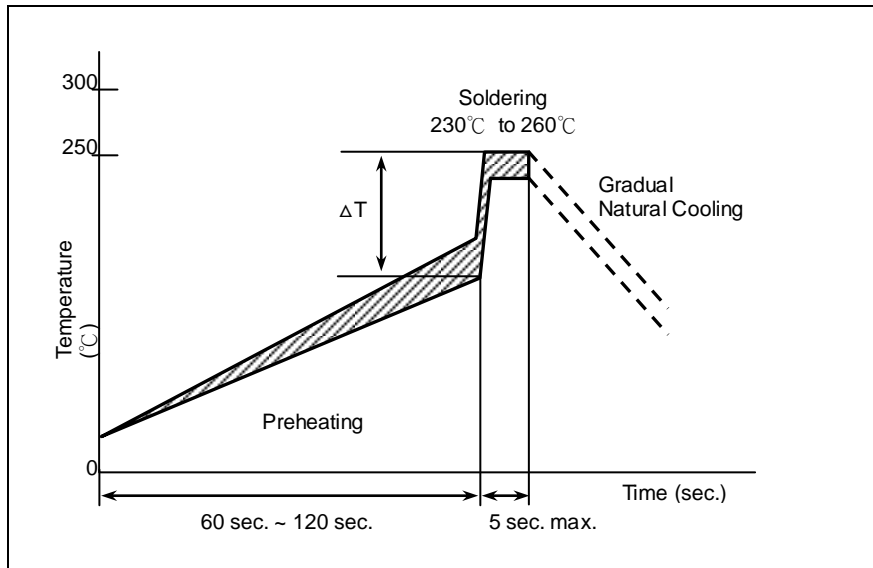

Chip Size	3216 and smaller	3225 and above
Preheating	$\Delta T \leq 150^{\circ}\text{C}$	-

Soldering Iron

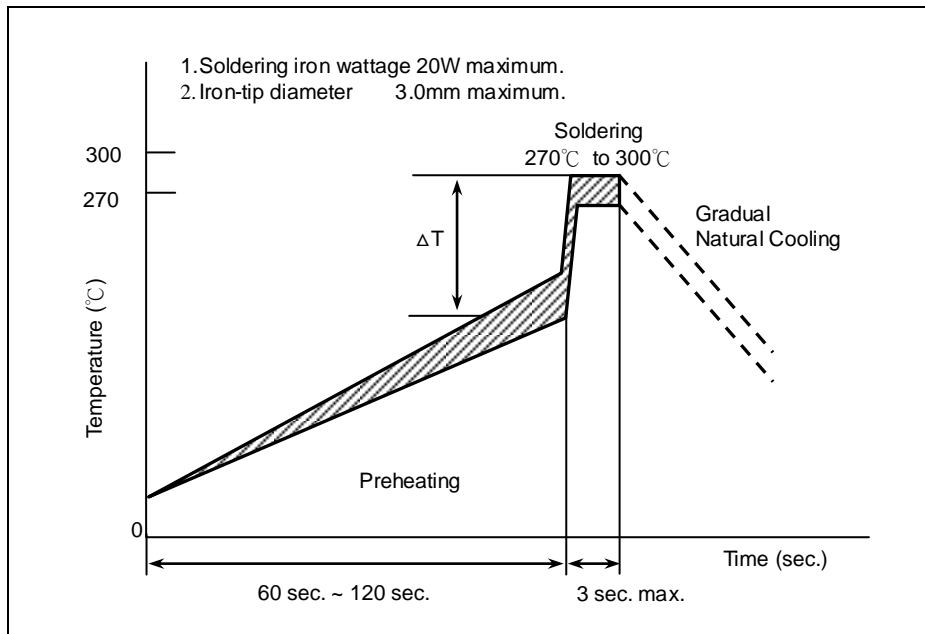

Chip Size	3216 and smaller	3225 and above
Preheating	$\Delta T \leq 190^{\circ}\text{C}$	$\Delta T \leq 130^{\circ}\text{C}$

MLCC

[Soldering]

Reflow Soldering for Lead free Termination

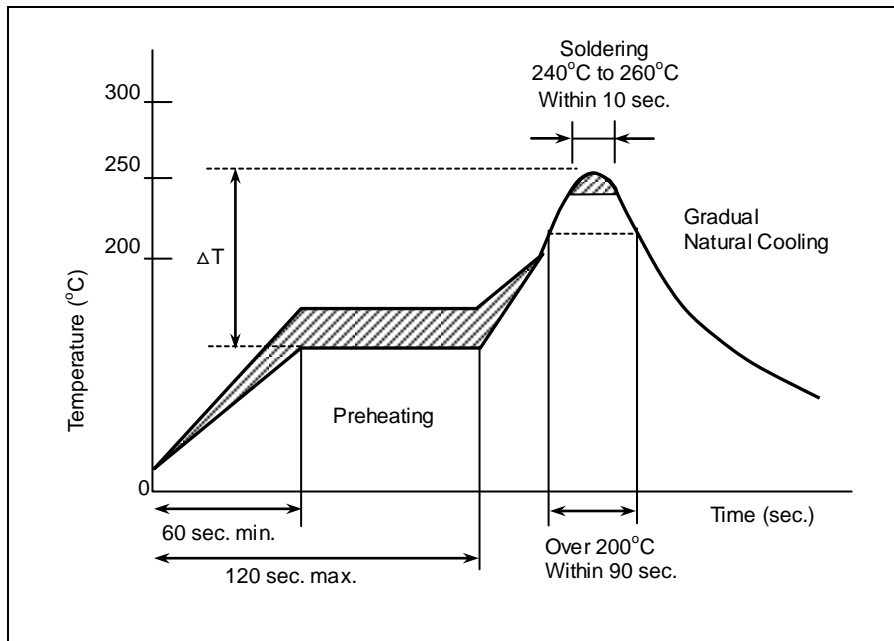

The difference between solder and chip surface should be controlled as following table. The rate of preheat should not exceed 4°C/sec and a target of 2°C/sec is preferred.

Chip Size	3216 and smaller	3225 and above
Preheating	$\Delta T \leq 150^\circ\text{C}$	$\Delta T \leq 130^\circ\text{C}$

Flow Soldering for Lead free Termination

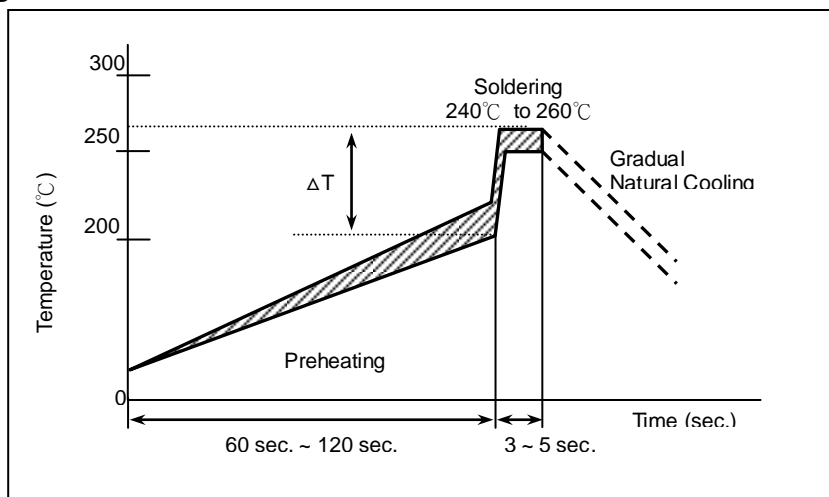

Chip Size	3216 and smaller	3225 and above
Preheating	$\Delta T \leq 150^\circ\text{C}$	-

Soldering Iron

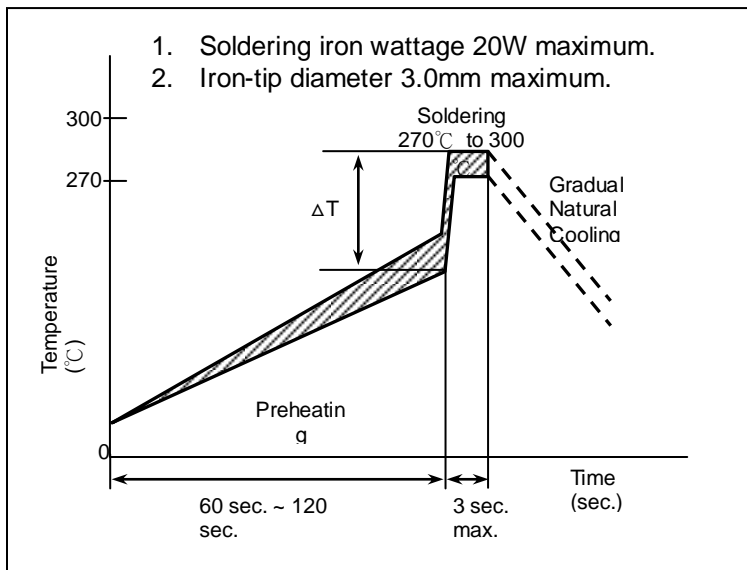

Chip Size	3216 and smaller	3225 and above
Preheating	$\Delta T \leq 190^{\circ}\text{C}$	$\Delta T \leq 130^{\circ}\text{C}$

【Chip Layout and Breaking PCB】

- To layout the SMD capacitors for reducing bend stress from board deflection of PCB. The following are examples of Hood and bad layout.

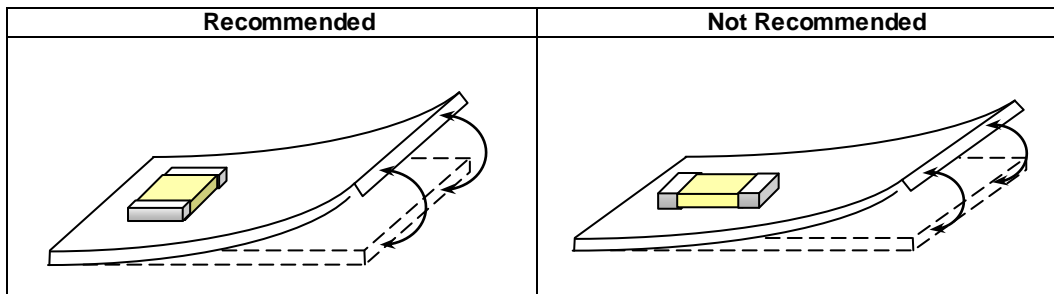

- When breaking PCB, the layout should be noted that the mechanical stresses are depending on the position of capacitors. The following example shows recommendation for better design.

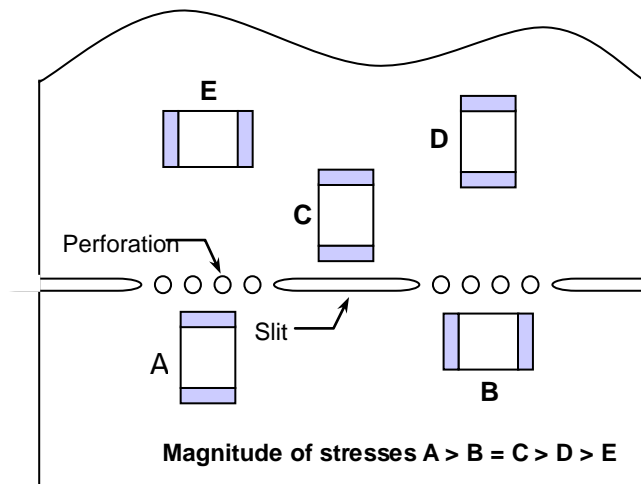

【Temperature Coefficient】

- Class 1 (Temperature Compensation series)

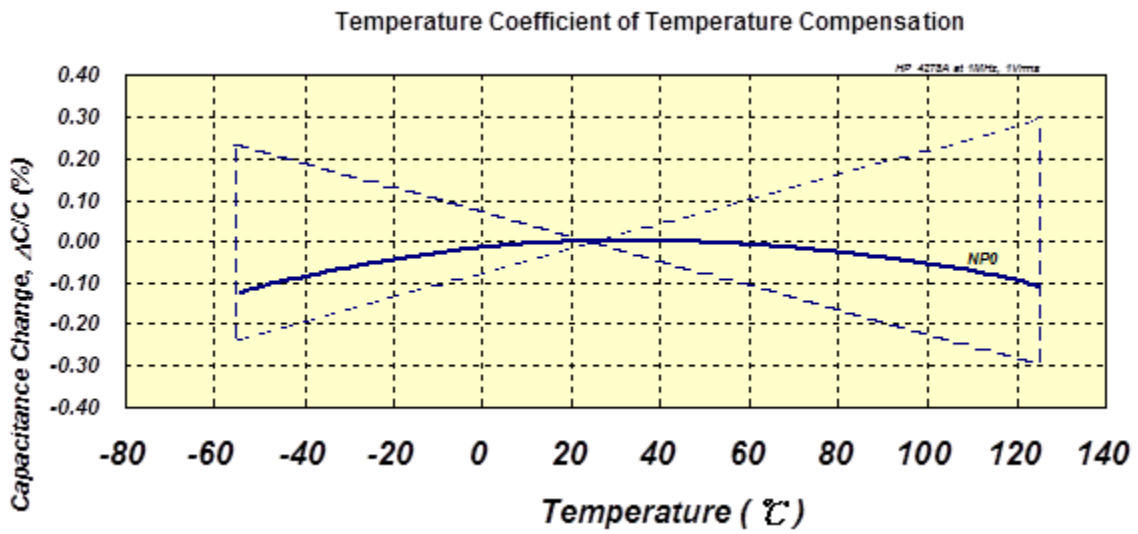

- Class 2 (High Dielectric Constant Series)

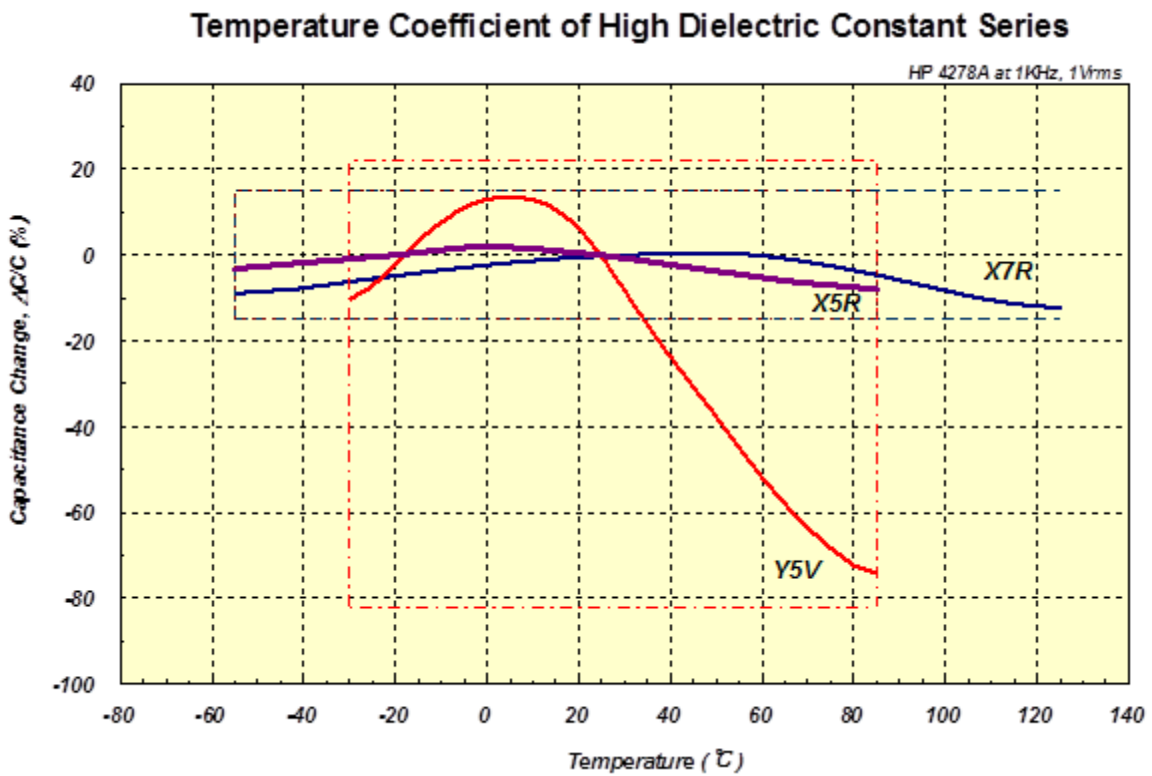

【DC Voltage Coefficient】

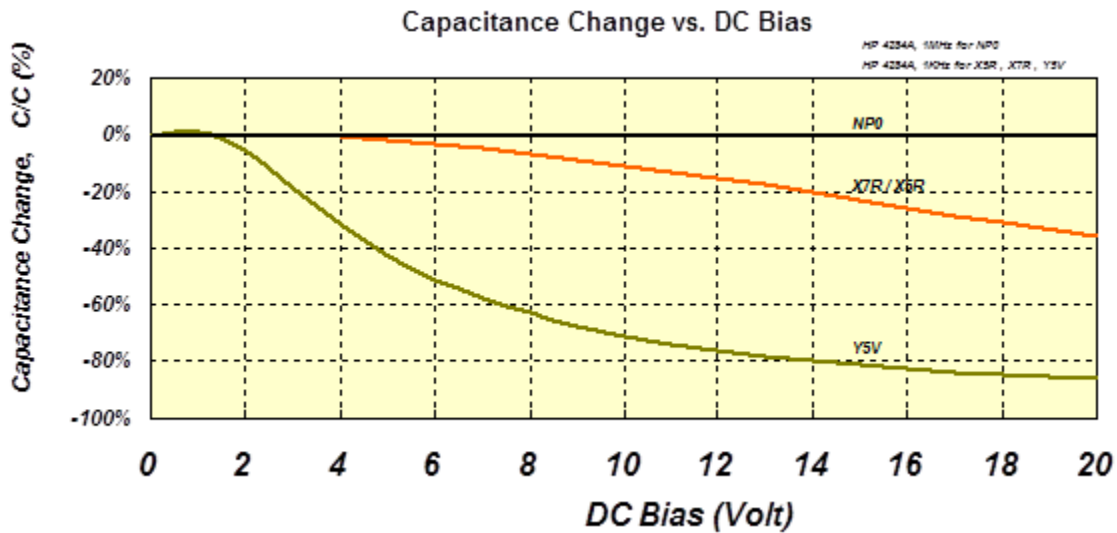

【Aging Rate】

The capacitance and dissipation factor of class 2 capacitors decreases with time. It is known as 'aging' that follows a logarithmic law and expressed in terms of an aging constant. Aging is caused by a gradual re-alignment of the crystalline structure of the ceramic. The aging constant is defined as the percentage loss of capacitance at a 'time decade'. The law of capacitance aging is expressed as following equation:

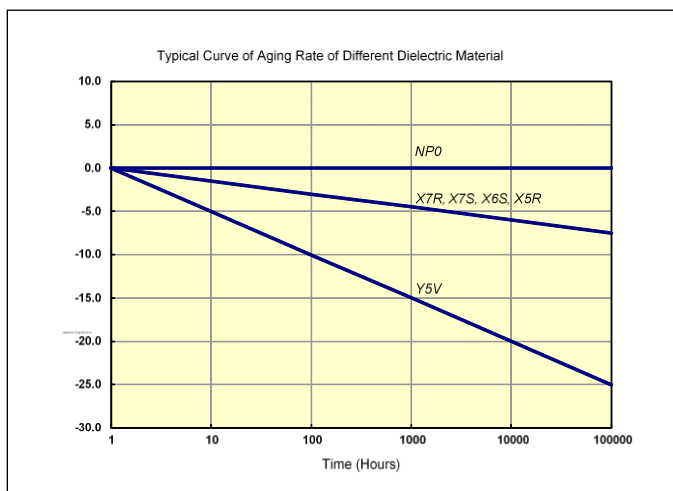

$$C_{t2} = C_{t1} \times (1 - k \times \log_{10}(t_2/t_1))$$

C_{t1} : Capacitance after t_1 hours of start aging.

C_{t2} : Capacitance after t_2 hours of start aging.

k : aging constant (capacitance decrease per decade)

t_1, t_2 : time in hours from start of aging.

A typical curve of aging rate is shown in following figure.

When heating the capacitors above Curie temperature ($130^{\circ}\text{C} \sim 150^{\circ}\text{C}$) the capacitance can be re-new. So capacitance of class 2 capacitors will be complete de-aged by soldering process; subsequently a new aging process begins.

Because of aging, it is specified an age for measurement to meet the prescribed tolerance for class 2 capacitors. Normally, 1000 hours ($t_2=1000$ hrs) is defined.

【Peeling Off Force】

Peeling off force: 0.1N to 1.0 N* in the direction shown as below.

The peeling speed: 300±10 mm/min

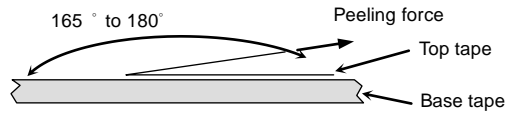

1. The taped tape on reel is wound clockwise. The sprocket holes are to the right as the tape is pulled toward the user.
2. There are minimum 150 mm as the leader and minimum 40 mm empty tape as the tail is attached to the end of the tape.