

Schemazeichnung mit Hauptabmessungen/Drawing with principal dimensions

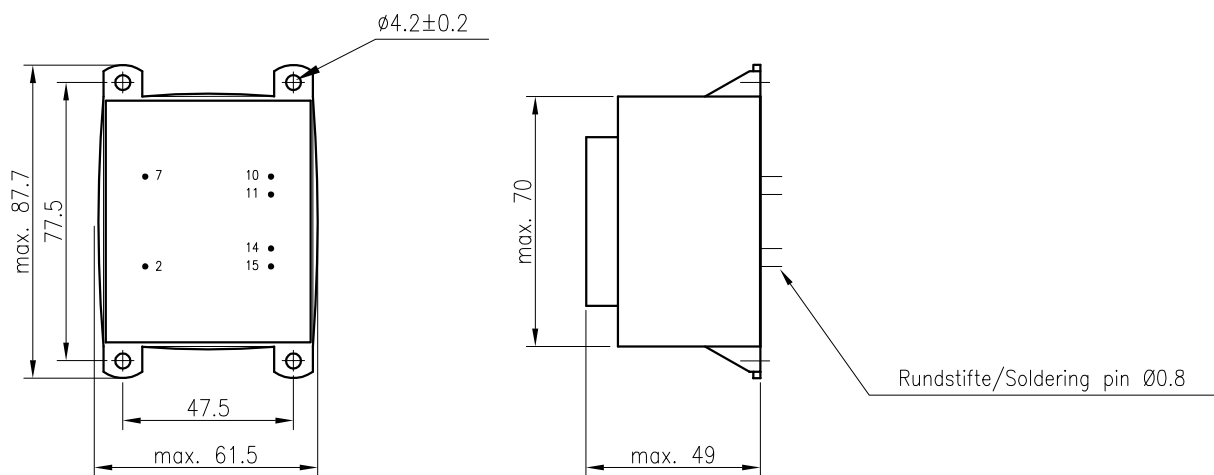

Anschlussschema/Scheme:

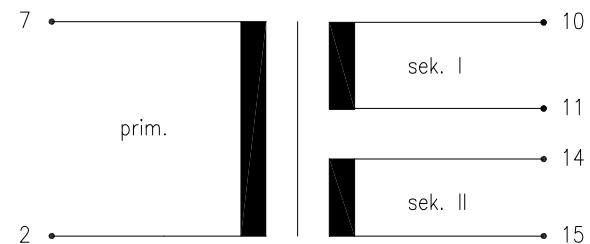

Elektrische Daten/Electrical Data:

prim.:	230V	50-60Hz	2-7
sek. I:	12V	15VA	10-11
sek. II:	12V	15VA	14-15
Temp.-Klasse/class:	ta 70°C/B		
nicht kurzschlußfest/non short-circuit-proof			



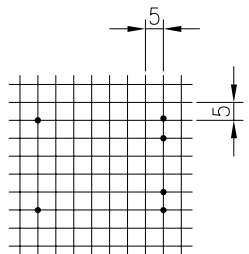

Raster/Grid:

Ansicht: Stiftseite/View: pinside



Kennzeichnung/Identification:

Tampondruck/Pad printing

prim 230V 50-60Hz 2-7
 BV EI 662 4043
 ta 70°C/B
 HAHN    

Extern: 2x  sek 1,25AT
 sekI 12V 15VA 10-11
 sekII 12V 15VA 14-15

01	28.02.2008	Änderungstext	sas/pbl	
 HAHN GmbH & Co. KG				
Transformator			BV EI 662 4043	
Maße ohne Toleranzangabe ±0,3/Dimensions without tolerances ±0,3mm Unterliegt nicht dem Änderungsdienst/Is not liable to the changing service				
Erstellt:	27.11.2012	Beuermann	Kunde	Schukat
Geprüft:	27.11.2012	J.Schmitt	Ort:	Monheim
Maßstab:	1:2		Z.Nr.:	8822
Typ:	EI 66/23	--kk--	Projekt/Art-Nr.:	
F:\QM\CAD\TRAFO-EI\VERG\EI-66\662\BV-EI-662-4043-Schukat				